

**SCVD STEEL CURVED VANE DIFFUSER**

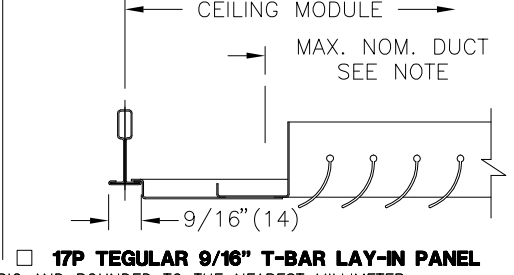

**1 WAY**

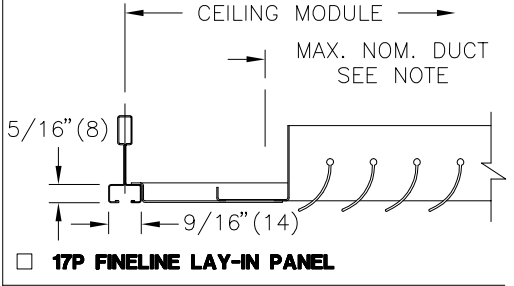
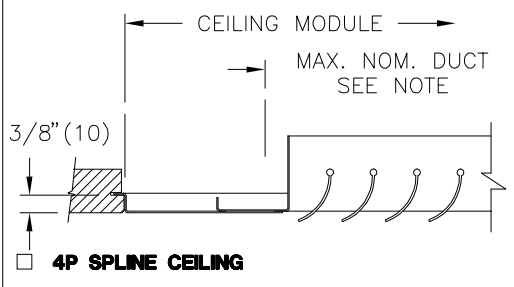
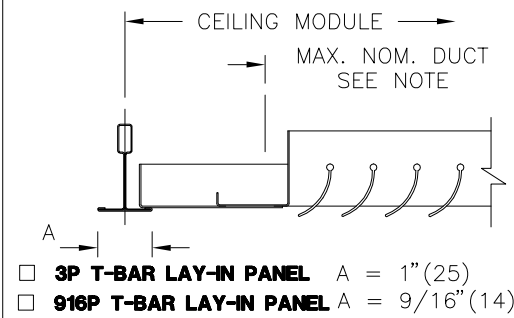
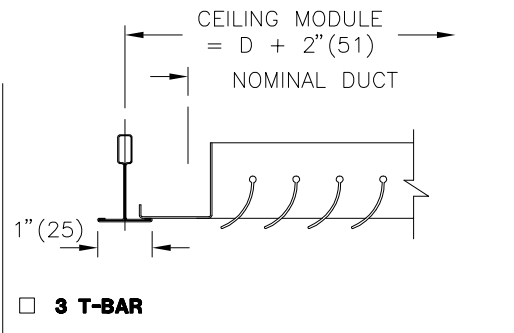
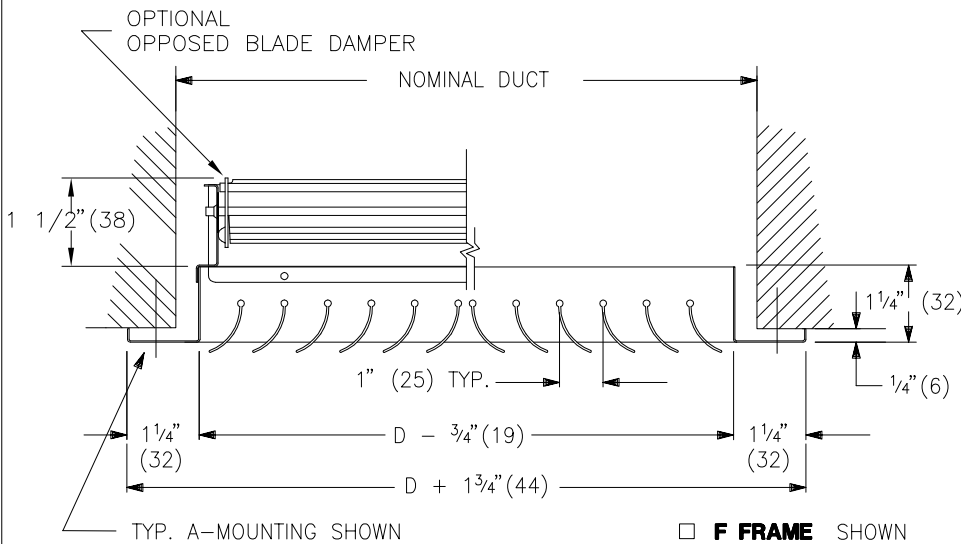
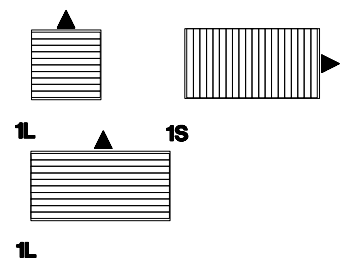

**2 WAY**

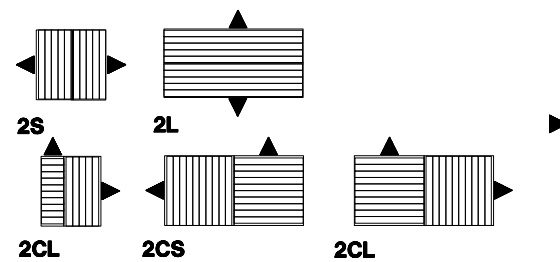

**3 WAY**

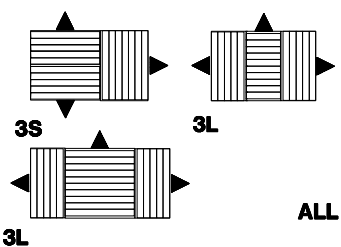

**4 WAY**

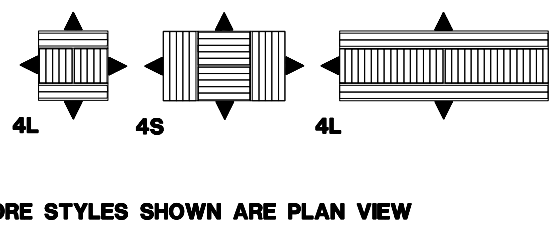

ALL CORE STYLES SHOWN ARE PLAN VIEW

**MATERIAL:**

- STEEL

**FINISH:**

- B12 WHITE (OPTIONAL FINISHES AVAILABLE)

**NOTE:**

SIZES 6x4 TO 24x24 AVAILABLE IN 1, 2, 3 & 4 WAY AIR PATTERNS, EXCEPT ALL 4\"/>

AVAILABLE PANEL SIZES: 12x12, 24x24, 48x24, 300x300, 600x600, 1200x600 FOR 3P, 916P, 4P AND 17P MAX. NOM. DUCT SIZE = CM - 4\"/>

**OPTION:**

- VCS3 c/w COATED STEEL OPPOSED BLADE DAMPER

ALL METRIC DIMENSIONS ( ) ARE SOFT CONVERTED. IMPERIAL DIMENSIONS ARE CONVERTED TO METRIC AND ROUNDED TO THE NEAREST MILLIMETER.

**PROJECT:**

**ENGINEER:**

**CUSTOMER:**

**SUBMITTAL DATE:**

**SPEC. SYMBOL:**



*Handwritten signature*

**SCVD**

STEEL CURVED VANE  
SUPPLY AIR DIFFUSER

227336

2014/06/24