

**LEGEND**

- FACTORY FLOW SENSOR TUBING
- FACTORY ELECTRICAL WIRING
- FIELD ELECTRICAL WIRING

**CONTROL GRAPH**

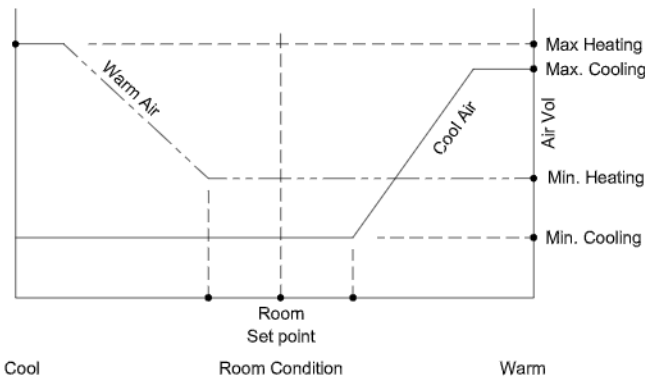

**Sequence of Operation -- Heat/cool changeover OR cooling only Pressure Independent**

On power up the damper will calibrate closed for 2 minutes.

**\*\*If no SAT sensor is present, the controller assumes Cool supply air at all times\*\***

**Cool supply air:** On an increase in space temperature the controller regulates the actuator to open the VAV damper and increase the flow of cool air. On an increase of space temperature greater than the cooling proportional band, the airflow is maintained at its pre-selected maximum setting.

On a decrease in space temperature the controller regulates the actuator to close the VAV damper and reduce the flow of cool air. If the space temperature decreases to less than the cooling proportional band, the airflow is maintained at the pre-selected minimum setting.

**Warm supply air:** On a decrease in space temperature the controller regulates the actuator to open the VAV damper and increase the flow of warm air. On a decrease of space temperature greater than the heating proportional band, the airflow is maintained at its pre-selected maximum setting.

On an increase in space temperature the controller regulates the actuator to close the VAV damper and reduce the flow of warm air. If the space temperature increases above the heating proportional band, the airflow is maintained at the pre-selected minimum setting.

**PROJECT:**

**ENGINEER:**

**CUSTOMER:**

**SUBMITTAL DATE:**

**SPEC. SYMBOL:**

	<b>SINGLE DUCT PIC DDC</b>
249530	PRESSURE INDEPENDENT HEAT/COOL CHANGEOVER OR COOLING ONLY NO LOCAL REHEAT CONTROL
2017/06/21	

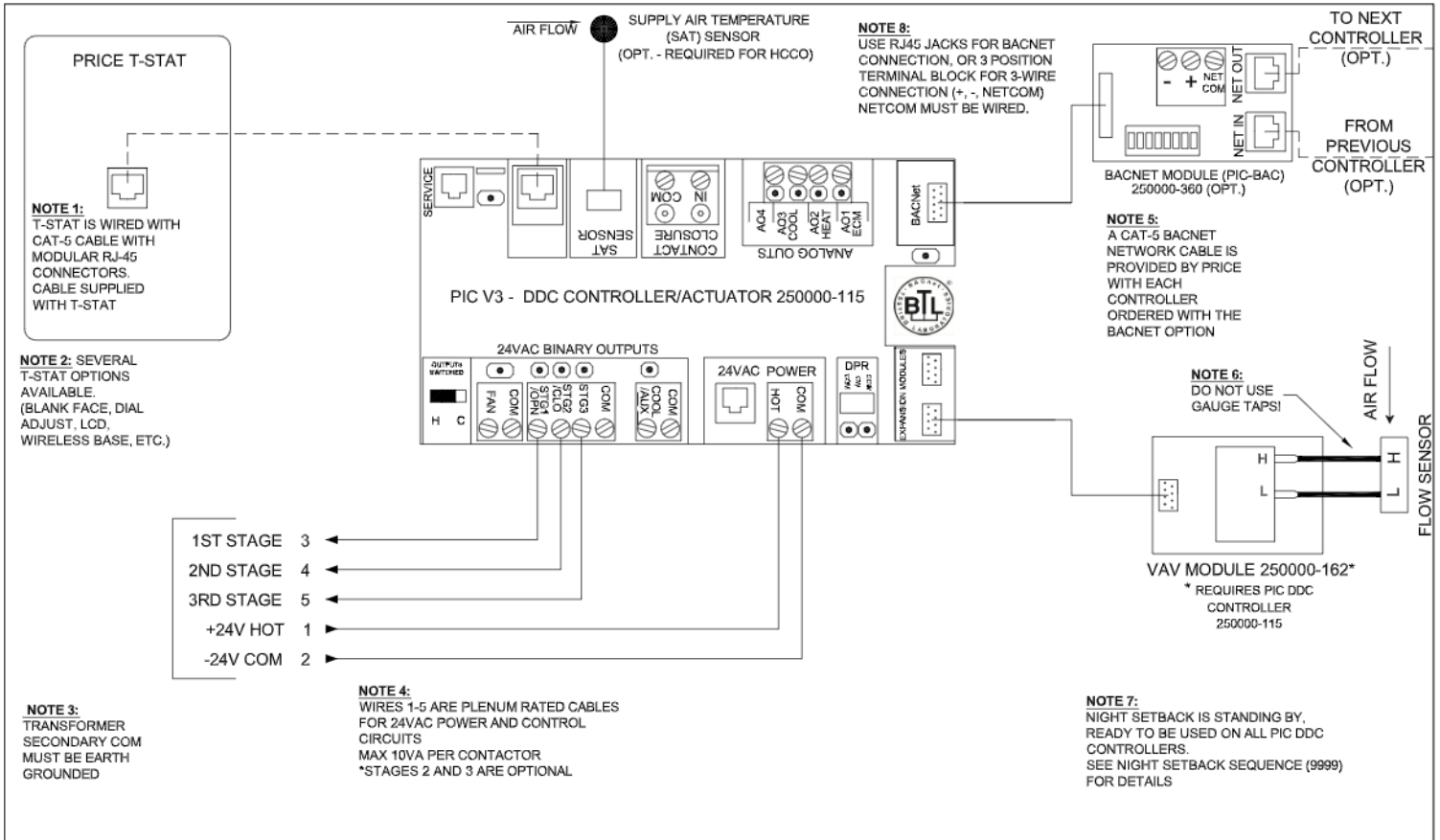

**Calibration note:** Suitable min and max heating flows must be selected in order to maintain flow through energized electric coils of at least 200 fpm and at least 70 cfm/kW throughout the entire operating range.

- LEGEND**
- FACTORY FLOW SENSOR TUBING
  - FACTORY ELECTRICAL WIRING
  - - - - - FIELD ELECTRICAL WIRING

**CONTROL GRAPH**

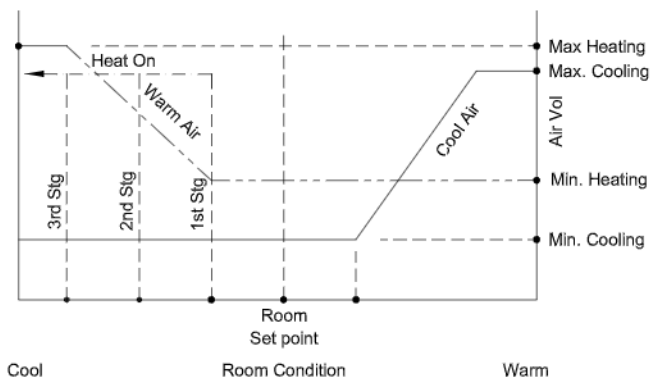

**Sequence of Operation -- Heat/cool changeover OR cooling  
With up to 3 stage binary reheat - Pressure Independent**

On power up the damper will calibrate closed for 2 minutes.  
\*\*If no SAT sensor is present, the controller assumes Cool supply air at all times\*\*

**Cool supply air:** On an increase in space temperature the controller regulates the actuator to open the VAV damper and increase the flow of cool air. On an increase of space temperature greater than the cooling proportional band, the airflow is maintained at its pre-selected maximum setting.

On a decrease in space temperature the controller regulates the actuator to close the VAV damper and reduce the flow of cool air. If the space temperature decreases to less than the cooling proportional band, the airflow is maintained at the pre-selected minimum setting.

**Warm supply air:** On a decrease in space temperature the controller regulates the actuator to open the VAV damper and increase the flow of warm air. On a decrease of space temperature greater than the heating proportional band, the airflow is maintained at its pre-selected maximum setting.

On an increase in space temperature the controller regulates the actuator to close the VAV damper and reduce the flow of warm air. If the space temperature increases above the heating proportional band, the airflow is maintained at the pre-selected minimum setting.

**Reheat Operation:** On a decrease in space temperature into the heating proportional band, the 1st stage binary 24VAC reheat output will energize. Upon further decreases, the 2nd then 3rd stages of reheat (if used) will energize.

<b>PROJECT:</b>		<b>PRICE</b> <sup>®</sup>	
<b>ENGINEER:</b>			
<b>CUSTOMER:</b>		<b>SINGLE DUCT PIC DDC</b>	
<b>SUBMITTAL DATE:</b>		PRESSURE INDEPENDENT HEAT/COOL C/O OR COOLING WITH UP TO 3 STG BINARY REHEAT FACTORY WIRED	
<b>SPEC. SYMBOL:</b>		249531	
		2017/06/23	

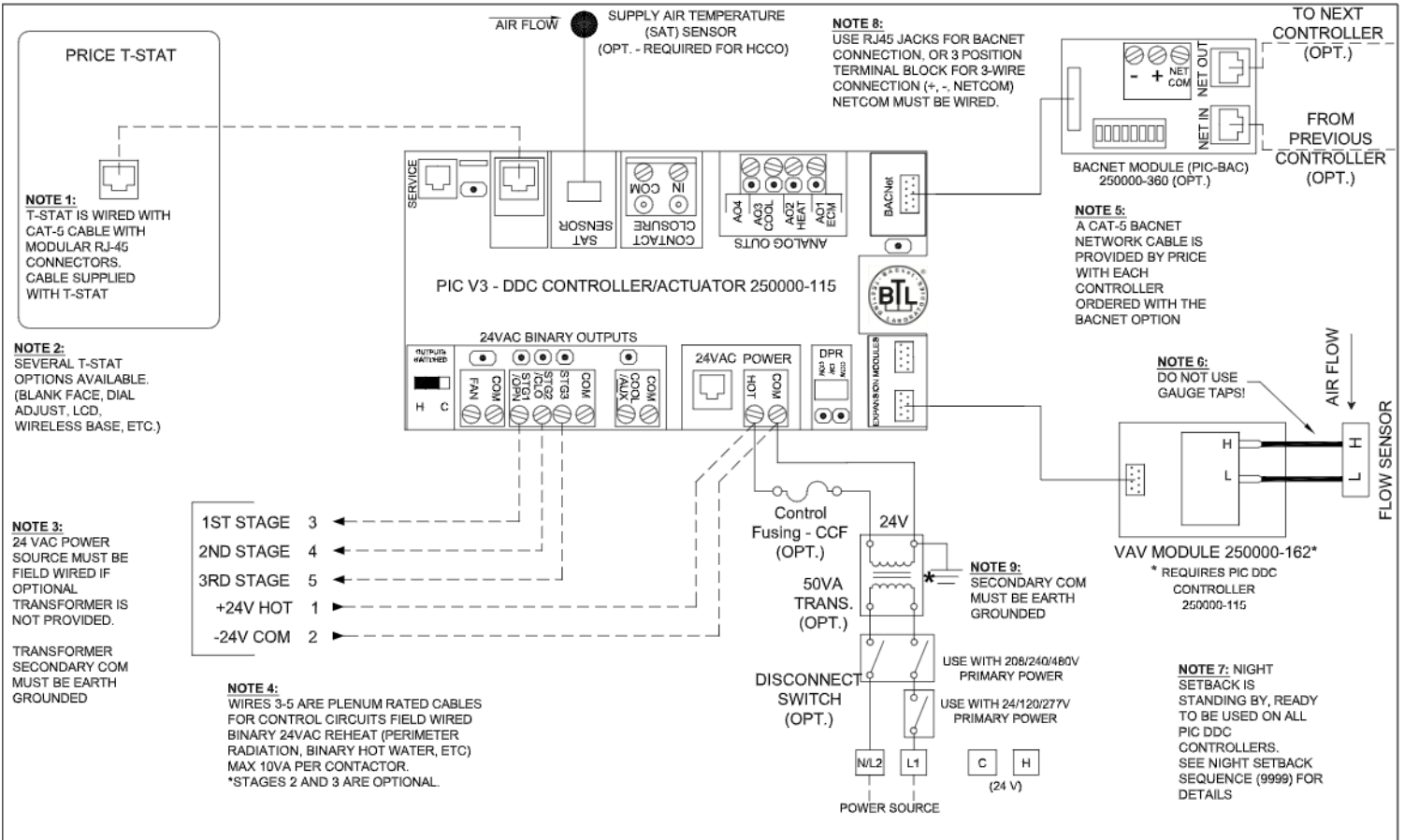

**Calibration note:** Suitable min and max heating flows must be selected in order to maintain flow through energized electric coils of at least 200 fpm and at least 70 cfm/kW throughout the entire operating range.

**LEGEND**

- FACTORY FLOW SENSOR TUBING
- FACTORY ELECTRICAL WIRING
- FIELD ELECTRICAL WIRING

**CONTROL GRAPH**

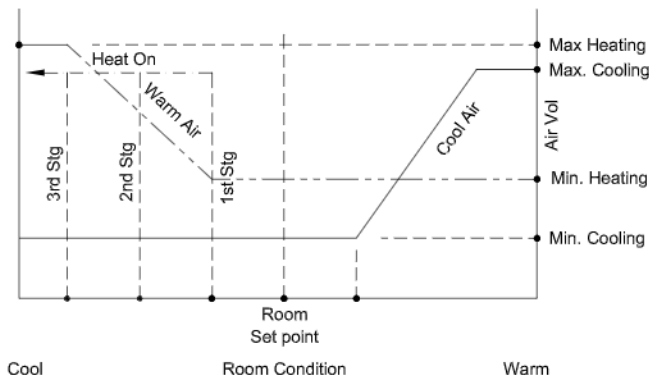

**Sequence of Operation -- Heat/cool changeover OR cooling  
With up to 3 stage binary reheat - Pressure Independent**

On power up the damper will calibrate closed for 2 minutes.

\*\*If no SAT sensor is present, the controller assumes Cool supply air at all times\*\*

**Cool supply air:** On an increase in space temperature the controller regulates the actuator to open the VAV damper and increase the flow of cool air. On an increase of space temperature greater than the cooling proportional band, the airflow is maintained at its pre-selected maximum setting.

On a decrease in space temperature the controller regulates the actuator to close the VAV damper and reduce the flow of cool air. If the space temperature decreases to less than the cooling proportional band, the airflow is maintained at the pre-selected minimum setting.

**Warm supply air:** On a decrease in space temperature the controller regulates the actuator to open the VAV damper and increase the flow of warm air. On a decrease of space temperature greater than the heating proportional band, the airflow is maintained at its pre-selected maximum setting.

On an increase in space temperature the controller regulates the actuator to close the VAV damper and reduce the flow of warm air. If the space temperature increases above the heating proportional band, the airflow is maintained at the pre-selected minimum setting.

**Reheat Operation:** On a decrease in space temperature into the heating proportional band, the 1st stage binary 24VAC reheat output will energize. Upon further decreases, the 2nd then 3rd stages of reheat (if used) will energize.

**PROJECT:**

**ENGINEER:**

**CUSTOMER:**

**SUBMITTAL DATE:**

**SPEC. SYMBOL:**

**PRICE**<sup>®</sup>

*BE MB*

**SINGLE DUCT  
PIC DDC**

PRESSURE INDEPENDENT  
HEAT/COOL C/O OR COOLING  
WITH UP TO 3 STG BINARY REHEAT  
FIELD WIRED

249532

2017/06/23

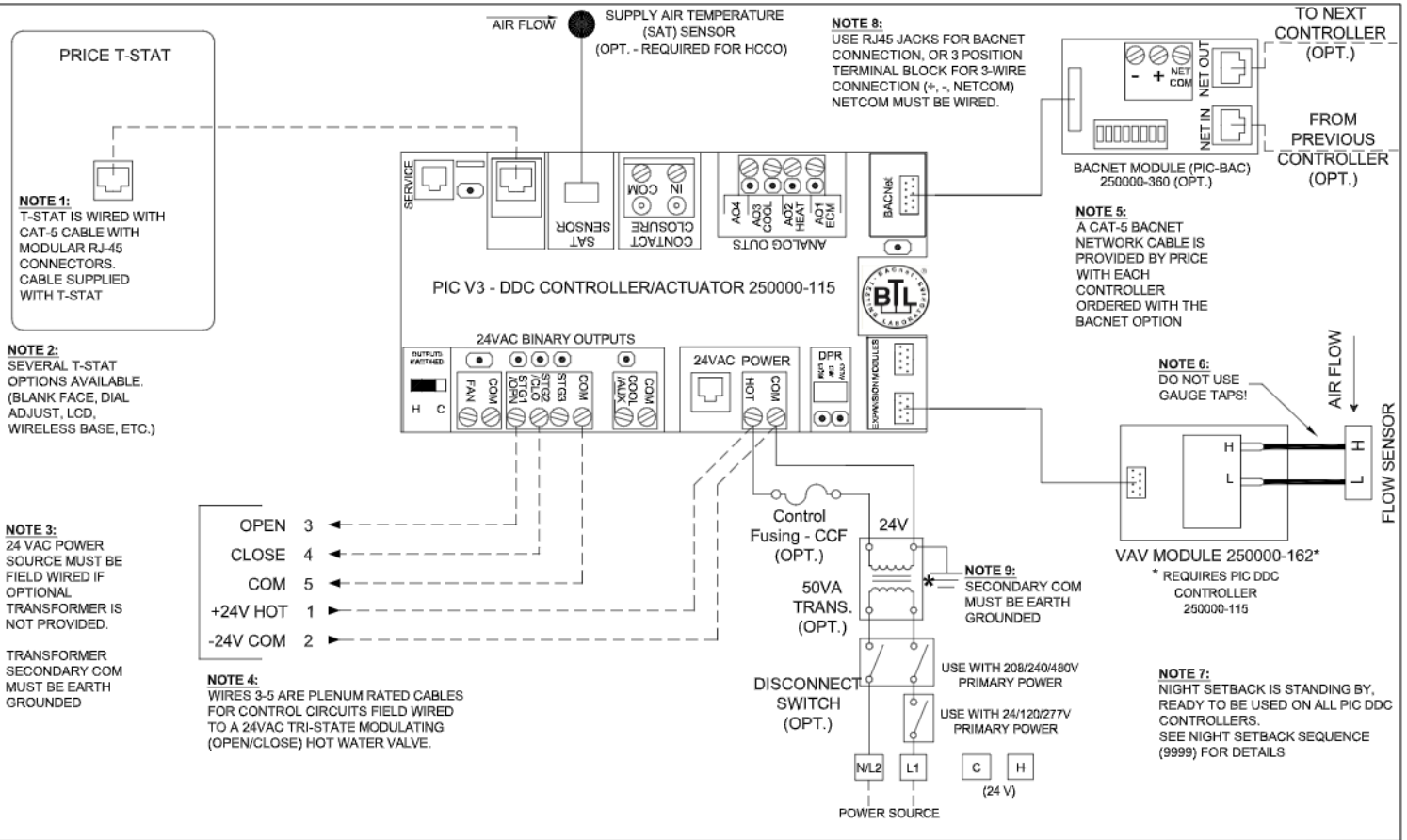

**Sequence of Operation -- Heat/cool changeover OR cooling With Tri-State modulating HW reheat - Pressure Independent**  
 On power up the damper will calibrate closed for 2 minutes.  
 \*\*If no SAT sensor is present, the controller assumes Cool supply air at all times\*\*

**Cool supply air:** On an increase in space temperature the controller regulates the actuator to open the VAV damper and increase the flow of cool air. On an increase of space temperature greater than the cooling proportional band, the airflow is maintained at its pre-selected maximum setting.  
 On a decrease in space temperature the controller regulates the actuator to close the VAV damper and reduce the flow of cool air. If the space temperature decreases to less than the cooling proportional band, the airflow is maintained at the pre-selected minimum setting.  
**Warm supply air:** On a decrease in space temperature the controller regulates the actuator to open the VAV damper and increase the flow of warm air. On a decrease of space temperature greater than the heating proportional band, the airflow is maintained at its pre-selected maximum setting.  
 On an increase in space temperature the controller regulates the actuator to close the VAV damper and reduce the flow of warm air. If the space temperature increases above the heating proportional band, the airflow is maintained at the pre-selected minimum setting.  
**Reheat Operation:** On a decrease in space temperature, the heating valve is modulated to increase heat proportionally to the room demand.

<b>PROJECT:</b>		
<b>ENGINEER:</b>		
<b>CUSTOMER:</b>		
<b>SUBMITTAL DATE:</b>	<b>SPEC. SYMBOL:</b>	

BE MB

**SINGLE DUCT  
PIC DDC**

PRESSURE INDEPENDENT  
HEAT/COOL C/O OR COOLING  
WITH TRI-STATE MODULATING  
HOT WATER REHEAT, FIELD WIRED



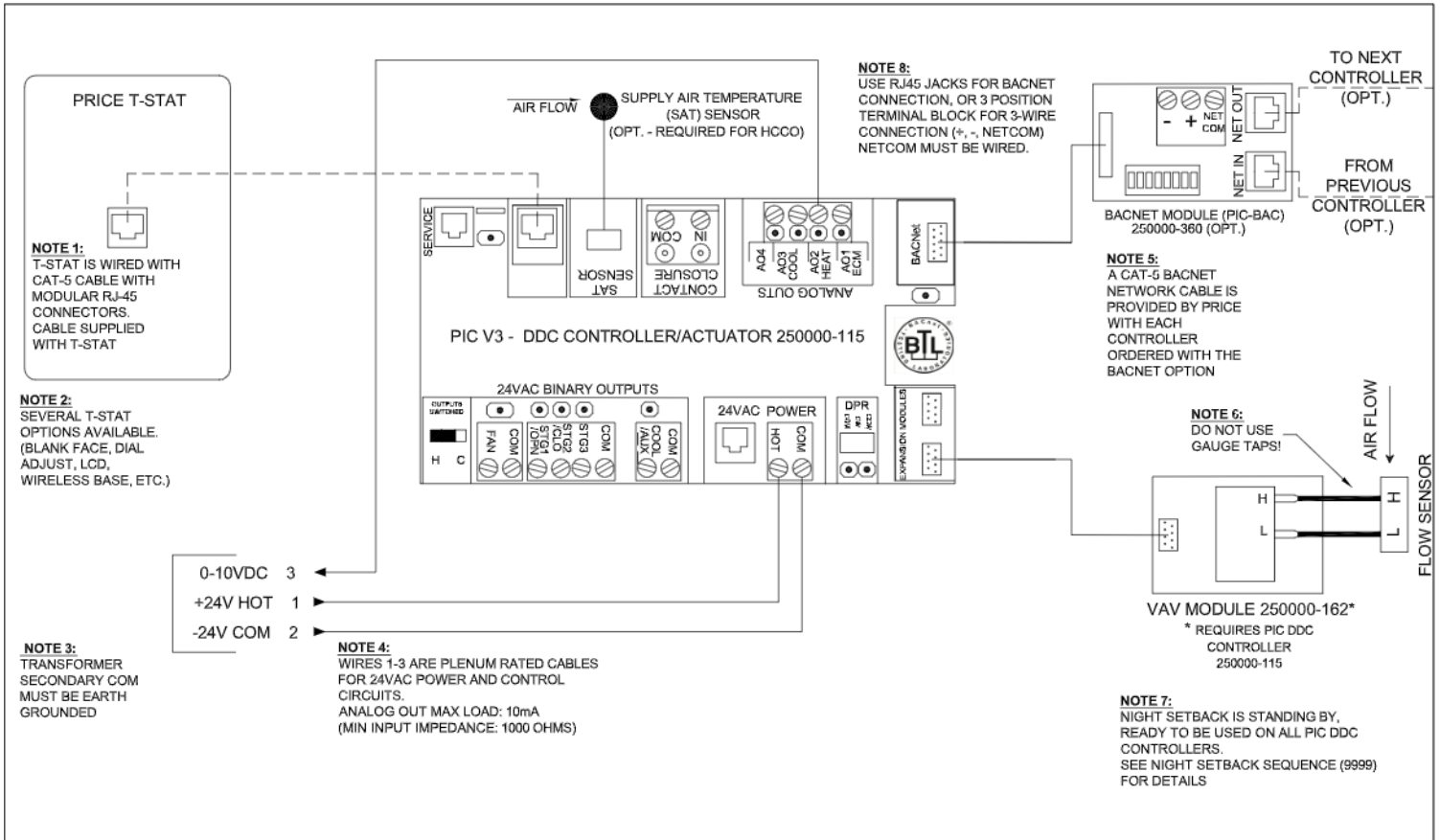

**Calibration note:** Suitable min and max heating flows must be selected in order to maintain flow through energized electric coils of at least 200 fpm and at least 70 cfm/kW throughout the entire operating range.

**LEGEND**

- FACTORY FLOW SENSOR TUBING
- FACTORY ELECTRICAL WIRING
- FIELD ELECTRICAL WIRING

**CONTROL GRAPH**

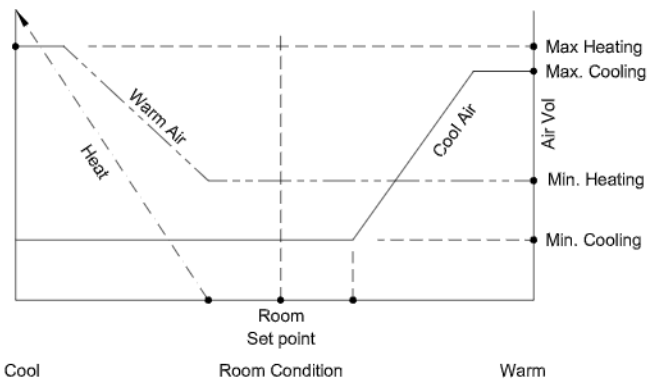

**Sequence of Operation -- Heat/cool changeover OR cooling  
With Analog modulating reheat - Pressure Independent**

On power up the damper will calibrate closed for 2 minutes.

\*\*If no SAT sensor is present, the controller assumes Cool supply air at all times\*\*

**Cool supply air:** On an increase in space temperature the controller regulates the actuator to open the VAV damper and increase the flow of cool air. On an increase of space temperature greater than the cooling proportional band, the airflow is maintained at its pre-selected maximum setting.

On a decrease in space temperature the controller regulates the actuator to close the VAV damper and reduce the flow of cool air. If the space temperature decreases to less than the cooling proportional band, the airflow is maintained at the pre-selected minimum setting.

**Warm supply air:** On a decrease in space temperature the controller regulates the actuator to open the VAV damper and increase the flow of warm air. On a decrease of space temperature greater than the heating proportional band, the airflow is maintained at its pre-selected maximum setting.

On an increase in space temperature the controller regulates the actuator to close the VAV damper and reduce the flow of warm air. If the space temperature increases above the heating proportional band, the airflow is maintained at the pre-selected minimum setting.

**Reheat Operation:** On a decrease in space temperature, the controller modulates the 0-10VDC output to increase heat proportionally to the room demand.

**PROJECT:**

**ENGINEER:**

**CUSTOMER:**

**SUBMITTAL DATE:**

**SPEC. SYMBOL:**

*BE MB*

249534

2017/06/23

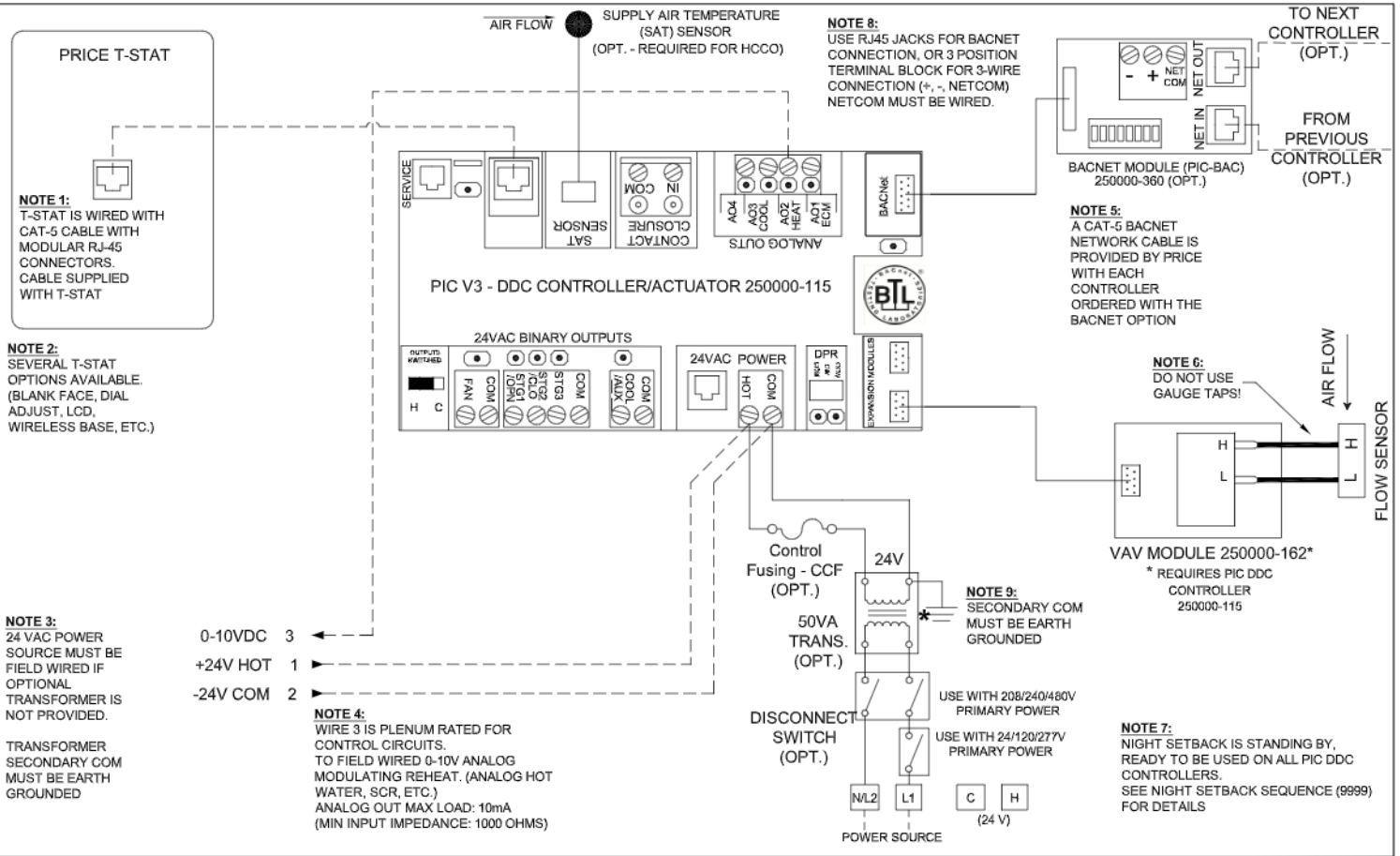

**Calibration note:** Suitable min and max heating flows must be selected in order to maintain flow through energized electric coils of at least 200 fpm and at least 70 cfm/kW throughout the entire operating range.

**LEGEND**

- FACTORY FLOW SENSOR TUBING
- FACTORY ELECTRICAL WIRING
- FIELD ELECTRICAL WIRING

**CONTROL GRAPH**

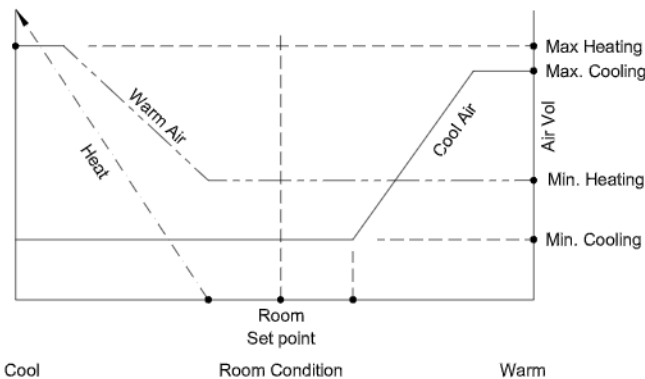

**Sequence of Operation -- Heat/cool changeover OR cooling  
With Analog modulating reheat - Pressure Independent**

On power up the damper will calibrate closed for 2 minutes.  
\*\*If no SAT sensor is present, the controller assumes Cool supply air at all times\*\*

**Cool supply air:** On an increase in space temperature the controller regulates the actuator to open the VAV damper and increase the flow of cool air. On an increase of space temperature greater than the cooling proportional band, the airflow is maintained at its pre-selected maximum setting.

On a decrease in space temperature the controller regulates the actuator to close the VAV damper and reduce the flow of cool air. If the space temperature decreases to less than the cooling proportional band, the airflow is maintained at the pre-selected minimum setting.

**Warm supply air:** On a decrease in space temperature the controller regulates the actuator to open the VAV damper and increase the flow of warm air. On a decrease of space temperature greater than the heating proportional band, the airflow is maintained at its pre-selected maximum setting.

On an increase in space temperature the controller regulates the actuator to close the VAV damper and reduce the flow of warm air. If the space temperature increases above the heating proportional band, the airflow is maintained at the pre-selected minimum setting.

**Reheat Operation:** On a decrease in space temperature, the controller modulates the 0-10VDC output to increase heat proportionally to the room demand.

**PROJECT:**

**ENGINEER:**

**CUSTOMER:**

**SUBMITTAL DATE:**

**SPEC. SYMBOL:**

**PRICE**<sup>®</sup>

*BE MB*

**SINGLE DUCT  
PIC DDC**

PRESSURE INDEPENDENT  
HEAT/COOL C/O OR COOLING  
WITH ANALOG HEAT  
FIELD WIRED

249535

2017/06/23

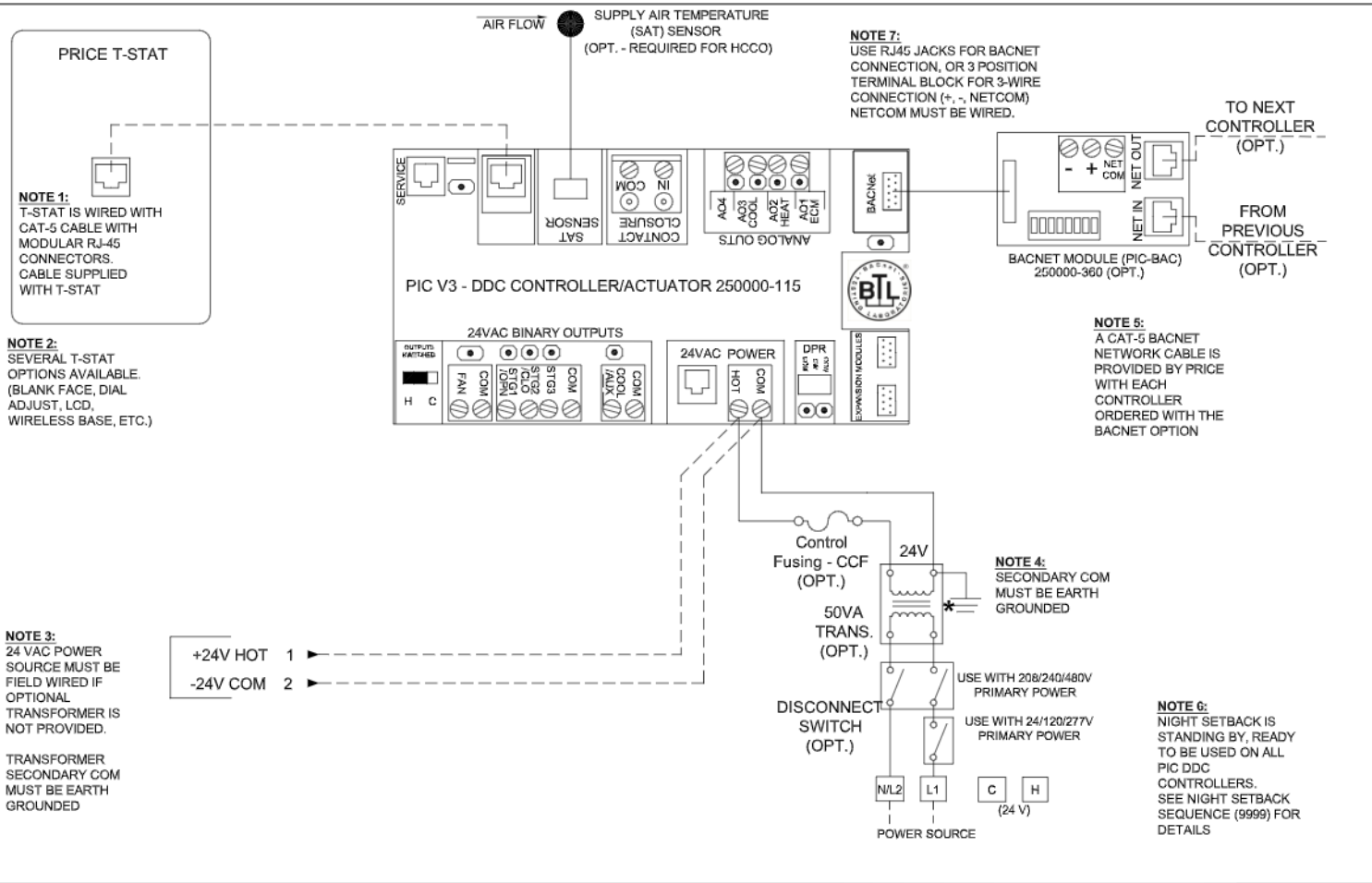

**LEGEND**

- FACTORY ELECTRICAL WIRING
- - - - - FIELD ELECTRICAL WIRING

**CONTROL GRAPH**

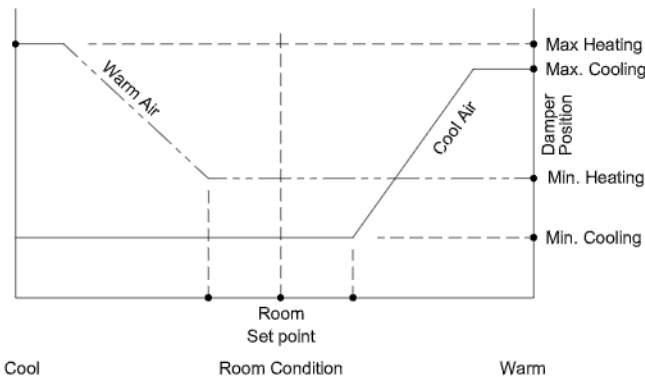

**Sequence of Operation -- Heat/cool changeover OR cooling only  
Pressure Dependent**

On power up the damper will calibrate closed for 2 minutes.  
\*\*If no SAT sensor is present, the controller assumes Cool supply air at all times\*\*

**Cool supply air:** On an increase in space temperature the controller regulates the actuator to open the air damper and increase the flow of cool air. On an increase of space temperature greater than the cooling proportional band, the damper position (%) is maintained at its pre-selected maximum setting.

On a decrease in space temperature the controller regulates the actuator to close the air damper and reduce the flow of cool air. If the space temperature decreases to less than the cooling proportional band, the damper position (%) is maintained at the pre-selected minimum setting.

**Warm supply air:** On a decrease in space temperature the controller regulates the actuator to open the air damper and increase the flow of warm air. On a decrease of space temperature greater than the heating proportional band, the damper position (%) is maintained at its pre-selected maximum setting.

On an increase in space temperature the controller regulates the actuator to close the air damper and reduce the flow of warm air. If the space temperature increases above the heating proportional band, the damper position (%) is maintained at the pre-selected minimum setting.

**PROJECT:**

**ENGINEER:**

**CUSTOMER:**

**SUBMITTAL DATE:**

**SPEC. SYMBOL:**

**PRICE**<sup>®</sup>

**SINGLE DUCT  
PIC DDC**

PRESSURE DEPENDENT  
HEAT/COOL CHANGEOVER  
OR COOLING ONLY  
NO LOCAL REHEAT CONTROL

249536

2017/06/23

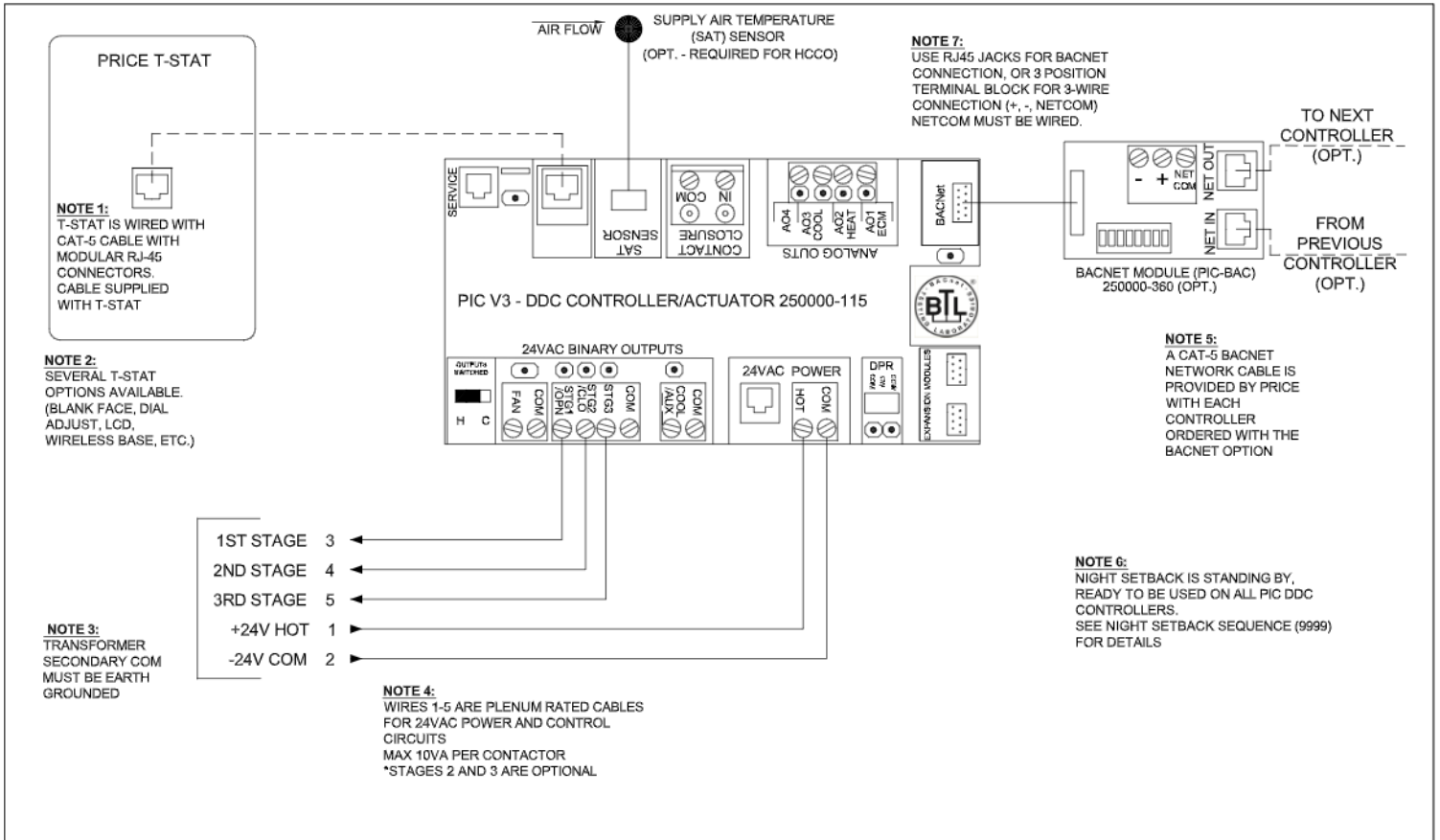

**Calibration note:** Suitable min and max heating flows must be selected in order to maintain flow through energized electric coils of at least 200 fpm and at least 70 cfm/kW throughout the entire operating range.

**LEGEND**

- FACTORY ELECTRICAL WIRING
- - - - - FIELD ELECTRICAL WIRING

**CONTROL GRAPH**

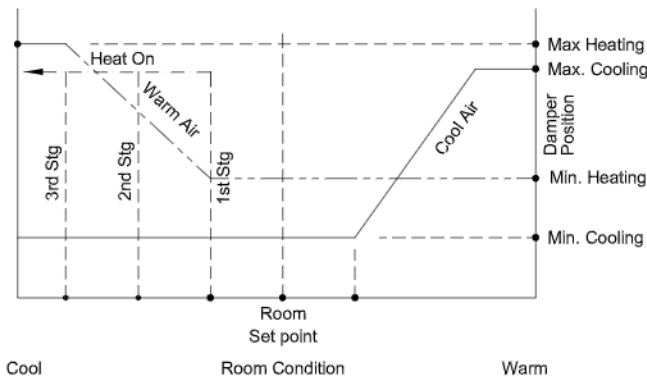

**Sequence of Operation -- Heat/cool changeover OR cooling  
With up to 3 stage binary reheat - Pressure Dependent**

On power up the damper will calibrate closed for 2 minutes.

\*\*If no SAT sensor is present, the controller assumes Cool supply air at all times\*\*

**Cool supply air:** On an increase in space temperature the controller regulates the actuator to open the air damper and increase the flow of cool air. On an increase of space temperature greater than the cooling proportional band, the damper position (%) is maintained at its pre-selected maximum setting.

On a decrease in space temperature the controller regulates the actuator to close the air damper and reduce the flow of cool air. If the space temperature decreases to less than the cooling proportional band, the damper position (%) is maintained at the pre-selected minimum setting.

**Warm supply air:** On a decrease in space temperature the controller regulates the actuator to open the air damper and increase the flow of warm air. On a decrease of space temperature greater than the heating proportional band, the damper position (%) is maintained at its pre-selected maximum setting.

On an increase in space temperature the controller regulates the actuator to close the air damper and reduce the flow of warm air. If the space temperature increases above the heating proportional band, the damper position (%) is maintained at the pre-selected minimum setting.

**Reheat Operation:** On a decrease in space temperature into the heating proportional band, the 1st stage binary 24VAC reheat output will energize. Upon further decreases, the 2nd then 3rd stages of reheat (if used) will energize.

**PROJECT:**

**ENGINEER:**

**CUSTOMER:**

**SUBMITTAL DATE:**

**SPEC. SYMBOL:**

**PRICE**<sup>®</sup>

**SINGLE DUCT  
PIC DDC**

PRESSURE DEPENDENT  
HEAT/COOL C/O OR COOLING  
WITH UP TO 3 STG BINARY REHEAT  
FACTORY WIRED

249537

2017/06/23



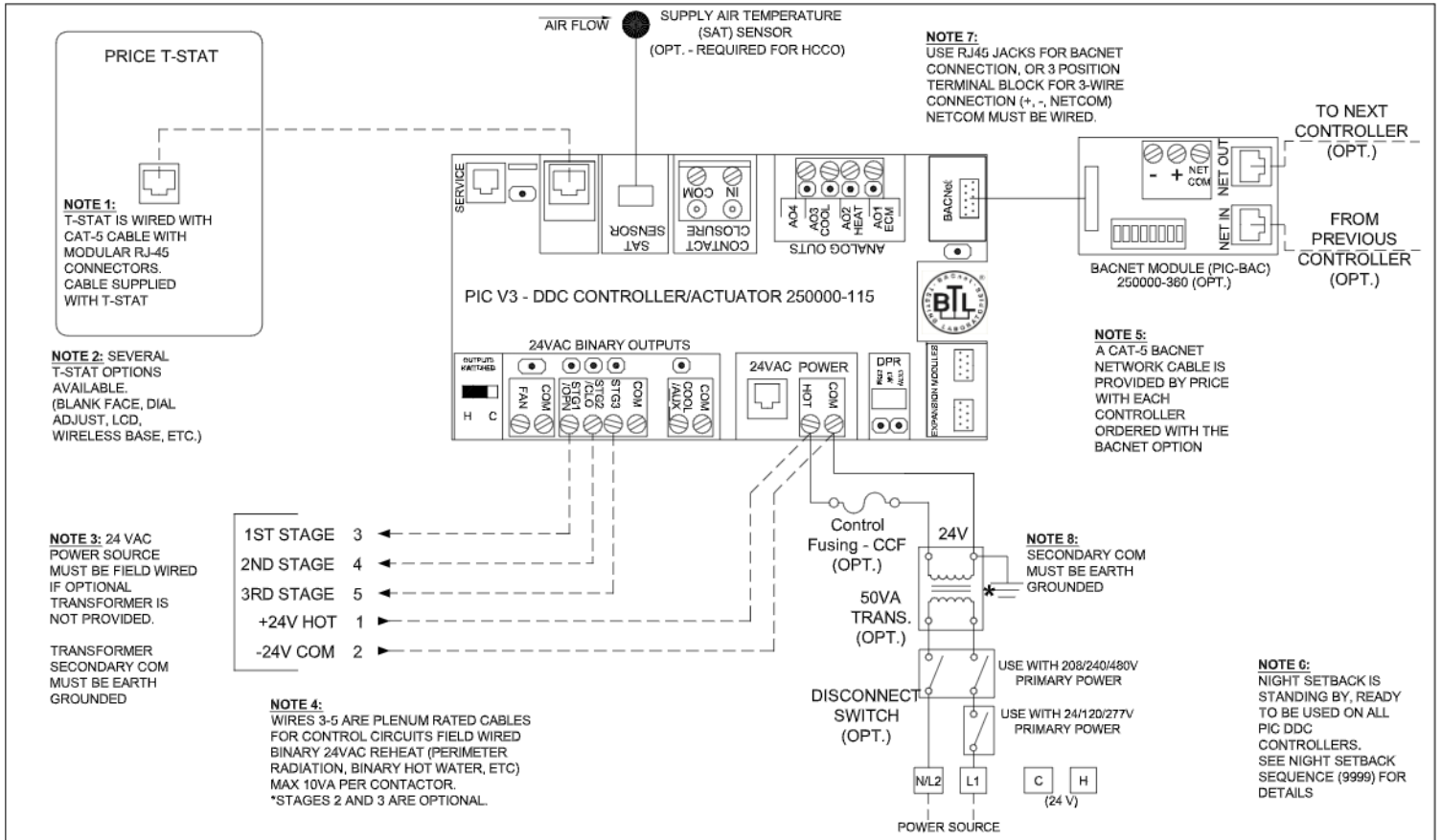

**Calibration note:** Suitable min and max heating flows must be selected in order to maintain flow through energized electric coils of at least 200 fpm and at least 70 cfm/kW throughout the entire operating range.

### Sequence of Operation -- Heat/cool changeover OR cooling With up to 3 stage binary reheat - Pressure Dependent

On power up the damper will calibrate closed for 2 minutes.

\*\*If no SAT sensor is present, the controller assumes Cool supply air at all times\*\*

**Cool supply air:** On an increase in space temperature the controller regulates the actuator to open the air damper and increase the flow of cool air. On an increase of space temperature greater than the cooling proportional band, the damper position (%) is maintained at its pre-selected maximum setting.

On a decrease in space temperature the controller regulates the actuator to close the air damper and reduce the flow of cool air. If the space temperature decreases to less than the cooling proportional band, the damper position (%) is maintained at the pre-selected minimum setting.

**Warm supply air:** On a decrease in space temperature the controller regulates the actuator to open the air damper and increase the flow of warm air. On a decrease of space temperature greater than the heating proportional band, the damper position (%) is maintained at its pre-selected maximum setting.

On an increase in space temperature the controller regulates the actuator to close the air damper and reduce the flow of warm air. If the space temperature increases above the heating proportional band, the damper position (%) is maintained at the pre-selected minimum setting.

**Reheat Operation:** On a decrease in space temperature into the heating proportional band, the 1st stage binary 24VAC reheat output will energize. Upon further decreases, the 2nd then 3rd stages of reheat (if used) will energize.

**PROJECT:**

**ENGINEER:**

**CUSTOMER:**

**SUBMITTAL DATE:**

**SPEC. SYMBOL:**

**PRICE®**

**SINGLE DUCT  
PIC DDC**

PRESSURE DEPENDENT  
HEAT/COOL C/O OR COOLING  
WITH UP TO 3 STG BINARY REHEAT  
FIELD WIRED

249538

2017/06/23

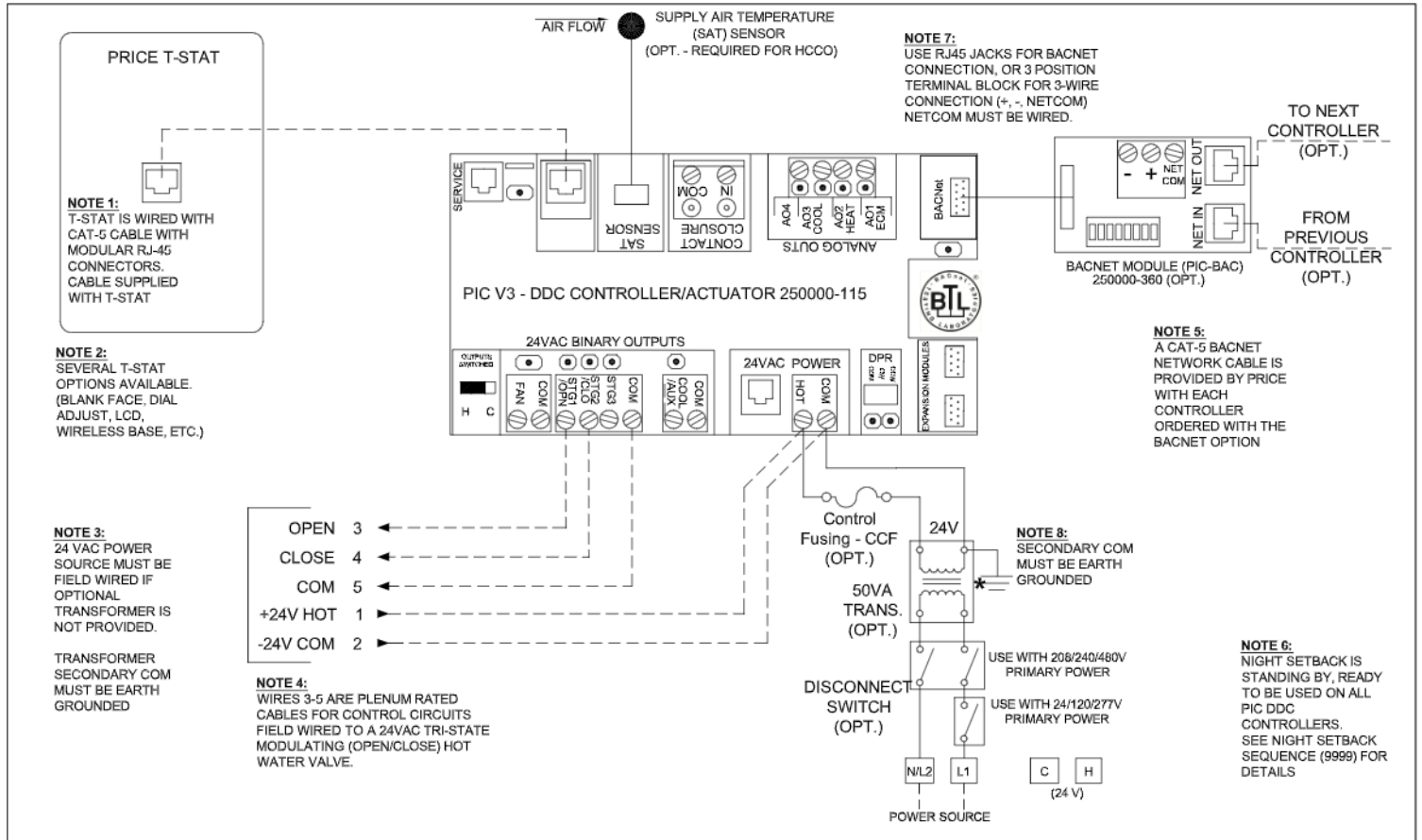

**CONTROL GRAPH**

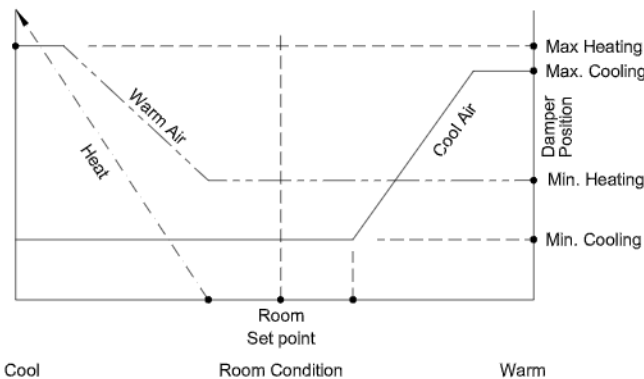

**Sequence of Operation -- Heat/cool changeover OR cooling With Tri-State modulating HW reheat - Pressure Dependent**

On power up the damper will calibrate closed for 2 minutes.

\*\*If no SAT sensor is present, the controller assumes Cool supply air at all times\*\*

**Cool supply air:** On an increase in space temperature the controller regulates the actuator to open the air damper and increase the flow of cool air. On an increase of space temperature greater than the cooling proportional band, the damper position (%) is maintained at its pre-selected maximum setting.

On a decrease in space temperature the controller regulates the actuator to close the air damper and reduce the flow of cool air. If the space temperature decreases to less than the cooling proportional band, the damper position (%) is maintained at the pre-selected minimum setting.

**Warm supply air:** On a decrease in space temperature the controller regulates the actuator to open the air damper and increase the flow of warm air. On a decrease of space temperature greater than the heating proportional band, the damper position (%) is maintained at its pre-selected maximum setting.

On an increase in space temperature the controller regulates the actuator to close the air damper and reduce the flow of warm air. If the space temperature increases above the heating proportional band, the damper position (%) is maintained at the pre-selected minimum setting.

**Reheat Operation:** On a decrease in space temperature, the heating valve is modulated to increase heat proportionally to the room demand.

**PROJECT:**

**ENGINEER:**

**CUSTOMER:**

**SUBMITTAL DATE:**

**SPEC. SYMBOL:**

**PRICE**<sup>®</sup>

*BE MB*

**SINGLE DUCT  
PIC DDC**

PRESSURE DEPENDENT  
HEAT/COOL C/O OR COOLING  
WITH TRI-STATE MODULATING  
HOT WATER REHEAT, FIELD WIRED

249539

2017/06/23

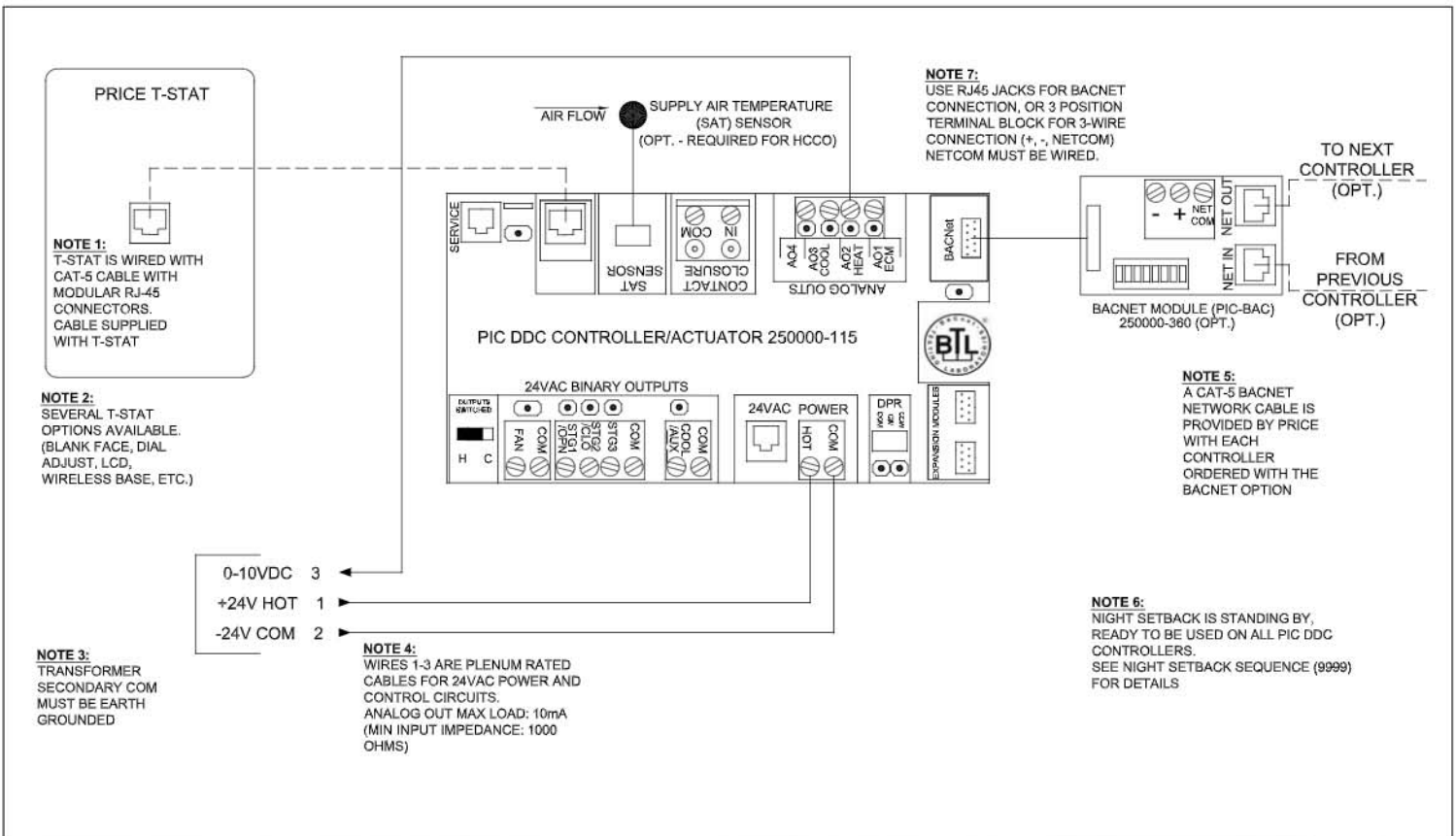

**Calibration note:** Suitable min and max heating flows must be selected in order to maintain flow through energized electric coils of at least 200 fpm and at least 70 cfm/kW throughout the entire operating range.

**LEGEND**

- FACTORY ELECTRICAL WIRING
- - - - - FIELD ELECTRICAL WIRING

**CONTROL GRAPH**

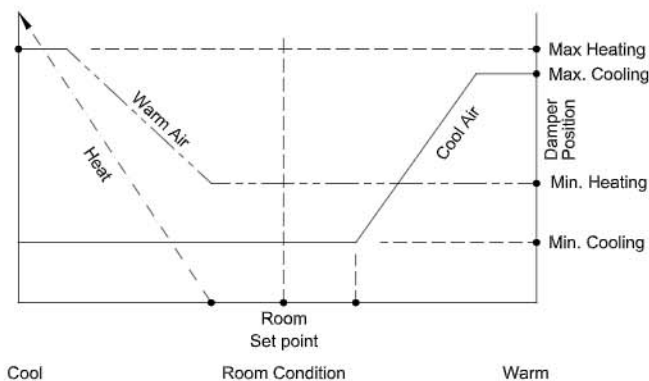

**Sequence of Operation -- Heat/cool changeover OR cooling With Analog modulating reheat - Pressure Dependent**

On power up the damper will calibrate closed for 2 minutes.  
\*\*If no SAT sensor is present, the controller assumes Cool supply air at all times\*\*

**Cool supply air:** On an increase in space temperature the controller regulates the actuator to open the air damper and increase the flow of cool air. On an increase of space temperature greater than the cooling proportional band, the damper position (%) is maintained at its pre-selected maximum setting.

On a decrease in space temperature the controller regulates the actuator to close the air damper and reduce the flow of cool air. If the space temperature decreases to less than the cooling proportional band, the damper position (%) is maintained at the pre-selected minimum setting.

**Warm supply air:** On a decrease in space temperature the controller regulates the actuator to open the air damper and increase the flow of warm air. On a decrease of space temperature greater than the heating proportional band, the damper position (%) is maintained at its pre-selected maximum setting.

On an increase in space temperature the controller regulates the actuator to close the air damper and reduce the flow of warm air. If the space temperature increases above the heating proportional band, the damper position (%) is maintained at the pre-selected minimum setting.

**Reheat Operation:** On a decrease in space temperature, the controller modulates the 0-10VDC output to increase heat proportionally to the room demand.

**PROJECT:**

**ENGINEER:**

**CUSTOMER:**

**SUBMITTAL DATE:**

**SPEC. SYMBOL:**

*BE MB*

249540

2017/06/23



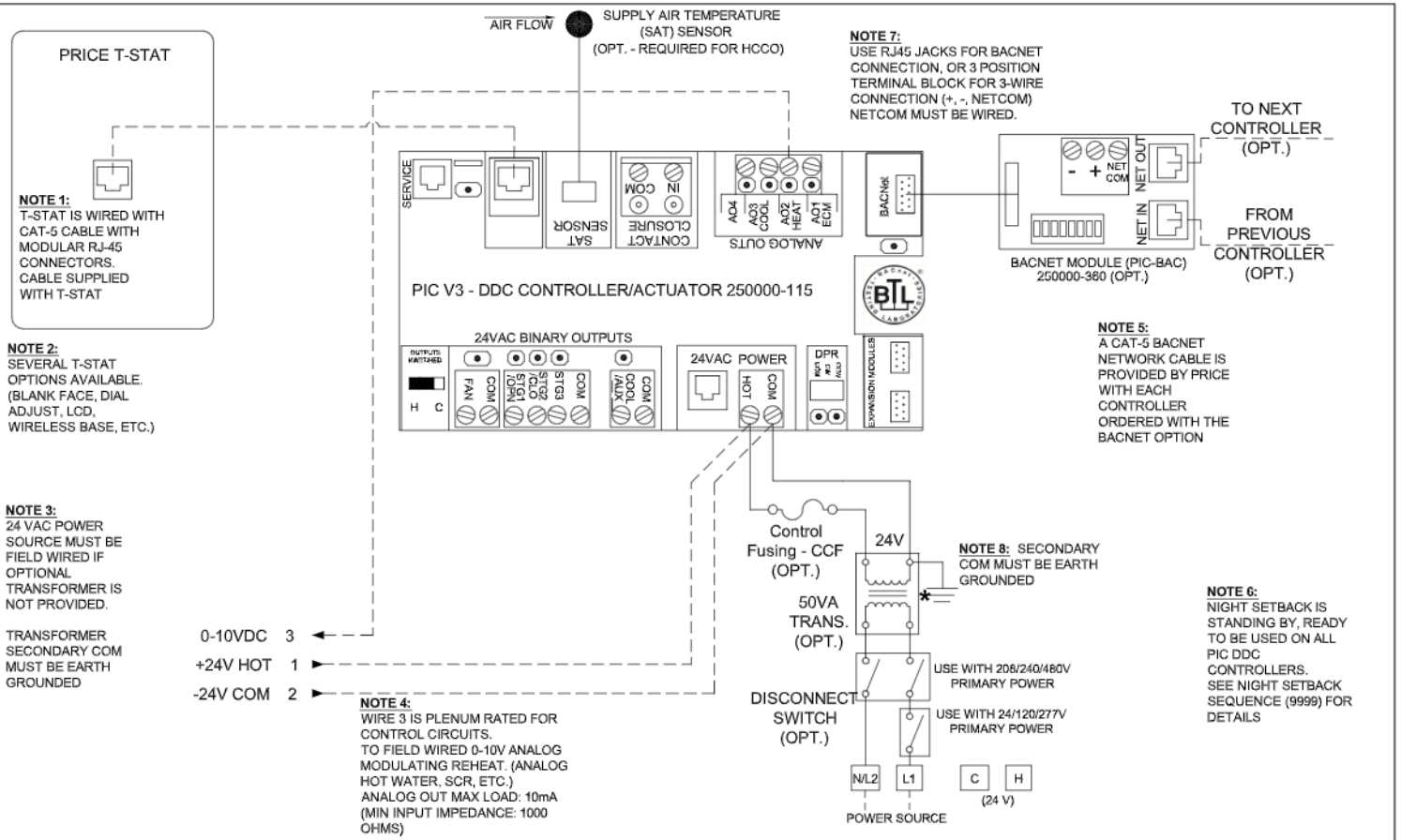

**Calibration note:** Suitable min and max heating flows must be selected in order to maintain flow through energized electric coils of at least 200 fpm and at least 70 cfm/kW throughout the entire operating range.

**Sequence of Operation -- Heat/cool changeover OR cooling With Analog modulating reheat - Pressure Dependent**

On power up the damper will calibrate closed for 2 minutes.

\*\*If no SAT sensor is present, the controller assumes Cool supply air at all times\*\*

**Cool supply air:** On an increase in space temperature the controller regulates the actuator to open the air damper and increase the flow of cool air. On an increase of space temperature greater than the cooling proportional band, the damper position (%) is maintained at its pre-selected maximum setting.

On a decrease in space temperature the controller regulates the actuator to close the air damper and reduce the flow of cool air. If the space temperature decreases to less than the cooling proportional band, the damper position (%) is maintained at the pre-selected minimum setting.

**Warm supply air:** On a decrease in space temperature the controller regulates the actuator to open the air damper and increase the flow of warm air. On a decrease of space temperature greater than the heating proportional band, the damper position (%) is maintained at its pre-selected maximum setting.

On an increase in space temperature the controller regulates the actuator to close the air damper and reduce the flow of warm air. If the space temperature increases above the heating proportional band, the damper position (%) is maintained at the pre-selected minimum setting.

**Reheat Operation:** On a decrease in space temperature, the controller modulates the 0-10VDC output to increase heat proportionally to the room demand.

**LEGEND**

- FACTORY ELECTRICAL WIRING
- - - - - FIELD ELECTRICAL WIRING

**CONTROL GRAPH**

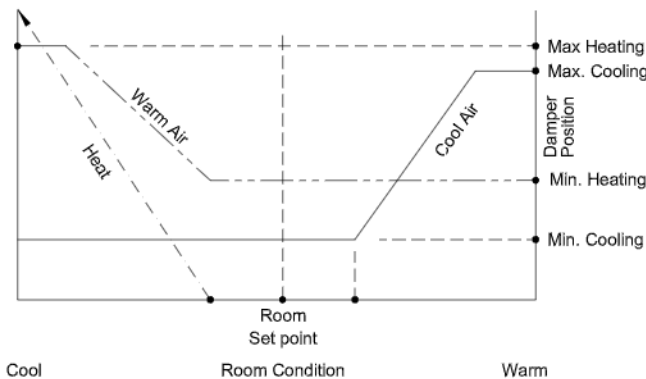

**PROJECT:**

**ENGINEER:**

**CUSTOMER:**

**SUBMITTAL DATE:**

**SPEC. SYMBOL:**

<b>PRICE</b> <sup>®</sup>	
<i>BE MB</i>	<b>SINGLE DUCT PIC DDC</b>
249541	PRESSURE DEPENDENT HEAT/COOL C/O OR COOLING WITH ANALOG HEAT FIELD WIRED
2017/06/23	



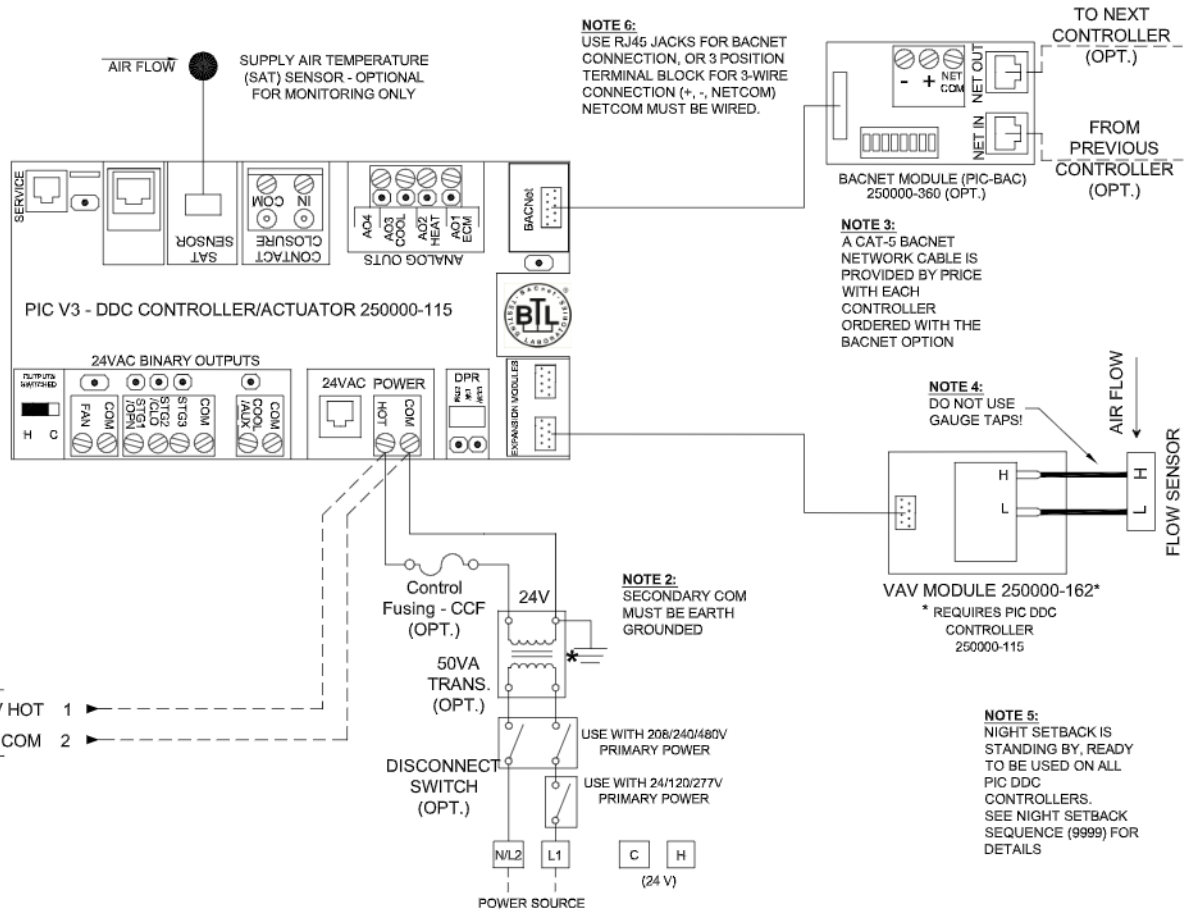

**LEGEND**

- FACTORY FLOW SENSOR TUBING
- FACTORY ELECTRICAL WIRING
- FIELD ELECTRICAL WIRING

**CONTROL GRAPH**

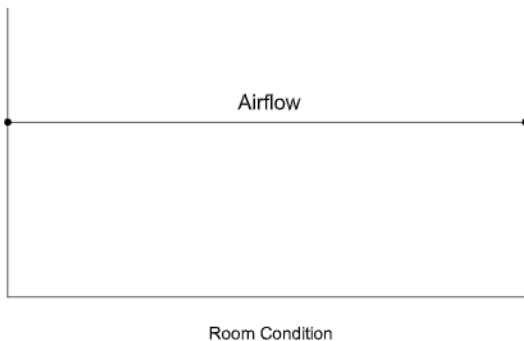

**Sequence of Operation -- Constant Volume, Pressure Independent.**  
On power up the damper will calibrate closed for 2 minutes.

**The PIC Controller** shall maintain a constant airflow.

On an increase in static pressure, the controller regulates the actuator to close the VAV damper and reduce the airflow.

On a decrease in static pressure, the controller regulates the actuator to open the VAV damper and increase the airflow.

**PROJECT:**

**ENGINEER:**

**CUSTOMER:**

**SUBMITTAL DATE:**

**SPEC. SYMBOL:**

<b>PRICE</b> <sup>®</sup>	
<i>BE MB</i>	<b>SDE8000/SDEQ8000 SINGLE DUCT EXHAUST PIC DDC PRESSURE INDEPENDENT CONSTANT VOLUME</b>
253402	
2017/06/26	

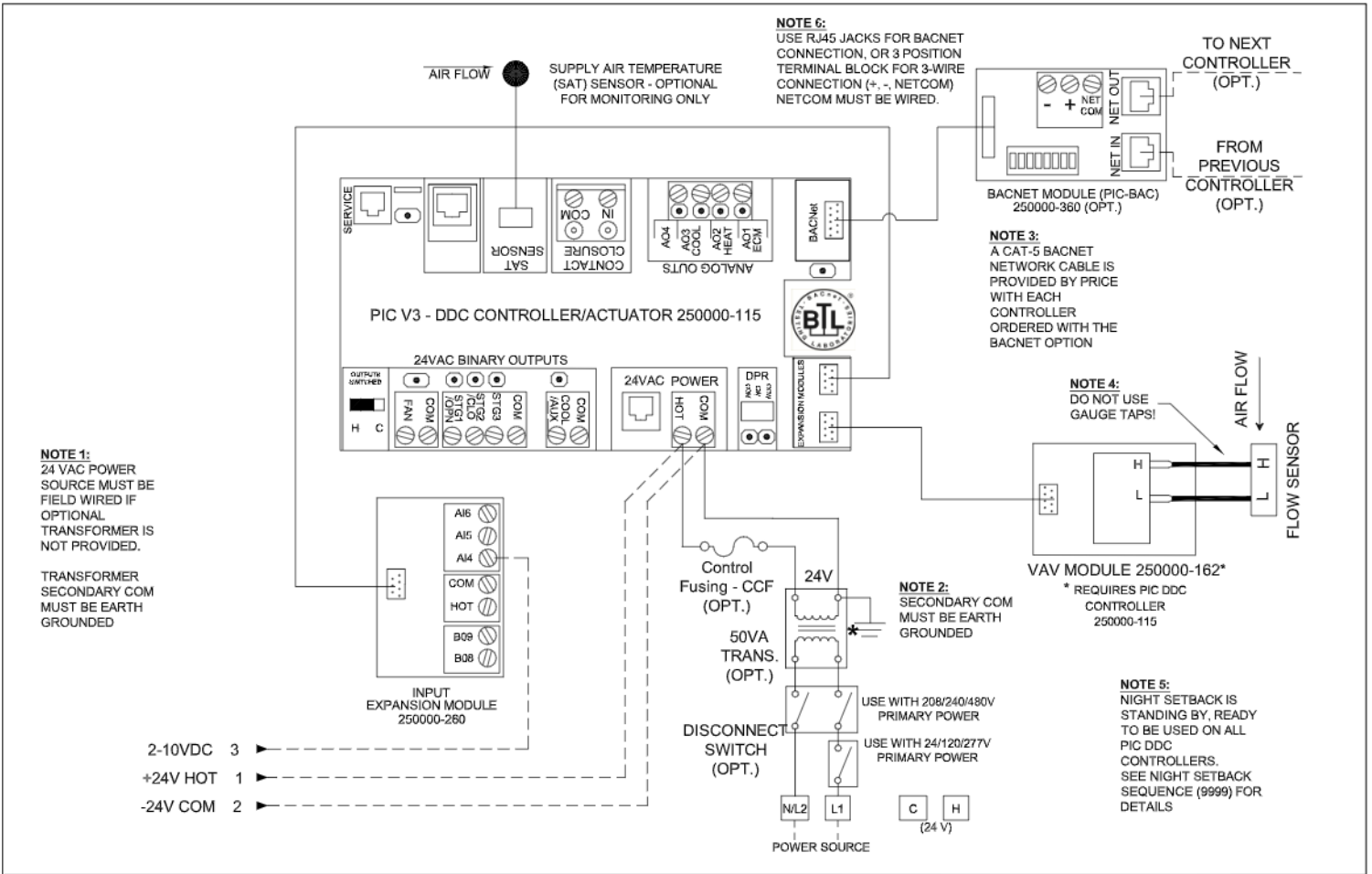

**LEGEND**

- FACTORY FLOW SENSOR TUBING
- FACTORY ELECTRICAL WIRING
- FIELD ELECTRICAL WIRING

**CONTROL GRAPH**

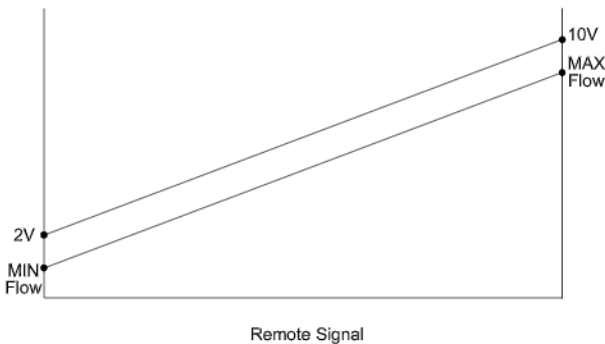

**Sequence of Operation -- Constant Volume from remote 2-10V setpoint, Pressure Independent.**

On power up the damper will calibrate closed for 2 minutes.

**The PIC Controller** shall maintain a constant airflow. The airflow setpoint is determined from a scalable 2-10V input.

On an increase in static pressure, the controller regulates the actuator to close the VAV damper and reduce the airflow.

On a decrease in static pressure, the controller regulates the actuator to open the VAV damper and increase the airflow.

**Calibration note:** Suitable min and max heating flows must be selected in order to maintain flow through energized electric coils of at least 200 fpm and at least 70 cfm/kW throughout the entire operating range.

**PROJECT:**

**ENGINEER:**

**CUSTOMER:**

**SUBMITTAL DATE:**

**SPEC. SYMBOL:**



*BE MB*

**SDE8000/SDEQ8000  
SINGLE DUCT EXHAUST  
PIC DDC  
PRESSURE INDEPENDENT  
CONSTANT VOLUME  
REMOTE 2-10V SETPOINT**

253403

2017/06/23

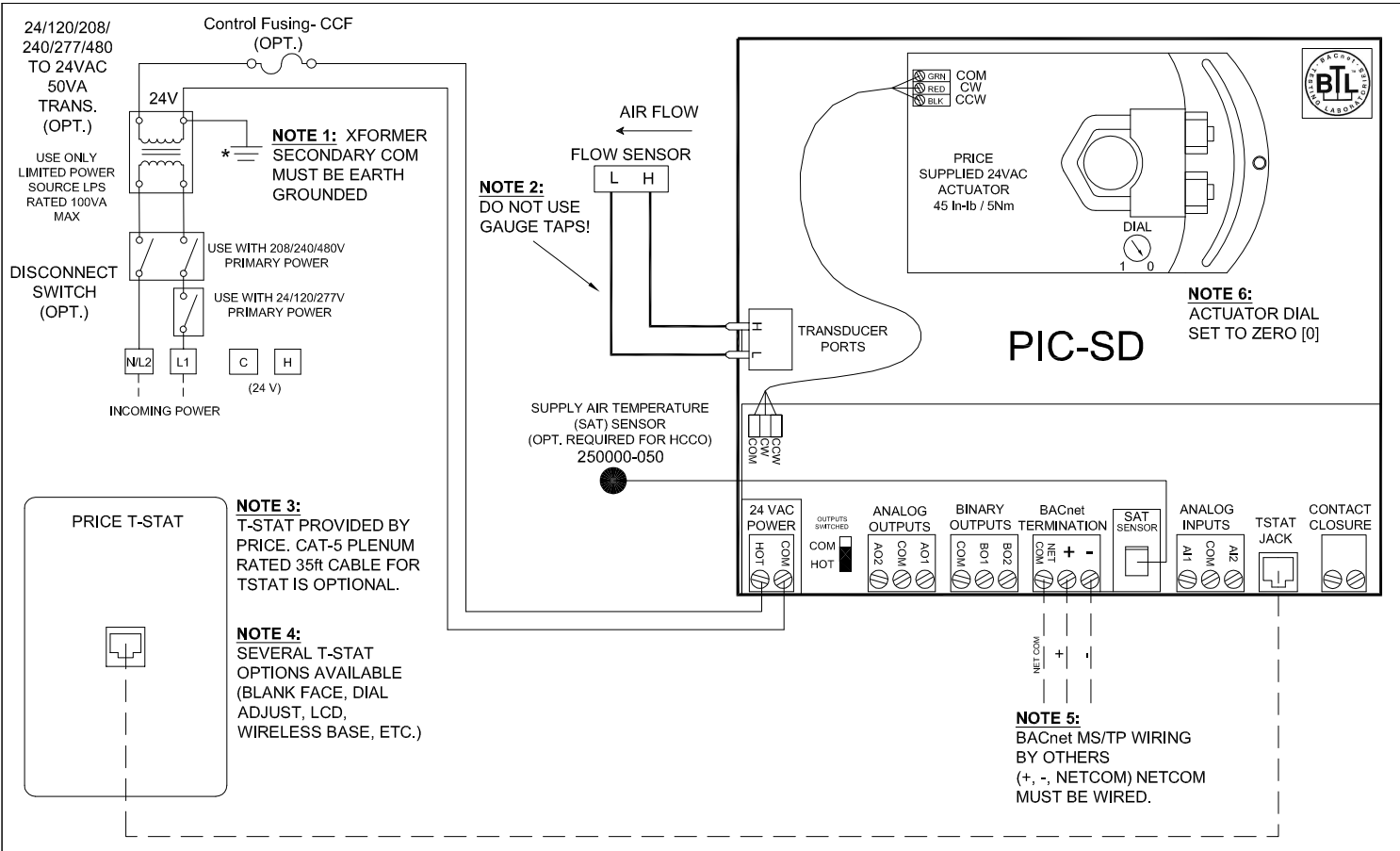

**LEGEND**

- FACTORY FLOW SENSOR TUBING
- FACTORY ELECTRICAL WIRING
- - - - -** FIELD ELECTRICAL WIRING

**CONTROL GRAPH**

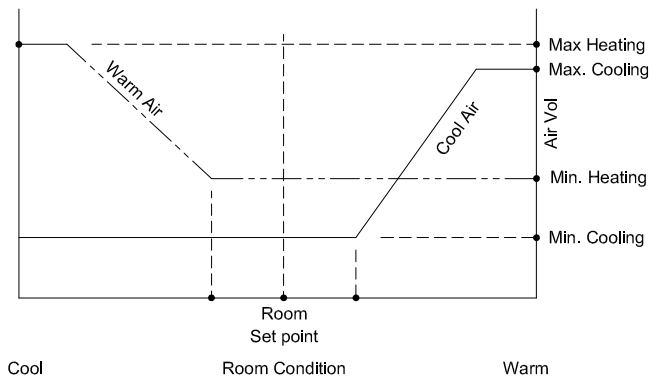

**Sequence of Operation (PIC-SD) -- Heat/cool changeover OR Cooling only, Pressure Independent**

On power up the damper will calibrate closed for 2 minutes.  
\*\*If no SAT sensor is present, the controller assumes Cool supply air at all times\*\*

**Cool supply air:** On an increase in space temperature the controller regulates the actuator to open the VAV damper and increase the flow of cool air. On an increase of space temperature greater than the cooling proportional band, the airflow is maintained at its pre-selected maximum setting.

On a decrease in space temperature the controller regulates the actuator to close the VAV damper and reduce the flow of cool air. If the space temperature decreases to less than the cooling proportional band, the airflow is maintained at the pre-selected minimum setting.

**Warm supply air:** On a decrease in space temperature the controller regulates the actuator to open the VAV damper and increase the flow of warm air. On a decrease of space temperature greater than the heating proportional band, the airflow is maintained at its pre-selected maximum setting.

On an increase in space temperature the controller regulates the actuator to close the VAV damper and reduce the flow of warm air. If the space temperature increases above the heating proportional band, the airflow is maintained at the pre-selected minimum setting.

**PROJECT:**

**ENGINEER:**

**CUSTOMER:**

**SUBMITTAL DATE:**

**SPEC. SYMBOL:**

**PRICE**<sup>®</sup>

*[Handwritten Signature]*

264666

2019/03/19

**SINGLE DUCT  
PIC-SD DDC**  
PRESSURE INDEPENDENT  
HEAT/COOL C/O OR COOLING ONLY  
NO LOCAL REHEAT CONTROL  
FACTORY WIRED

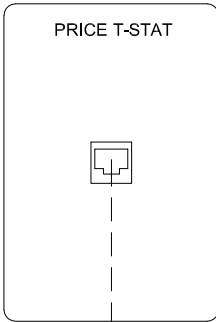

- NOTE 1:**  
T-STAT PROVIDED BY PRICE. CAT-5 PLENUM RATED 35ft CABLE FOR TSTAT IS OPTIONAL.
- NOTE 3:**  
SEVERAL T-STAT OPTIONS AVAILABLE (BLANK FACE, DIAL ADJUST, LCD, WIRELESS BASE, ETC.)
- NOTE 4:**  
XFORMER PROVIDED AS STANDARD AND INSTALLED WITH HEATER
- NOTE 5:**  
XFORMER SECONDARY COM MUST BE EARTH GROUNDED
- NOTE 6:** USE ONLY LIMITED POWER SOURCE LPS RATED 100VA MAX
- NOTE 7:**  
WIRES FOR BINARY HEAT ARE PLENUM RATED CABLES FOR 24VAC POWER AND CONTROL CIRCUITS - MAX 10VA PER BINARY OUTPUT  
\*STAGE 2 IS OPTIONAL

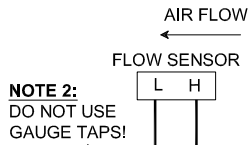

**NOTE 2:**  
DO NOT USE GAUGE TAPS!

SUPPLY AIR TEMPERATURE (SAT) SENSOR (OPT. REQUIRED FOR HCCO) 250000-050

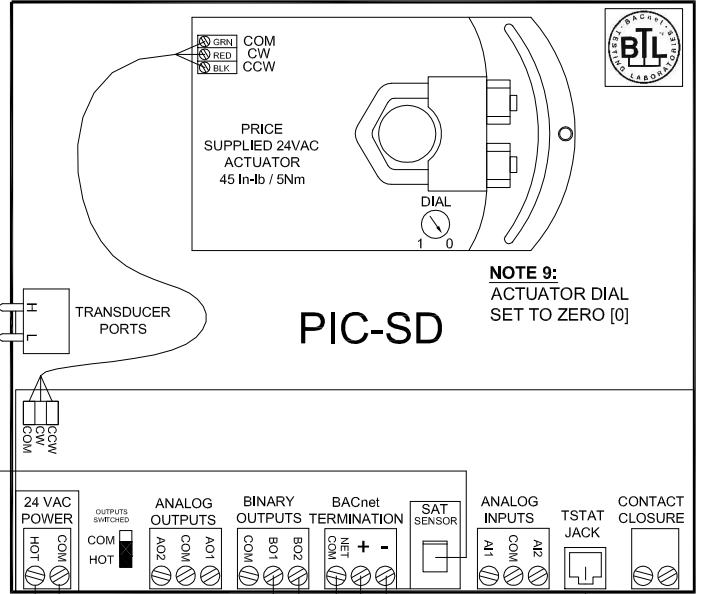

**NOTE 9:**  
ACTUATOR DIAL SET TO ZERO [0]

- +24V HOT 1
- 24V COM 2
- 1ST STAGE 3
- 2ND STAGE 4

**NOTE 8:**  
BACnet MS/TP WIRING BY OTHERS (+, -, NETCOM) NETCOM MUST BE WIRED.

**LEGEND**

- FACTORY FLOW SENSOR TUBING
- FACTORY ELECTRICAL WIRING
- FIELD ELECTRICAL WIRING

**Calibration note:** Suitable min and max heating flows must be selected in order to maintain flow through energized electric coils of at least 200 fpm and at least 70 cfm/kW throughout the entire operating range.

**CONTROL GRAPH**

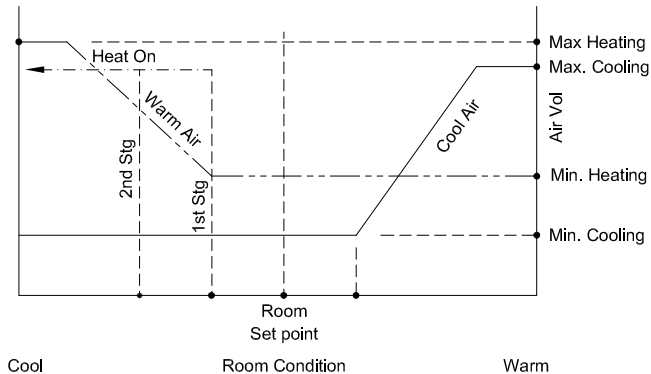

**Sequence of Operation (PIC-SD) -- Heat/cool changeover OR Cooling with up to 2 Stages of Binary Reheat - Pressure Independent**

On power up the damper will calibrate closed for 2 minutes.  
**\*\*If no SAT sensor is present, the controller assumes Cool supply air at all times\*\***

**Cool supply air:** On an increase in space temperature the controller regulates the actuator to open the VAV damper and increase the flow of cool air. On an increase of space temperature greater than the cooling proportional band, the airflow is maintained at its pre-selected maximum setting.  
 On a decrease in space temperature the controller regulates the actuator to close the VAV damper and reduce the flow of cool air. If the space temperature decreases to less than the cooling proportional band, the airflow is maintained at the pre-selected minimum setting.

**Warm supply air:** On a decrease in space temperature the controller regulates the actuator to open the VAV damper and increase the flow of warm air. On a decrease of space temperature greater than the heating proportional band, the airflow is maintained at its pre-selected maximum setting.  
 On an increase in space temperature the controller regulates the actuator to close the VAV damper and reduce the flow of warm air. If the space temperature increases above the heating proportional band, the airflow is maintained at the pre-selected minimum setting.

**Reheat Operation:** On a decrease in space temperature into the heating proportional band, the 1st stage binary 24VAC reheat output will energize. Upon further decreases, the 2nd stage of reheat will energize.

**PROJECT:**

**ENGINEER:**

**CUSTOMER:**

**SUBMITTAL DATE:**

**SPEC. SYMBOL:**

**SINGLE DUCT  
PIC-SD DDC**

PRESSURE INDEPENDENT  
HEAT/COOL C/O OR COOLING ONLY  
WITH UP TO 2 STG BINARY HEAT  
FACTORY WIRED

264667

2019/03/19



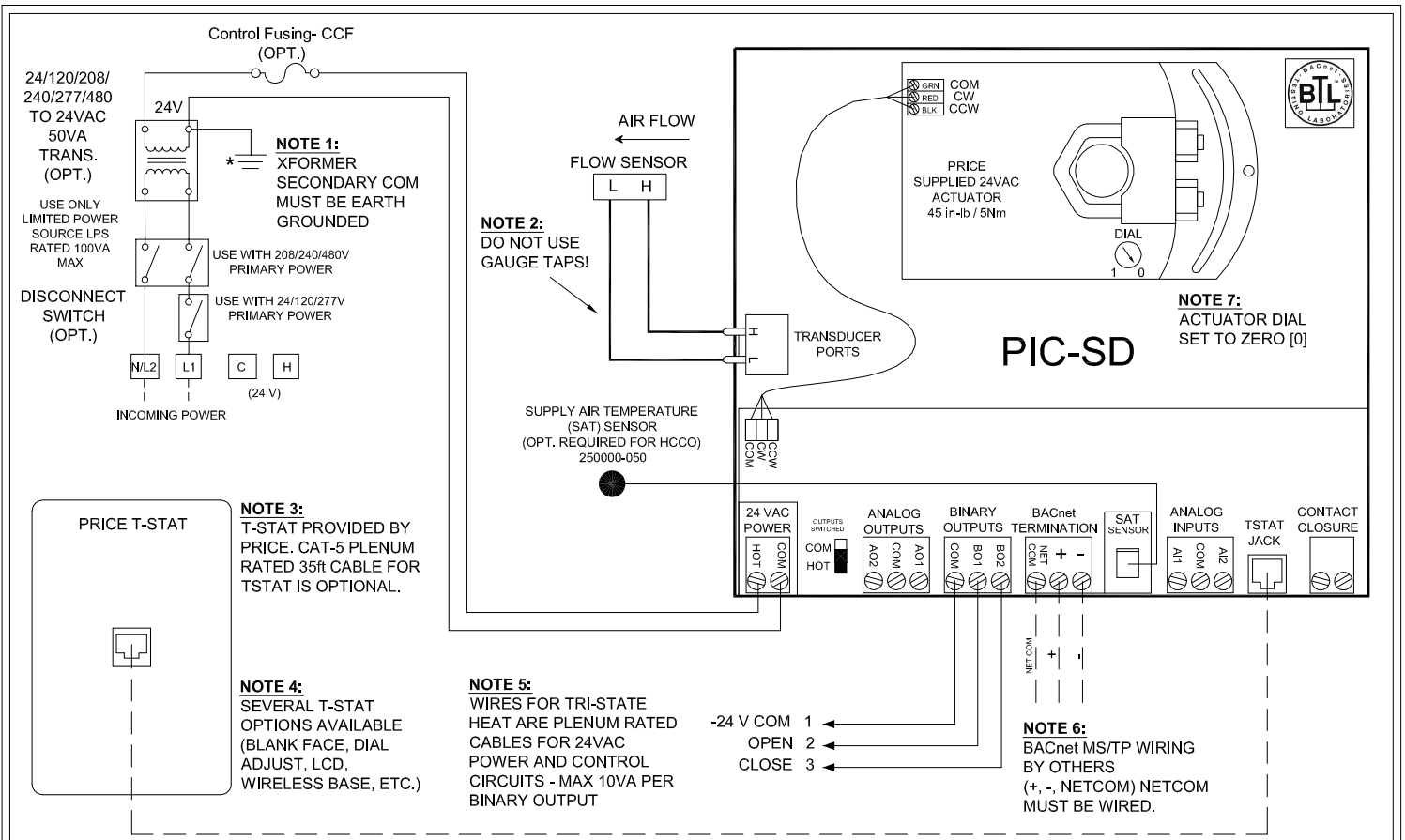

**LEGEND**

- FACTORY FLOW SENSOR TUBING
- FACTORY ELECTRICAL WIRING
- FIELD ELECTRICAL WIRING

**Calibration note:** Suitable min and max heating flows must be selected in order to maintain flow through energized electric coils of at least 200 fpm and at least 70 cfm/kW throughout the entire operating range.

**CONTROL GRAPH**

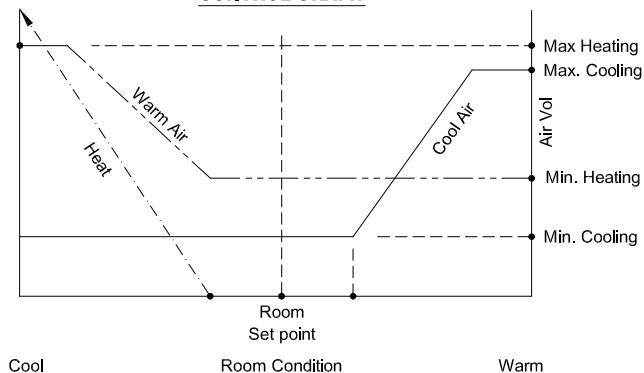

**Sequence of Operation (PIC-SD) -- Heat/cool changeover OR Cooling with Tri-State Modulating HW Reheat - Pressure Independent**

On power up the damper will calibrate closed for 2 minutes.  
 \*\*If no SAT sensor is present, the controller assumes Cool supply air at all times\*\*

**Cool supply air:** On an increase in space temperature the controller regulates the actuator to open the VAV damper and increase the flow of cool air. On an increase of space temperature greater than the cooling proportional band, the airflow is maintained at its pre-selected maximum setting.

On a decrease in space temperature the controller regulates the actuator to close the VAV damper and reduce the flow of cool air. If the space temperature decreases to less than the cooling proportional band, the airflow is maintained at the pre-selected minimum setting.

**Warm supply air:** On a decrease in space temperature the controller regulates the actuator to open the VAV damper and increase the flow of warm air. On a decrease of space temperature greater than the heating proportional band, the airflow is maintained at its pre-selected maximum setting.

On an increase in space temperature the controller regulates the actuator to close the VAV damper and reduce the flow of warm air. If the space temperature increases above the heating proportional band, the airflow is maintained at the pre-selected minimum setting.

**Reheat Operation:** On a decrease in space temperature, the heating valve is modulated to increase heat proportionally to the room demand.

**PROJECT:**

**ENGINEER:**

**CUSTOMER:**

**SUBMITTAL DATE:**

**SPEC. SYMBOL:**

**PRICE**<sup>®</sup>

*[Handwritten Signature]*

264668

2019/03/19

**SINGLE DUCT  
PIC-SD DDC**  
PRESSURE INDEPENDENT  
HEAT/COOL C/O OR COOLING WITH  
TRI-STATE MODULATING REHEAT  
FACTORY WIRED

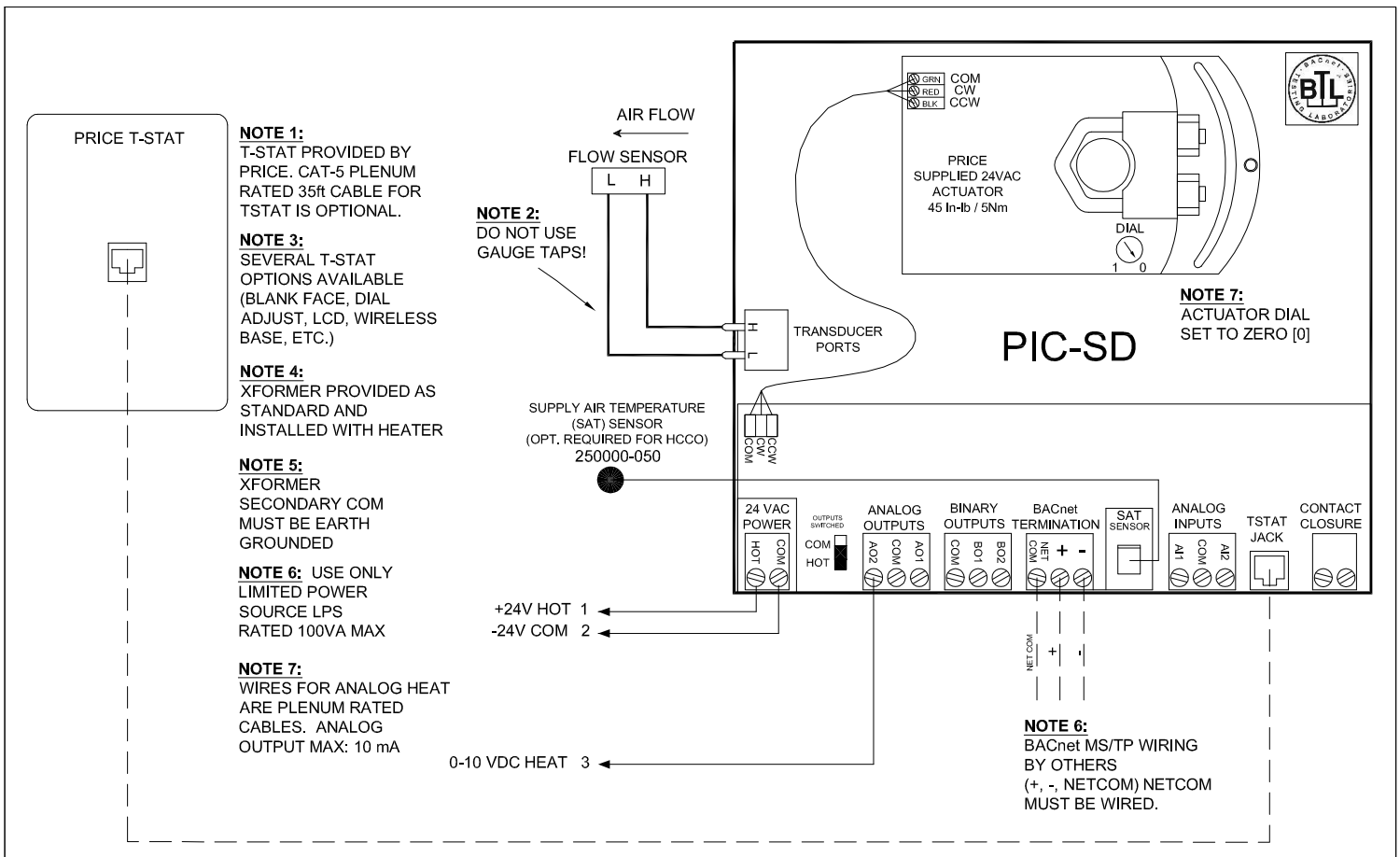

**LEGEND**

- FACTORY FLOW SENSOR TUBING
- FACTORY ELECTRICAL WIRING
- FIELD ELECTRICAL WIRING

**Calibration note:** Suitable min and max heating flows must be selected in order to maintain flow through energized electric coils of at least 200 fpm and at least 70 cfm/kW throughout the entire operating range.

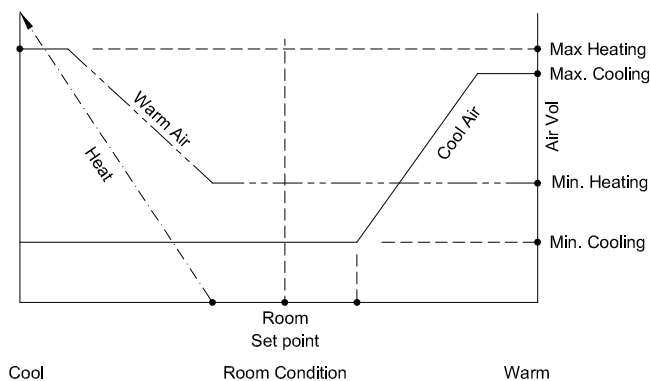

**Sequence of Operation (PIC-SD) -- Heat/cool changeover OR Cooling with Analog Modulating Reheat - Pressure Independent**

On power up the damper will calibrate closed for 2 minutes.

**\*\*If no SAT sensor is present, the controller assumes Cool supply air at all times\*\***

**Cool supply air:** On an increase in space temperature the controller regulates the actuator to open the VAV damper and increase the flow of cool air. On an increase of space temperature greater than the cooling proportional band, the airflow is maintained at its pre-selected maximum setting.

On a decrease in space temperature the controller regulates the actuator to close the VAV damper and reduce the flow of cool air. If the space temperature decreases to less than the cooling proportional band, the airflow is maintained at the pre-selected minimum setting.

**Warm supply air:** On a decrease in space temperature the controller regulates the actuator to open the VAV damper and increase the flow of warm air. On a decrease of space temperature greater than the heating proportional band, the airflow is maintained at its pre-selected maximum setting.

On an increase in space temperature the controller regulates the actuator to close the VAV damper and reduce the flow of warm air. If the space temperature increases above the heating proportional band, the airflow is maintained at the pre-selected minimum setting.

**Reheat Operation:** On a decrease in space temperature, the controller modulates the 0-10VDC output to increase the heat proportionally to the room demand.

**PROJECT:**

**ENGINEER:**

**CUSTOMER:**

**SUBMITTAL DATE:**

**SPEC. SYMBOL:**

**PRICE**<sup>®</sup>

*[Signature]*

264669

2019/03/19

**SINGLE DUCT  
PIC-SD DDC**  
PRESSURE INDEPENDENT  
HEAT/COOL C/O OR COOLING  
WITH ANALOG ELECTRIC REHEAT  
FACTORY WIRED

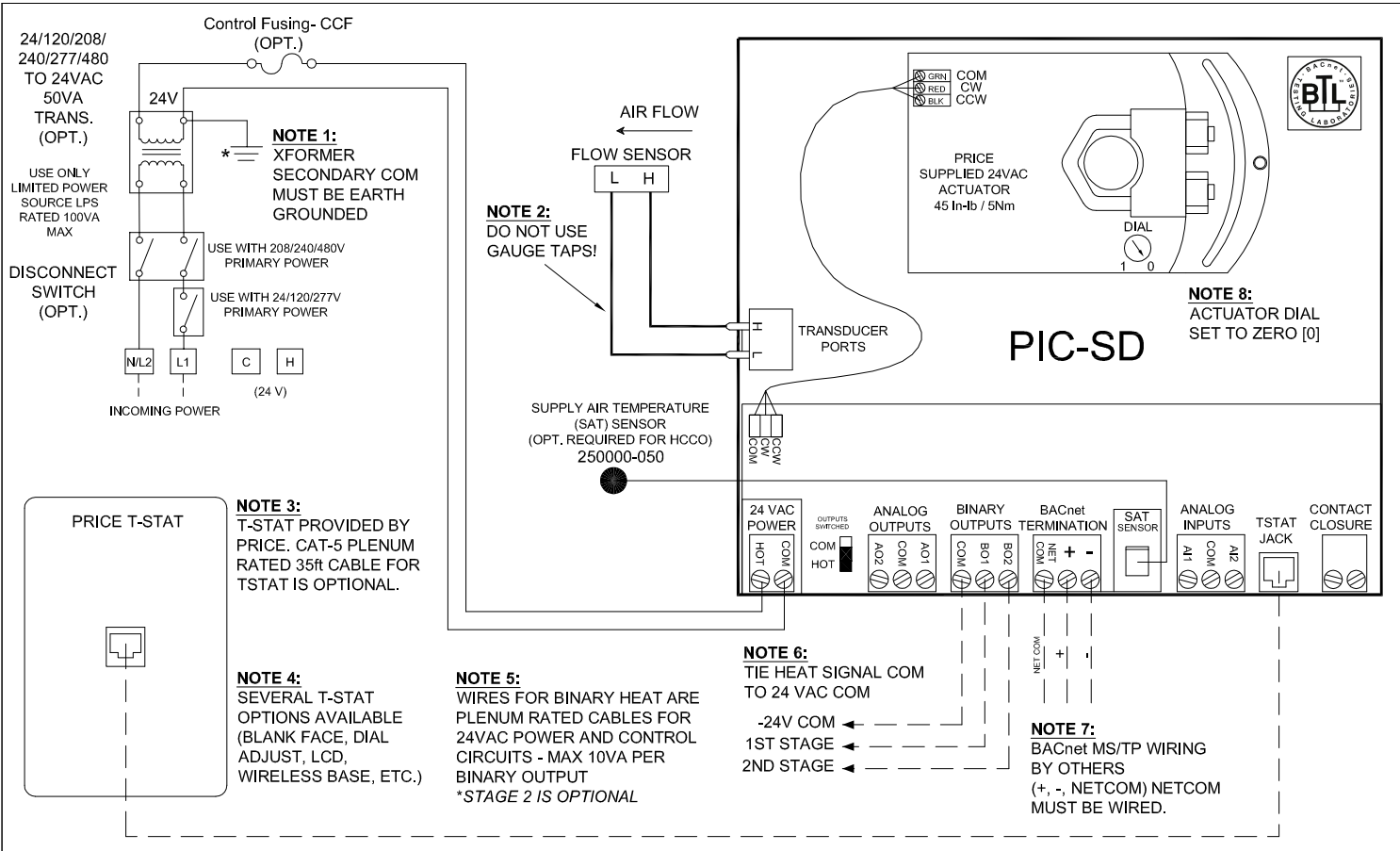

**LEGEND**

- FACTORY FLOW SENSOR TUBING
- FACTORY ELECTRICAL WIRING
- FIELD ELECTRICAL WIRING

**Calibration note:** Suitable min and max heating flows must be selected in order to maintain flow through energized electric coils of at least 200 fpm and at least 70 cfm/kW throughout the entire operating range.

**CONTROL GRAPH**

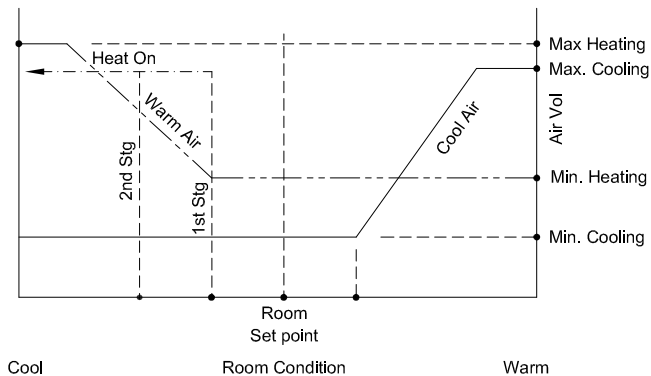

**Sequence of Operation (PIC-SD) -- Heat/cool changeover OR Cooling with up to 2 Stages of Binary Reheat - Pressure Independent**

On power up the damper will calibrate closed for 2 minutes.  
\*\*If no SAT sensor is present, the controller assumes cool supply air at all times\*\*

**Cool supply air:** On an increase in space temperature the controller regulates the actuator to open the VAV damper and increase the flow of cool air. On an increase of space temperature greater than the cooling proportional band, the airflow is maintained at its pre-selected maximum setting.

On a decrease in space temperature the controller regulates the actuator to close the VAV damper and reduce the flow of cool air. If the space temperature decreases to less than the cooling proportional band, the airflow is maintained at the pre-selected minimum setting.

**Warm supply air:** On a decrease in space temperature the controller regulates the actuator to open the VAV damper and increase the flow of warm air. On a decrease of space temperature greater than the heating proportional band, the airflow is maintained at its pre-selected maximum setting.

On an increase in space temperature the controller regulates the actuator to close the VAV damper and reduce the flow of warm air. If the space temperature increases above the heating proportional band, the airflow is maintained at the pre-selected minimum setting.

**Reheat Operation:** On a decrease in space temperature into the heating proportional band, the 1st stage binary 24VAC reheat output will energize. Upon further decreases, the 2nd stage of reheat will energize.

**PROJECT:**

**ENGINEER:**

**CUSTOMER:**

**SUBMITTAL DATE:**

**SPEC. SYMBOL:**

**PRICE**<sup>®</sup>

**SINGLE DUCT  
PIC-SD DDC**

PRESSURE INDEPENDENT  
HEAT/COOL C/O OR COOLING WITH  
UP TO 2 STAGES OF REHEAT  
FIELD WIRED

264670

2019/03/19

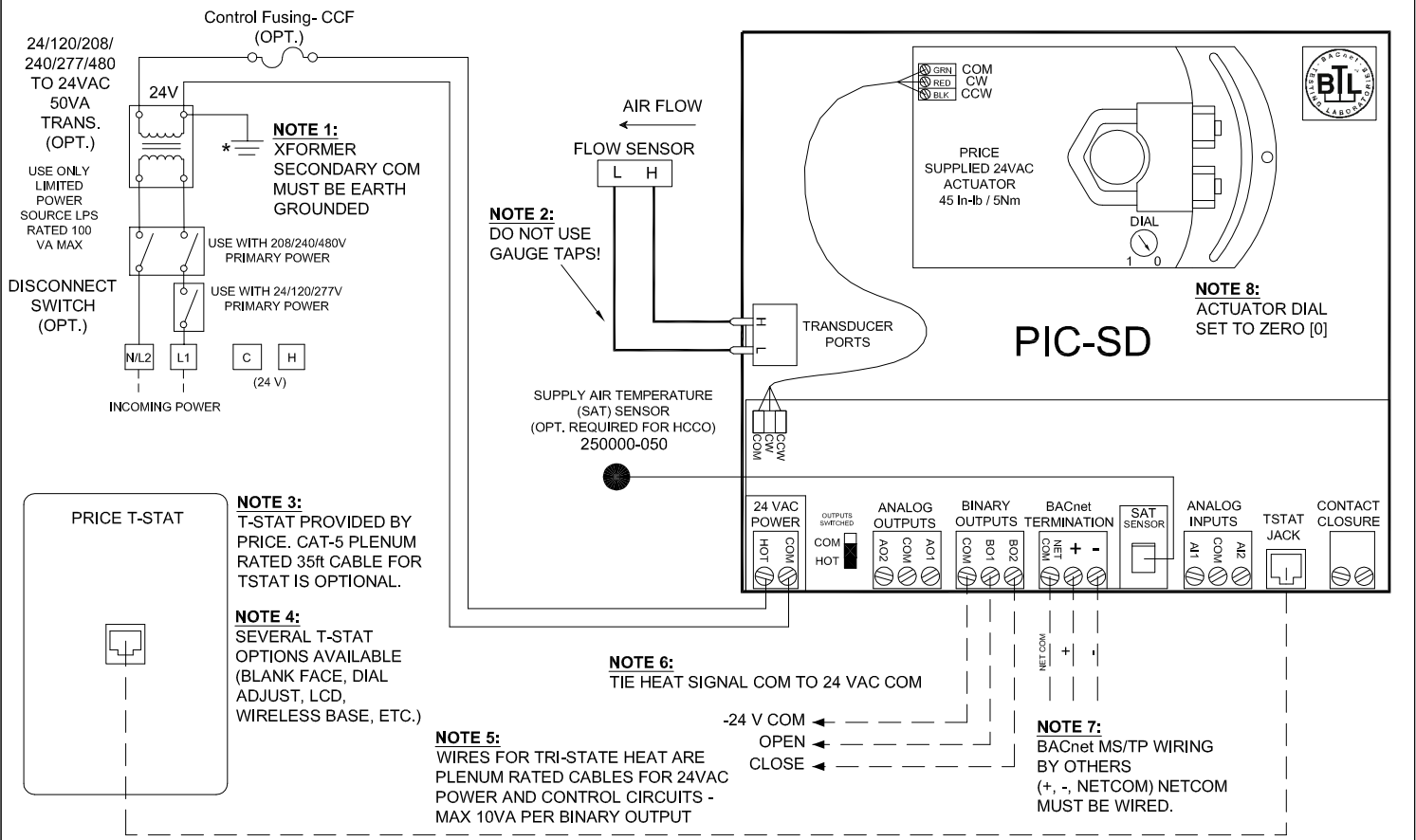

**LEGEND**

- FACTORY FLOW SENSOR TUBING
- FACTORY ELECTRICAL WIRING
- FIELD ELECTRICAL WIRING

**Calibration note:** Suitable min and max heating flows must be selected in order to maintain flow through energized electric coils of at least 200 fpm and at least 70 cfm/kW throughout the entire operating range.

**CONTROL GRAPH**

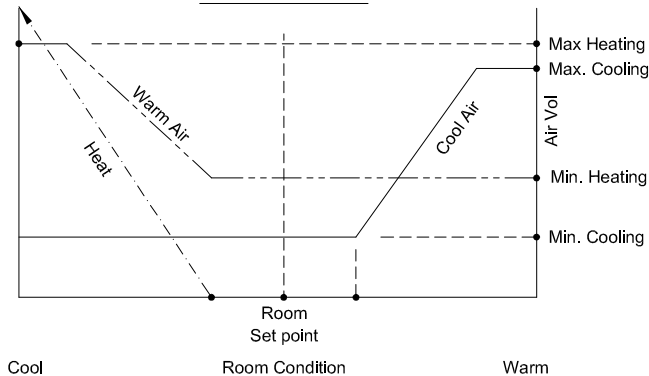

**Sequence of Operation (PIC-SD) -- Heat/cool changeover OR Cooling with Tri-State Modulating HW Reheat - Pressure Independent**

On power up the damper will calibrate closed for 2 minutes.  
 \*\*If no SAT sensor is present, the controller assumes Cool supply air at all times\*\*  
**Cool supply air:** On an increase in space temperature the controller regulates the actuator to open the VAV damper and increase the flow of cool air. On an increase of space temperature greater than the cooling proportional band, the airflow is maintained at its pre-selected maximum setting.  
 On a decrease in space temperature the controller regulates the actuator to close the VAV damper and reduce the flow of cool air. If the space temperature decreases to less than the cooling proportional band, the airflow is maintained at the pre-selected minimum setting.  
**Warm supply air:** On a decrease in space temperature the controller regulates the actuator to open the VAV damper and increase the flow of warm air. On a decrease of space temperature greater than the heating proportional band, the airflow is maintained at its pre-selected maximum setting.  
 On an increase in space temperature the controller regulates the actuator to close the VAV damper and reduce the flow of warm air. If the space temperature increases above the heating proportional band, the airflow is maintained at the pre-selected minimum setting.  
**Reheat Operation:** On a decrease in space temperature, the heating valve is modulated to increase heat proportionally to the room demand.

**PROJECT:**

**ENGINEER:**

**CUSTOMER:**

**SUBMITTAL DATE:**

**SPEC. SYMBOL:**



**SINGLE DUCT  
PIC-SD DDC**

PRESSURE INDEPENDENT  
HEAT/COOL C/O OR COOLING WITH  
TRI-STATE MODULATING REHEAT  
FIELD WIRED

264671

2019/03/19



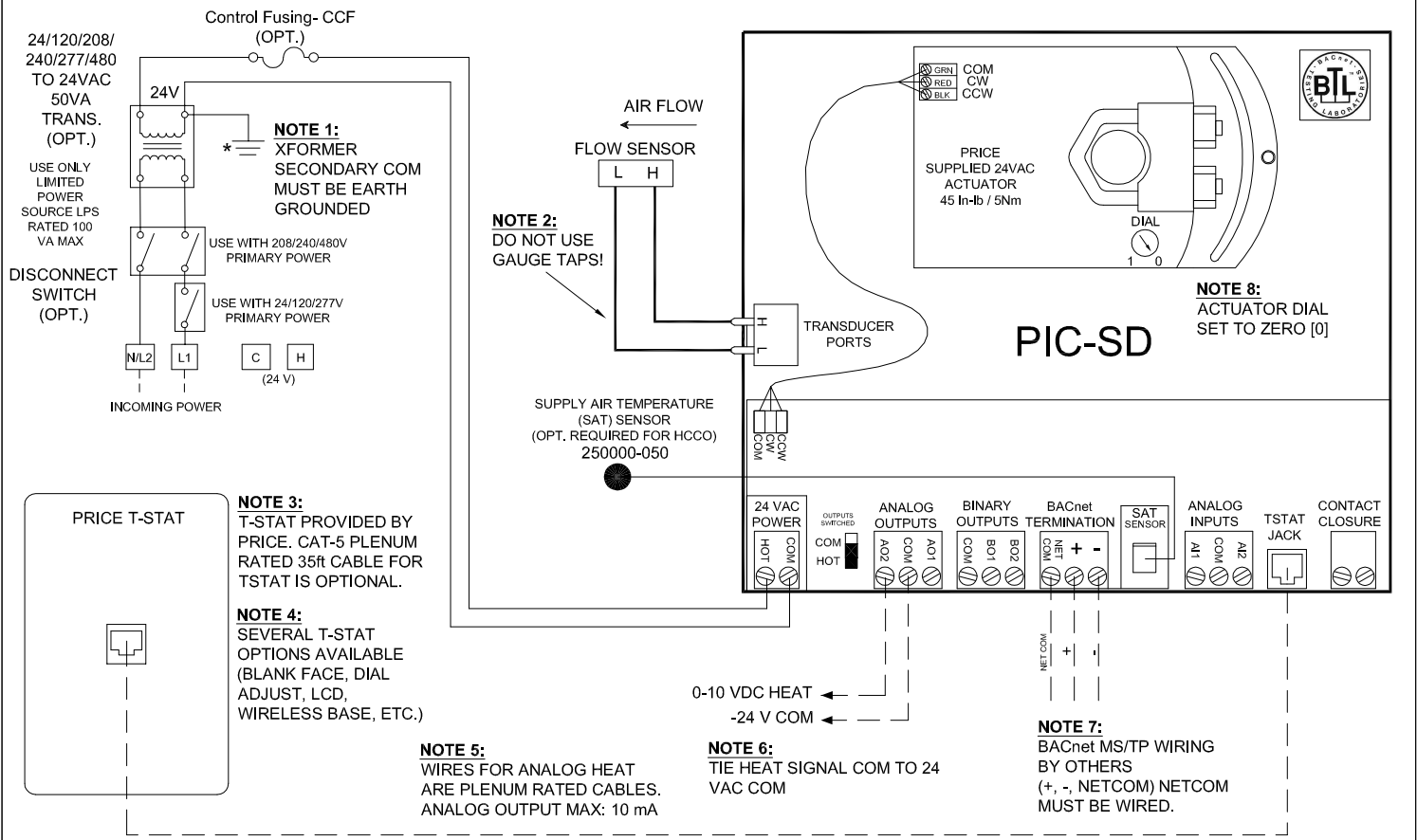

**LEGEND**

- FACTORY FLOW SENSOR TUBING
- FACTORY ELECTRICAL WIRING
- FIELD ELECTRICAL WIRING

**Calibration note:** Suitable min and max heating flows must be selected in order to maintain flow through energized electric coils of at least 200 fpm and at least 70 cfm/kW throughout the entire operating range.

**CONTROL GRAPH**

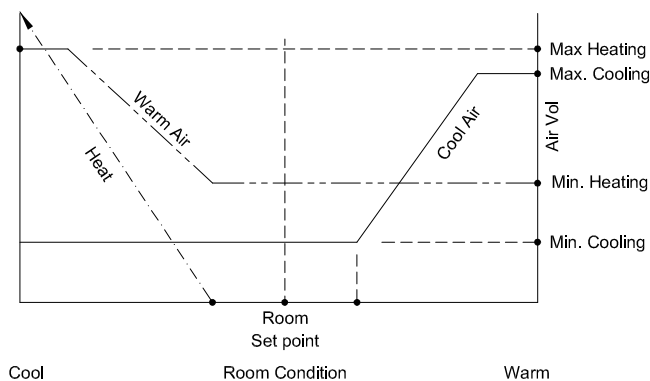

**Sequence of Operation (PIC-SD) -- Heat/cool changeover OR Cooling with Analog Modulating Reheat - Pressure Independent**

On power up the damper will calibrate closed for 2 minutes.

**\*\*If no SAT sensor is present, the controller assumes Cool supply air at all times\*\***

**Cool supply air:** On an increase in space temperature the controller regulates the actuator to open the VAV damper and increase the flow of cool air. On an increase of space temperature greater than the cooling proportional band, the airflow is maintained at its pre-selected maximum setting.

On a decrease in space temperature the controller regulates the actuator to close the VAV damper and reduce the flow of cool air. If the space temperature decreases to less than the cooling proportional band, the airflow is maintained at the pre-selected minimum setting.

**Warm supply air:** On a decrease in space temperature the controller regulates the actuator to open the VAV damper and increase the flow of warm air. On a decrease of space temperature greater than the heating proportional band, the airflow is maintained at its pre-selected maximum setting.

On an increase in space temperature the controller regulates the actuator to close the VAV damper and reduce the flow of warm air. If the space temperature increases above the heating proportional band, the airflow is maintained at the pre-selected minimum setting.

**Reheat Operation:** On a decrease in space temperature, the controller modulates the 0-10VDC output to increase the heat proportionally to the room demand.

**PROJECT:**

**ENGINEER:**

**CUSTOMER:**

**SUBMITTAL DATE:**

**SPEC. SYMBOL:**

*Handwritten signature*

264672

2019/03/19



**SINGLE DUCT  
PIC-SD DDC**

PRESSURE INDEPENDENT  
HEAT/COOL C/O OR COOLING  
WITH ANALOG ELECTRIC REHEAT  
FIELD WIRED

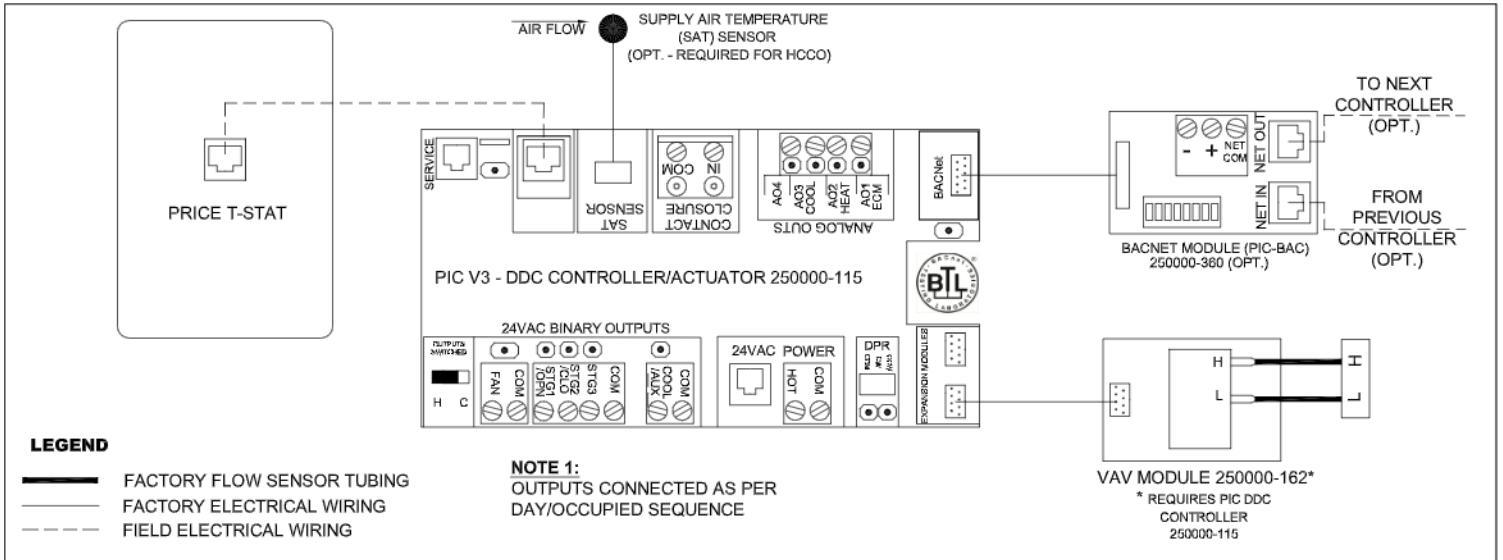

**Entering and Exiting Night Setback:** There are several methods for the PIC to enter and exit night setback (unoccupied mode). All of the following methods can be enabled or disabled in software or from the T-Stat menu.

- 1. Airflow Failure:** (Disabled by default) If using a Pressure Independent day sequence (with the PIC-VAV module), the controller will enter night setback when minimal airflow is sensed in the duct. The controller does this based on Day Flow Trip and Night Flow Trip (adjustable). *Day Flow Trip* is enabled when the controller sees more than 1/2 of its minimum airflow - i.e. min airflow = 132 cfm, Day Flow Trip = 66 cfm. *Night Flow Trip* is enabled when the controller sees less than 1/2 of its day flow trip value - i.e. 33 cfm
- 2. Motion Sensor:** (Disabled by default) If a motion sensor T-Stat is used, the controller can enter night setback if no motion has been detected in the space for a specified period of time (default: 4 hours).
- 3. Contact Closure:** (Disabled by default) Connecting the two contact closure inputs together using a dry contact will cause the controller to enter night setback. The controller will exit night setback once the contacts are released.
- 4. T-Stat Button:** The T-Stat button allows the user to exit night setback. Pressing any button on the T-Stat will cause the controller to exit night setback for the override time period. (default: 4 hours). Occupancy override by T-Stat button is always enabled and cannot be disabled.

**CONTROL GRAPH - SDV8**

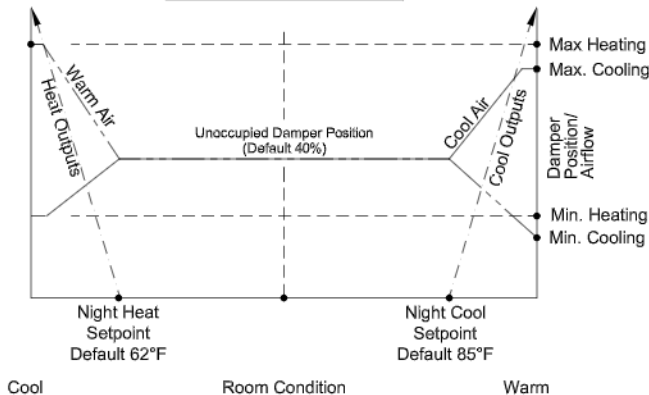

**Sequence of Operation -- SINGLE DUCT TERMINAL UNIT - PIC CONTROLLER - NIGHT SETBACK**

During night setback, the controller will respond to its night heat setpoint and its night cool setpoint.

While the room temperature is between the two night setpoints, by default the controller will maintain the damper position at 40% open. All outputs (Fan, Heat, etc.) will go to their OFF or IDLE states.

**Room temperature below Night Heat Setpoint:**

**Reheat Operation:** On a decrease in space temperature into the heating proportional band, the reheat outputs (if used) are energized proportionally.

**Cool supply air:** On a decrease in space temperature the controller regulates the actuator to close the VAV damper and reduce the flow of cool air. The airflow is maintained at the pre-selected minimum setting.

**Warm supply air:** On a decrease in space temperature the controller regulates the actuator to open the VAV damper and increase the flow of warm air. On a decrease of space temperature greater than the heating proportional band, the airflow is maintained at its pre-selected maximum setting.

**Room temperature above Night Cool Setpoint:**

**Cooling Output Operation:** On an increase in space temperature into the cooling proportional band, the cooling outputs (if used) are energized proportionally.

**Cool supply air:** On an increase in space temperature the controller regulates the actuator to open the VAV damper and increase the flow of cool air. On an increase of space temperature greater than the cooling proportional band, the airflow is maintained at its pre-selected maximum setting.

**Warm supply air:** On an increase in space temperature the controller regulates the actuator to close the VAV damper and reduce the flow of warm air. The airflow is maintained at the pre-selected minimum setting.

<b>PROJECT:</b>		<b>PRICE</b> <sup>®</sup>
<b>ENGINEER:</b>		
<b>CUSTOMER:</b>		<b>SINGLE DUCT TERMINAL UNIT NIGHT SETBACK SEQUENCE</b>
<b>SUBMITTAL DATE:</b>		PIC - DDC CONTROLLER SDV8
<b>SPEC. SYMBOL:</b>		249529
		2015/01/29

**NOTE 6:**  
USE RJ45 JACKS FOR BACNET CONNECTION, OR 3 POSITION TERMINAL BLOCK FOR 3-WIRE CONNECTION (+, -, NETCOM) NETCOM MUST BE WIRED.

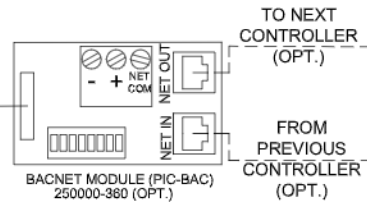

**NOTE 5:**  
A CAT-5 BACNET NETWORK CABLE IS PROVIDED BY PRICE WITH EACH CONTROLLER ORDERED WITH THE BACNET OPTION

**NOTE 3:**  
STATIC PRESSURE SETPOINT IS FACTORY CALIBRATED TO 0.3" W.C.  
IT CAN BE CHANGED IN THE FIELD USING EITHER:  
1. BACnet FRONT END  
2. PRICE USB **LINKER** INTERFACE  
3. **LCD-SETUP** TOOL (OR ANY PIC/PRODIGY LCD T-STAT)

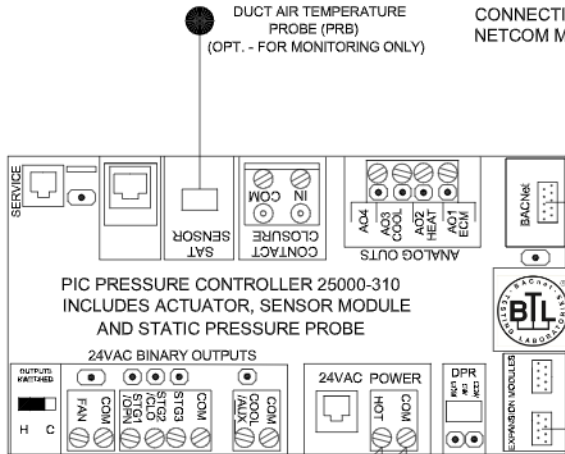

**NOTE 1:**  
24 VAC POWER SOURCE MUST BE FIELD WIRED IF OPTIONAL TRANSFORMER IS NOT PROVIDED.

TRANSFORMER SECONDARY COM MUST BE EARTH GROUNDED

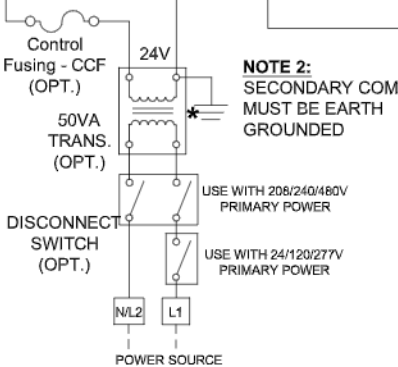
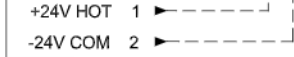

SENSOR MODULE - INCLUDED IN 250000-310  
REPLACEMENT PART - 250000-170

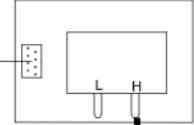

**NOTE 4:**  
MEASURE STATIC PRESSURE APPROXIMATELY 2/3 OF THE WAY DOWN THE MAIN DUCT.

LOW PORT (L) ON THE PRESSURE SENSOR MUST NOT BE OBSTRUCTED

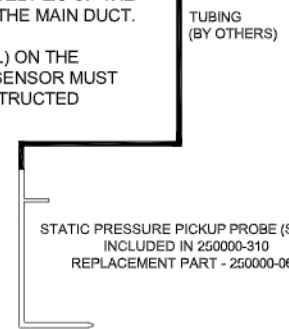

### LEGEND

- FIELD INSTALLED SENSOR TUBING
- FACTORY ELECTRICAL WIRING
- FIELD ELECTRICAL WIRING

### CONTROL GRAPH

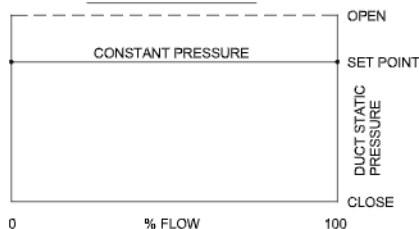

### Sequence of Operation -- Constant Pressure, Bypass.

On startup, the controller will calibrate to the fully-open position for 2 minutes.

On an increase in duct static pressure the controller/actuator will open the VAV damper to increase the amount of air bypassed.

On a decrease in duct static pressure the controller/actuator will close the VAV damper to reduce the amount of air by-passed. Duct static pressure is held constant.

Upon detection of air handler shutdown (Zero duct pressure with bypass damper fully closed), the controller/actuator will place the damper at the pre-selected setback position (default: 50 % open)

**PROJECT:**

**ENGINEER:**

**CUSTOMER:**

**SUBMITTAL DATE:**

**SPEC. SYMBOL:**

*BE MB*

256047

2011/07/29

# PRICE®

**PCV  
PIC PRESSURE CONTROLLER**  
PRICE INTELLIGENT CONTROLLER  
CONSTANT PRESSURE  
BYPASS  
DIGITAL S.P. ADJUST

**NOTE 6:**  
USE RJ45 JACKS FOR BACNET CONNECTION, OR 3 POSITION TERMINAL BLOCK FOR 3-WIRE CONNECTION (+, -, NETCOM) NETCOM MUST BE WIRED.

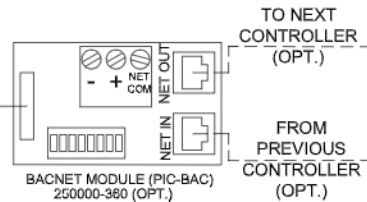

**NOTE 5:**  
A CAT-5 BACNET NETWORK CABLE IS PROVIDED BY PRICE WITH EACH CONTROLLER ORDERED WITH THE BACNET OPTION

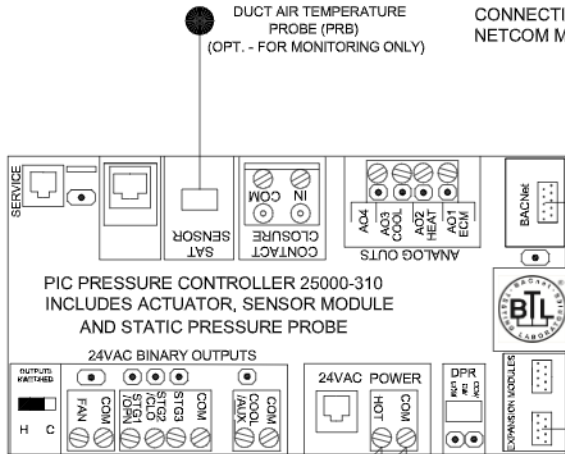

**NOTE 3:**  
STATIC PRESSURE SETPOINT IS FACTORY CALIBRATED TO 0.3" W.C.  
IT CAN BE CHANGED IN THE FIELD USING EITHER:  
1. BACnet FRONT END  
2. PRICE USB **LINKER** INTERFACE  
3. **LCD-SETUP** TOOL (OR ANY PIC/PRODIGY LCD T-STAT)

**NOTE 1:**  
24 VAC POWER SOURCE MUST BE FIELD WIRED IF OPTIONAL TRANSFORMER IS NOT PROVIDED.  
  
TRANSFORMER SECONDARY COM MUST BE EARTH GROUNDED

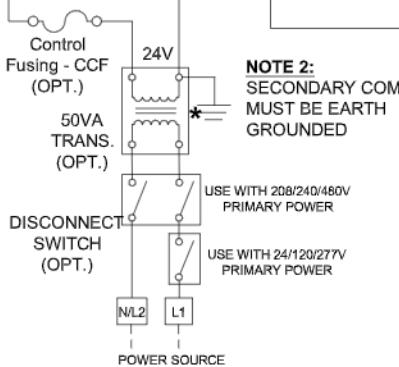
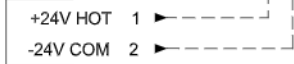

**NOTE 2:**  
SECONDARY COM MUST BE EARTH GROUNDED

**NOTE 4:**  
MEASURE STATIC PRESSURE APPROXIMATELY 2/3 OF THE WAY DOWN THE MAIN DUCT.  
  
LOW PORT (L) ON THE PRESSURE SENSOR MUST NOT BE OBSTRUCTED

SENSOR MODULE - INCLUDED IN 250000-310  
REPLACEMENT PART - 250000-170

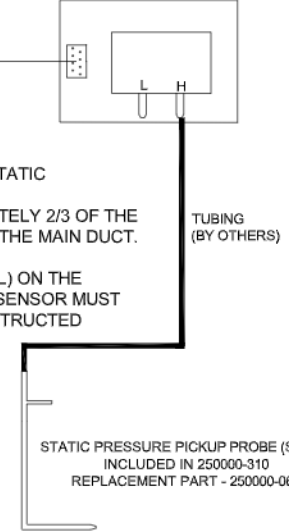

**LEGEND**

- FIELD INSTALLED SENSOR TUBING
- FACTORY ELECTRICAL WIRING
- FIELD ELECTRICAL WIRING

**CONTROL GRAPH**

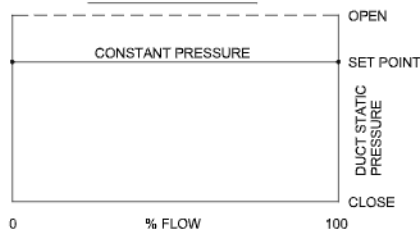

**Sequence of Operation -- Constant Pressure, Downstream.**

On startup, the controller will calibrate to the fully-closed position for 2 minutes.

On an increase in duct static pressure the controller/actuator will close the VAV damper to decrease the amount of air delivered downstream of the box.

On a decrease in duct static pressure the controller/actuator will open the VAV damper to increase the amount of air delivered downstream of the box.

Duct static pressure is held constant.

Upon detection of air handler shutdown (Zero duct pressure with VAV damper fully open), the controller/actuator will place the damper at the pre-selected setback position (default: 50 % open)

**PROJECT:**

**ENGINEER:**

**CUSTOMER:**

**SUBMITTAL DATE:**

**SPEC. SYMBOL:**

<b>PRICE</b> <sup>®</sup>	
<i>BE MB</i>	<b>PCV PIC PRESSURE CONTROLLER</b>
256048	PRICE INTELLIGENT CONTROLLER CONSTANT PRESSURE DOWNSTREAM DIGITAL S.P. ADJUST
2017/15/12	



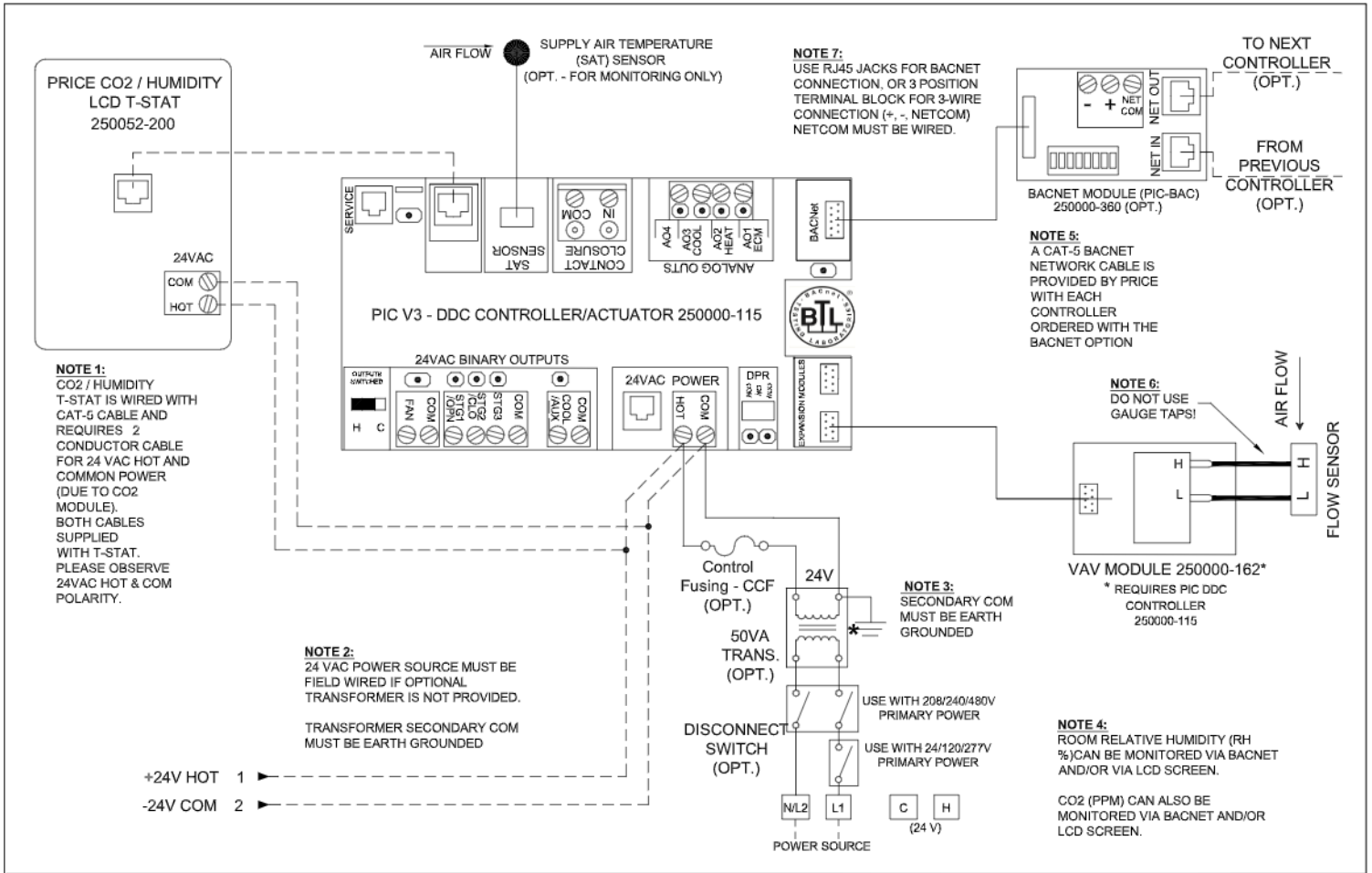

**LEGEND**

- FACTORY FLOW SENSOR TUBING
- FACTORY ELECTRICAL WIRING
- FIELD ELECTRICAL WIRING

**CONTROL GRAPH**

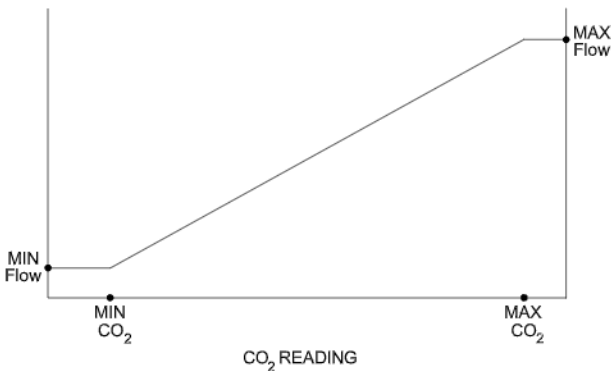

**Sequence of Operation -- CO<sub>2</sub> Tracking, Variable Volume, Pressure Independent**

On power up the damper will calibrate closed for 2 minutes.

**The PIC Controller** shall maintain an airflow through the VAV terminal that is directly proportional to the CO<sub>2</sub> level in the occupied space. CO<sub>2</sub> is measured at the Price CO<sub>2</sub> thermostat.

As the CO<sub>2</sub> reading increases from the minimum level to the maximum level (adjustable), the airflow is increased proportionally between the adjustable minimum and maximum airflow setpoints.

As the CO<sub>2</sub> reading decreases from the maximum level to the minimum level (adjustable), the airflow is decreased proportionally between the adjustable minimum and maximum airflow setpoints.

**PROJECT:**

**ENGINEER:**

**CUSTOMER:**

**SUBMITTAL DATE:**

**SPEC. SYMBOL:**

**PRICE**<sup>®</sup>

*BE MB*

**SINGLE DUCT  
PIC DDC**

PRESSURE INDEPENDENT  
VARIABLE VOLUME  
CO<sub>2</sub> AIRFLOW TRACKING

259561

2017/06/26

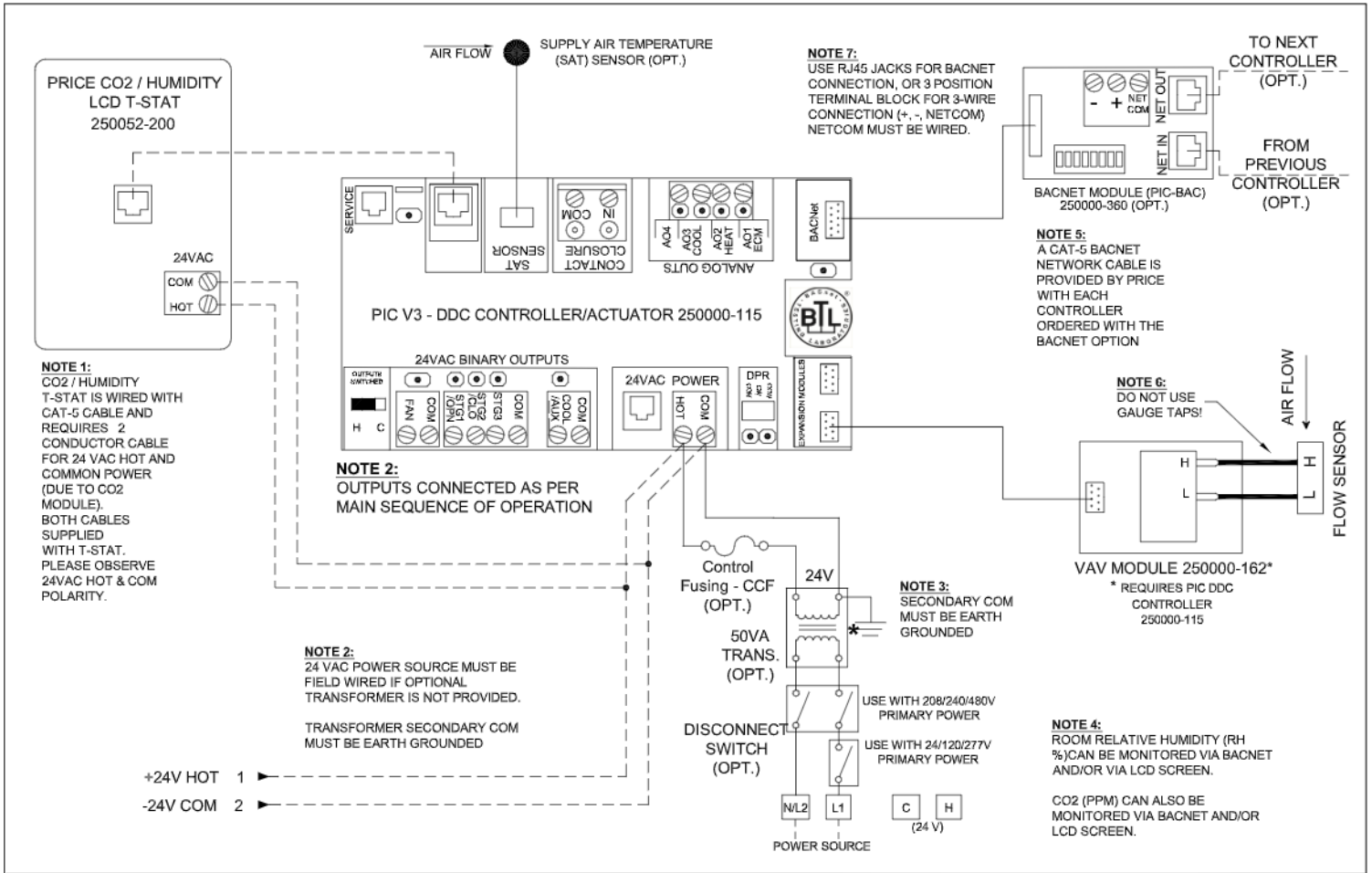

**LEGEND**

- FACTORY FLOW SENSOR TUBING
- FACTORY ELECTRICAL WIRING
- FIELD ELECTRICAL WIRING

**CONTROL GRAPH**

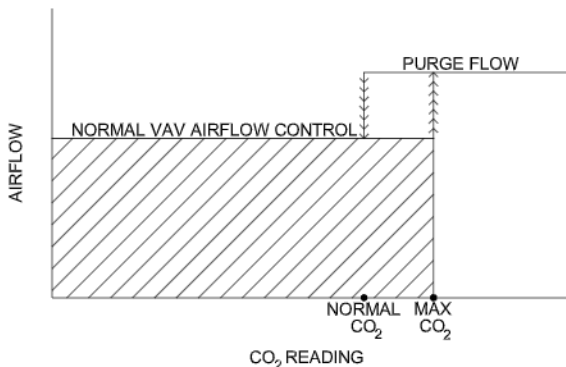

**Sequence of Operation -- CO<sub>2</sub> Purge, Pressure Independent**

\*Secondary control sequence. Adds functionality to standard terminal unit control sequences (280x, 680x, 880x) with the CO<sub>2</sub>/humidity T-stat Part #250052-200.

**NORMAL OPERATION**

While the CO<sub>2</sub> reading in the occupied space is below the adjustable maximum level, the terminal unit is controlled as per the selected standard control sequence (280x, 680x, 880x).

**CO<sub>2</sub> PURGE**

If the CO<sub>2</sub> reading in the occupied space rises above the adjustable maximum level, the controller will regulate the VAV damper to increase the airflow into the space to the adjustable "CO<sub>2</sub> Purge" airflow setting.

Once the CO<sub>2</sub> reading drops to the normal CO<sub>2</sub> level, the controller will resume normal operation.

**REHEAT OPERATION**

The controller will energize reheat (as directed by the standard control sequence) in both Normal and CO<sub>2</sub> Purge operating modes.

**PROJECT:**

**ENGINEER:**

**CUSTOMER:**

**SUBMITTAL DATE:**

**SPEC. SYMBOL:**

<b>PRICE</b> <sup>®</sup>	
<i>BE MB</i>	<b>TERMINAL CONTROLS PIC DDC</b>
259562	PRESSURE INDEPENDENT CO <sub>2</sub> PURGE
2017/06/26	ADDS FUNCTIONALITY TO STD TERMINAL CONTROL SEQUENCES

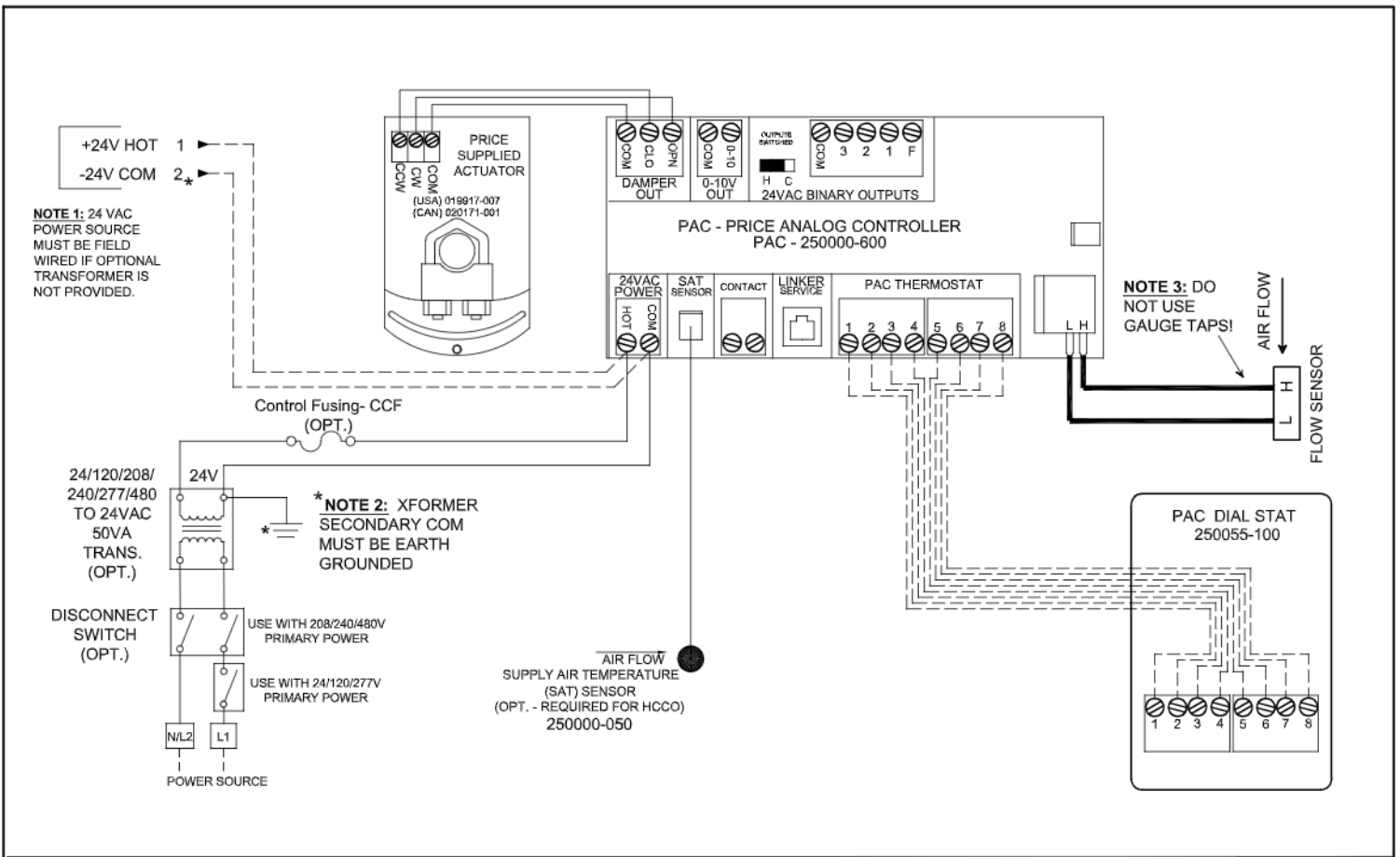

**LEGEND**

- FACTORY FLOW SENSOR TUBING
- FACTORY ELECTRICAL WIRING
- FIELD ELECTRICAL WIRING

**CONTROL GRAPH**

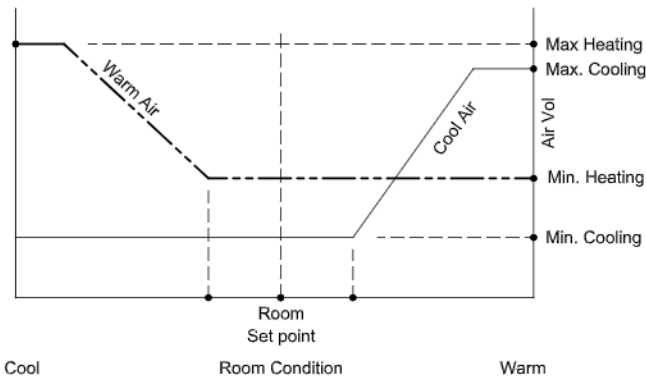

**Sequence of Operation – Heat/cool changeover OR cooling only Pressure Independent**

On power up the damper will calibrate closed for 2 minutes.

\*\*If no SAT sensor is present, the controller assumes Cool supply air at all times\*\*

**Cool supply air:** On an increase in space temperature the controller regulates the actuator to open the VAV damper and increase the flow of cool air. On an increase of space temperature greater than the cooling proportional band, the airflow is maintained at its pre-selected maximum setting.

On a decrease in space temperature the controller regulates the actuator to close the VAV damper and reduce the flow of cool air. If the space temperature decreases to less than the cooling proportional band, the airflow is maintained at the pre-selected minimum setting.

**Warm supply air:** On a decrease in space temperature the controller regulates the actuator to open the VAV damper and increase the flow of warm air. On a decrease of space temperature greater than the heating proportional band, the airflow is maintained at its pre-selected maximum setting.

On an increase in space temperature the controller regulates the actuator to close the VAV damper and reduce the flow of warm air. If the space temperature increases above the heating proportional band, the airflow is maintained at the pre-selected minimum setting.

**PROJECT:**

**ENGINEER:**

**CUSTOMER:**

**SUBMITTAL DATE:**

**SPEC. SYMBOL:**



*KR/mm*

254832

2012/11/13

**SINGLE DUCT  
PAC**  
PRESSURE INDEPENDENT  
HEAT/COOL CHANGEOVER  
OR COOLING ONLY  
NO LOCAL REHEAT CONTROL

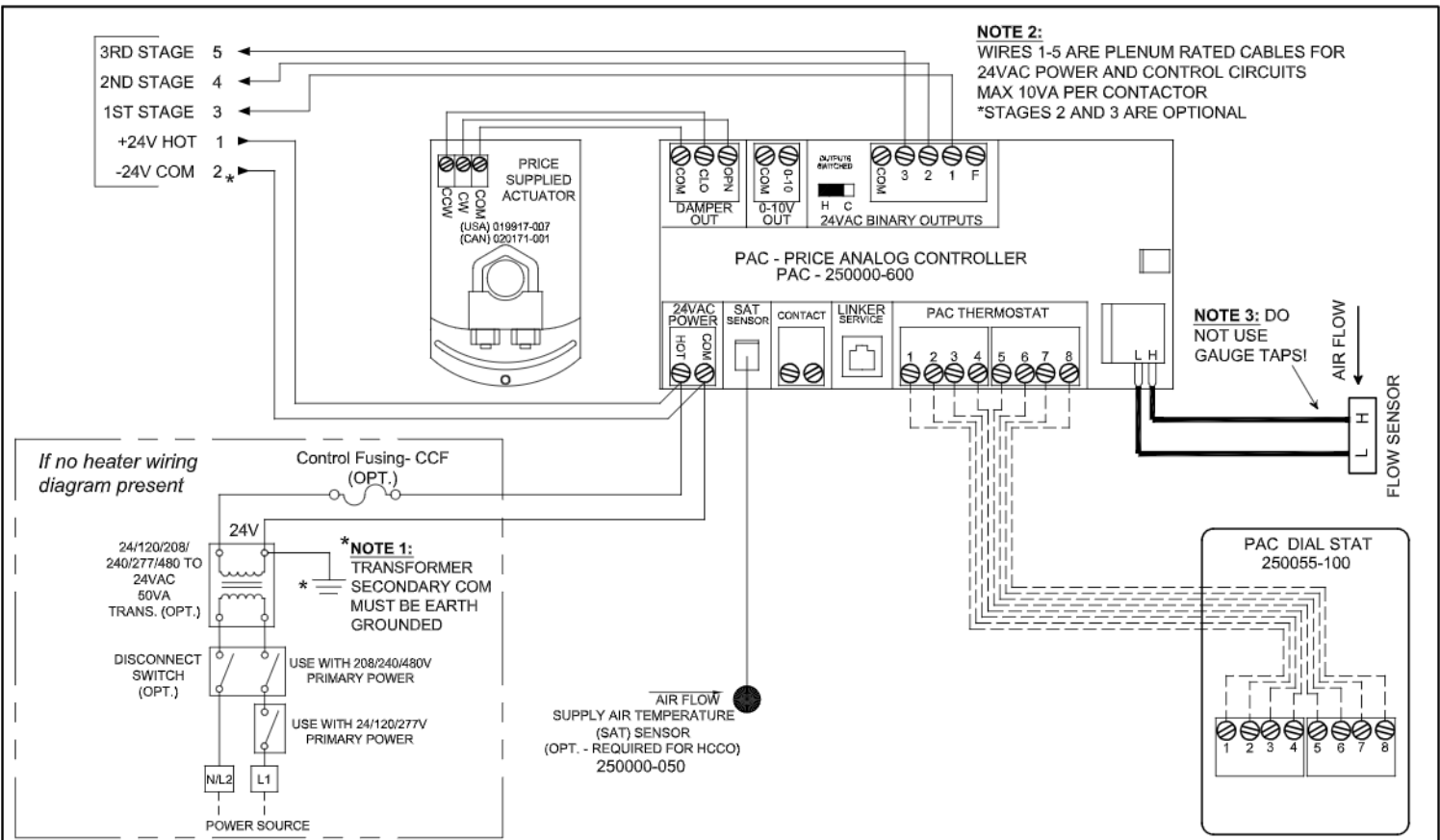

**Calibration note:** Suitable min and max heating flows must be selected in order to maintain flow through energized electric coils of at least 200 fpm and at least 70 cfm/kW throughout the entire operating range.

**LEGEND**

- FACTORY FLOW SENSOR TUBING
- FACTORY ELECTRICAL WIRING
- FIELD ELECTRICAL WIRING

**CONTROL GRAPH**

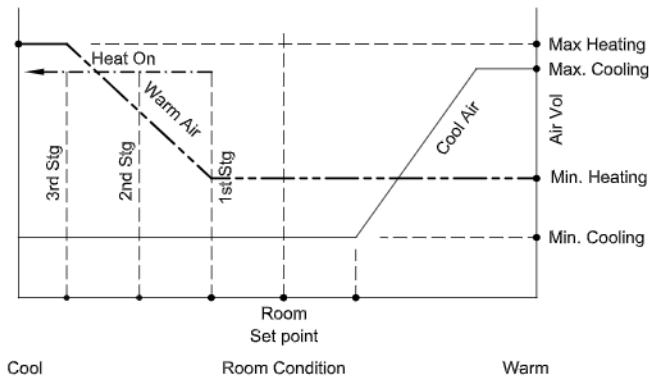

**Sequence of Operation -- Heat/cool changeover OR cooling  
With up to 3 stage binary reheat - Pressure Independent**

On power up the damper will calibrate closed for 2 minutes.  
\*\*If no SAT sensor is present, the controller assumes Cool supply air at all times\*\*

**Cool supply air:** On an increase in space temperature the controller regulates the actuator to open the VAV damper and increase the flow of cool air. On an increase of space temperature greater than the cooling proportional band, the airflow is maintained at its pre-selected maximum setting.

On a decrease in space temperature the controller regulates the actuator to close the VAV damper and reduce the flow of cool air. If the space temperature decreases to less than the cooling proportional band, the airflow is maintained at the pre-selected minimum setting.

**Warm supply air:** On a decrease in space temperature the controller regulates the actuator to open the VAV damper and increase the flow of warm air. On a decrease of space temperature greater than the heating proportional band, the airflow is maintained at its pre-selected maximum setting.

On an increase in space temperature the controller regulates the actuator to close the VAV damper and reduce the flow of warm air. If the space temperature increases above the heating proportional band, the airflow is maintained at the pre-selected minimum setting.

**Reheat Operation:** On a decrease in space temperature into the heating proportional band, the 1st stage binary 24VAC reheat output will energize. Upon further decreases, the 2nd then 3rd stages of reheat (if used) will energize.

**PROJECT:**

**ENGINEER:**

**CUSTOMER:**

**SUBMITTAL DATE:**

**SPEC. SYMBOL:**



*KR/mm*

254833

2012/11/13

**SINGLE DUCT  
PAC**  
PRESSURE INDEPENDENT  
HEAT/COOL C/O OR COOLING  
WITH UP TO 3 STG BINARY REHEAT



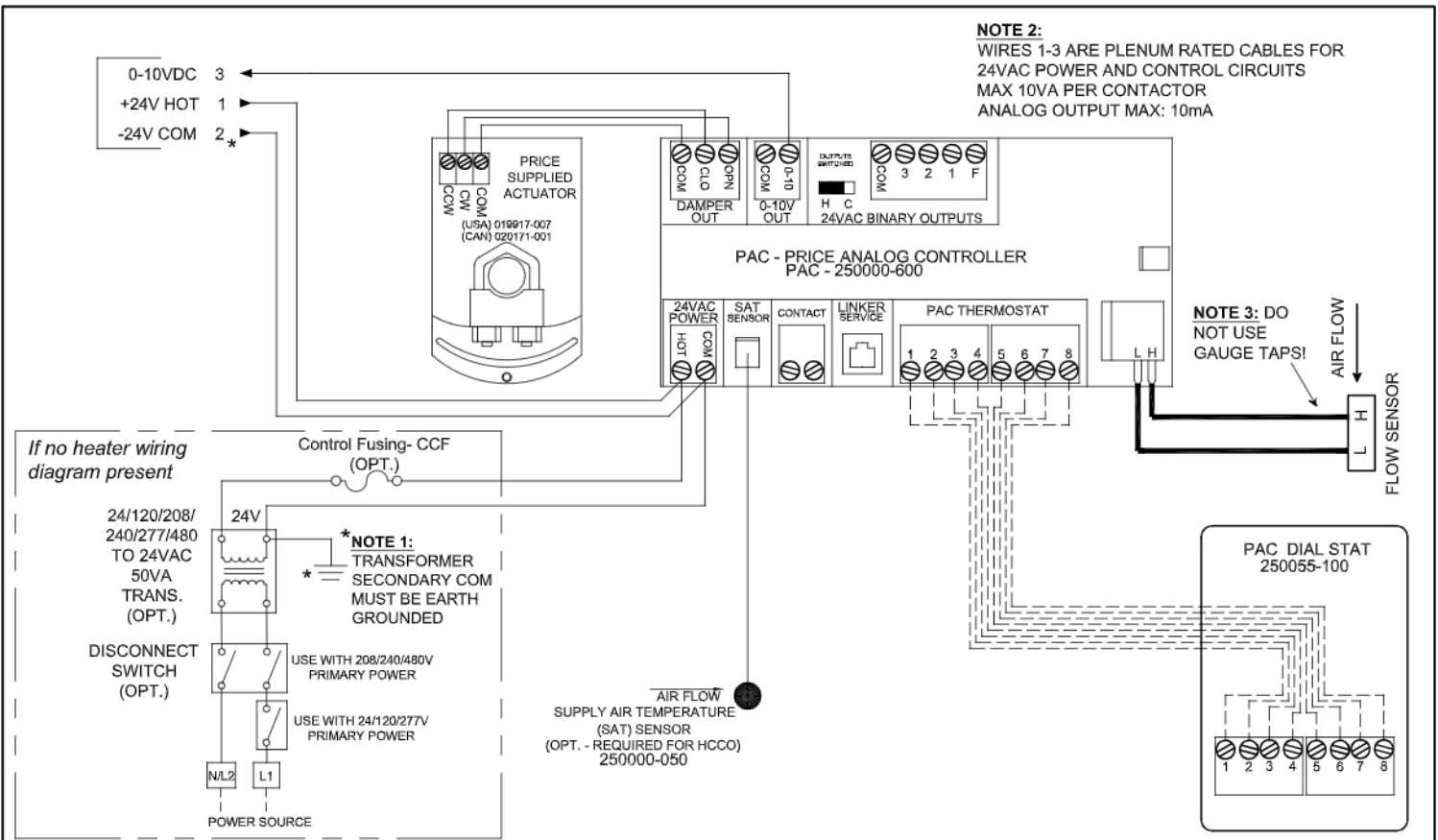

**Calibration note:** Suitable min and max heating flows must be selected in order to maintain flow through energized electric coils of at least 200 fpm and at least 70 cfm/kW throughout the entire operating range.

**Sequence of Operation -- Heat/cool changeover OR cooling With Analog modulating reheat - Pressure Independent**

On power up the damper will calibrate closed for 2 minutes.  
\*\*If no SAT sensor is present, the controller assumes Cool supply air at all times\*\*

**LEGEND**

- FACTORY FLOW SENSOR TUBING
- FACTORY ELECTRICAL WIRING
- - - - - FIELD ELECTRICAL WIRING

**CONTROL GRAPH**

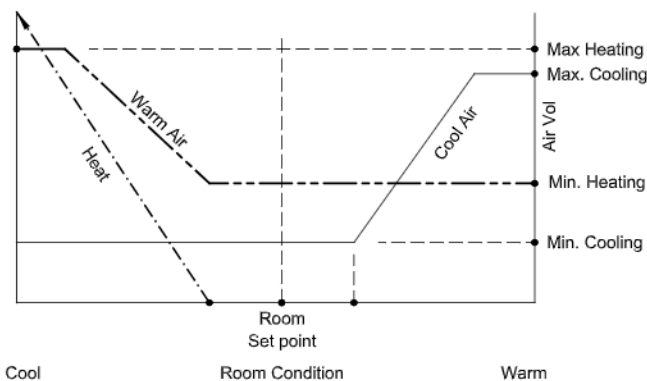

**Cool supply air:** On an increase in space temperature the controller regulates the actuator to open the VAV damper and increase the flow of cool air. On an increase of space temperature greater than the cooling proportional band, the airflow is maintained at its pre-selected maximum setting.

On a decrease in space temperature the controller regulates the actuator to close the VAV damper and reduce the flow of cool air. If the space temperature decreases to less than the cooling proportional band, the airflow is maintained at the pre-selected minimum setting.

**Warm supply air:** On a decrease in space temperature the controller regulates the actuator to open the VAV damper and increase the flow of warm air. On a decrease of space temperature greater than the heating proportional band, the airflow is maintained at its pre-selected maximum setting.

On an increase in space temperature the controller regulates the actuator to close the VAV damper and reduce the flow of warm air. If the space temperature increases above the heating proportional band, the airflow is maintained at the pre-selected minimum setting.

**Reheat Operation:** On a decrease in space temperature, the controller modulates the 0-10VDC output to increase heat proportionally to the room demand.

<b>PROJECT:</b>		<b>PRICE</b> <sup>®</sup>
<b>ENGINEER:</b>		
<b>CUSTOMER:</b>		KR/mm
<b>SUBMITTAL DATE:</b>		254834
<b>SPEC. SYMBOL:</b>		2012/11/13
		<b>SINGLE DUCT PAC</b> PRESSURE INDEPENDENT HEAT/COOL C/O OR COOLING WITH ANALOG ELECTRIC HEAT

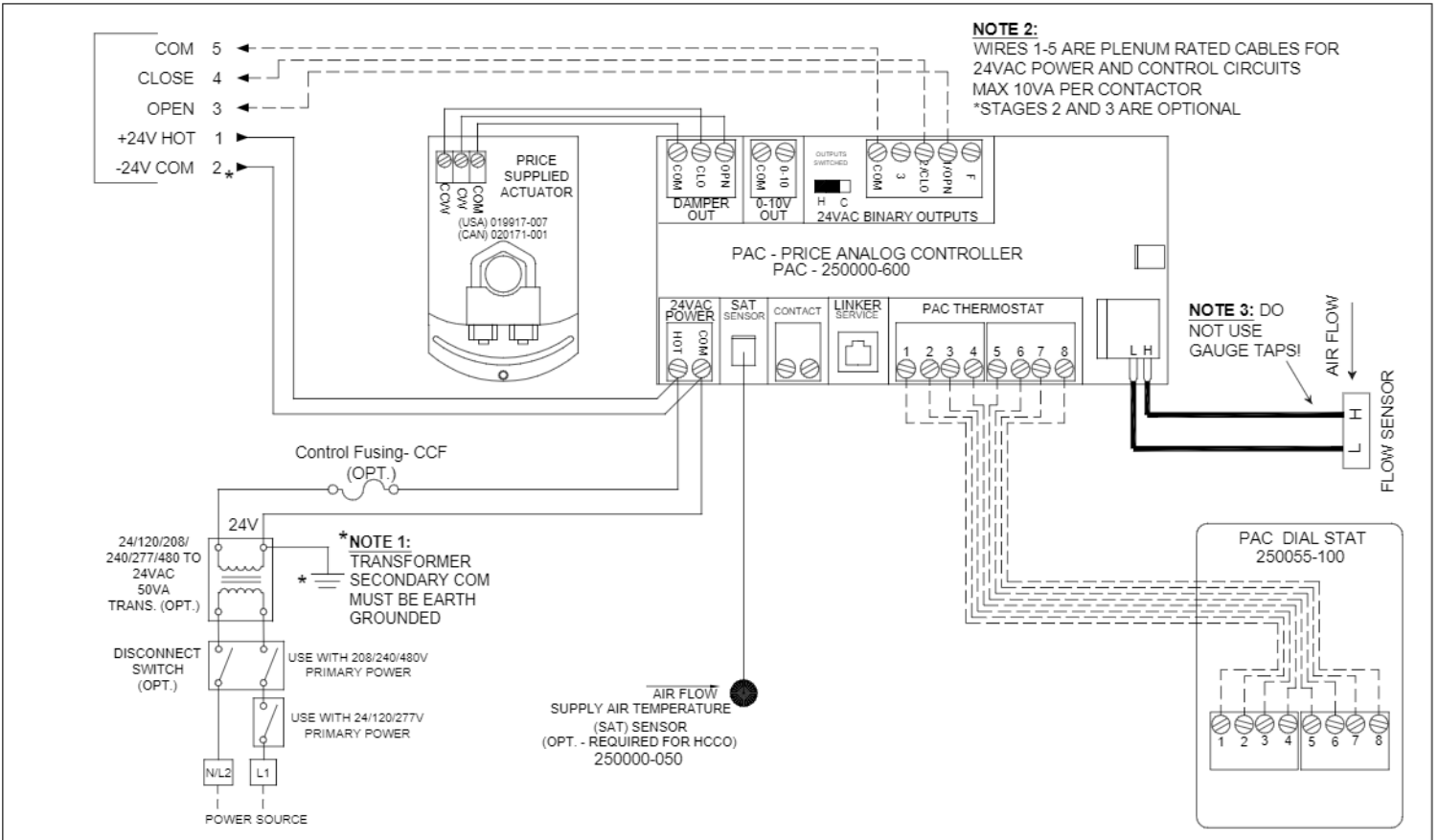

**Calibration note:** Suitable min and max heating flows must be selected in order to maintain flow through energized electric coils of at least 200 fpm and at least 70 cfm/kW throughout the entire operating range.

**LEGEND**

- FACTORY FLOW SENSOR TUBING
- FACTORY ELECTRICAL WIRING
- FIELD ELECTRICAL WIRING

**CONTROL GRAPH**

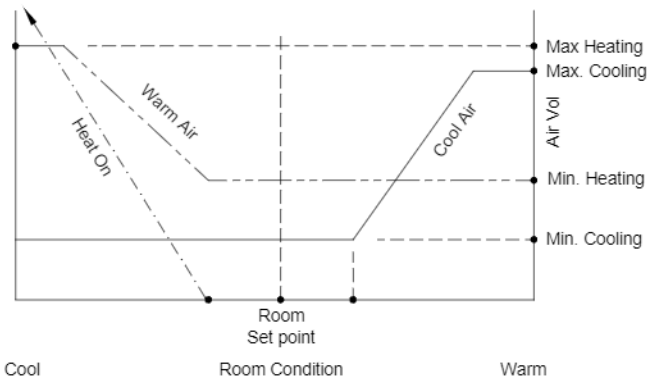

**Sequence of Operation -- Heat/cool changeover OR cooling With up to 3 stage binary reheat - Pressure Independent**

On power up the damper will calibrate closed for 2 minutes.

\*\*If no SAT sensor is present, the controller assumes Cool supply air at all times\*\*

**Cool supply air:** On an increase in space temperature the controller regulates the actuator to open the VAV damper and increase the flow of cool air. On an increase of space temperature greater than the cooling proportional band, the airflow is maintained at its pre-selected maximum setting.

On a decrease in space temperature the controller regulates the actuator to close the VAV damper and reduce the flow of cool air. If the space temperature decreases to less than the cooling proportional band, the airflow is maintained at the pre-selected minimum setting.

**Warm supply air:** On a decrease in space temperature the controller regulates the actuator to open the VAV damper and increase the flow of warm air. On a decrease of space temperature greater than the heating proportional band, the airflow is maintained at its pre-selected maximum setting.

On an increase in space temperature the controller regulates the actuator to close the VAV damper and reduce the flow of warm air. If the space temperature increases above the heating proportional band, the airflow is maintained at the pre-selected minimum setting.

**Reheat Operation:** On a decrease in space temperature into the heating proportional band, the HW valve is modulated to increase heat proportionally to room demand.

**PROJECT:**

**ENGINEER:**

**CUSTOMER:**

**SUBMITTAL DATE:**

**SPEC. SYMBOL:**



*GF mm*

264451

2014/03/14

**SINGLE DUCT  
PAC**  
PRESSURE INDEPENDENT  
HEAT/COOL C/O OR COOLING  
WITH FIELD WIRED TRI-STATE HW

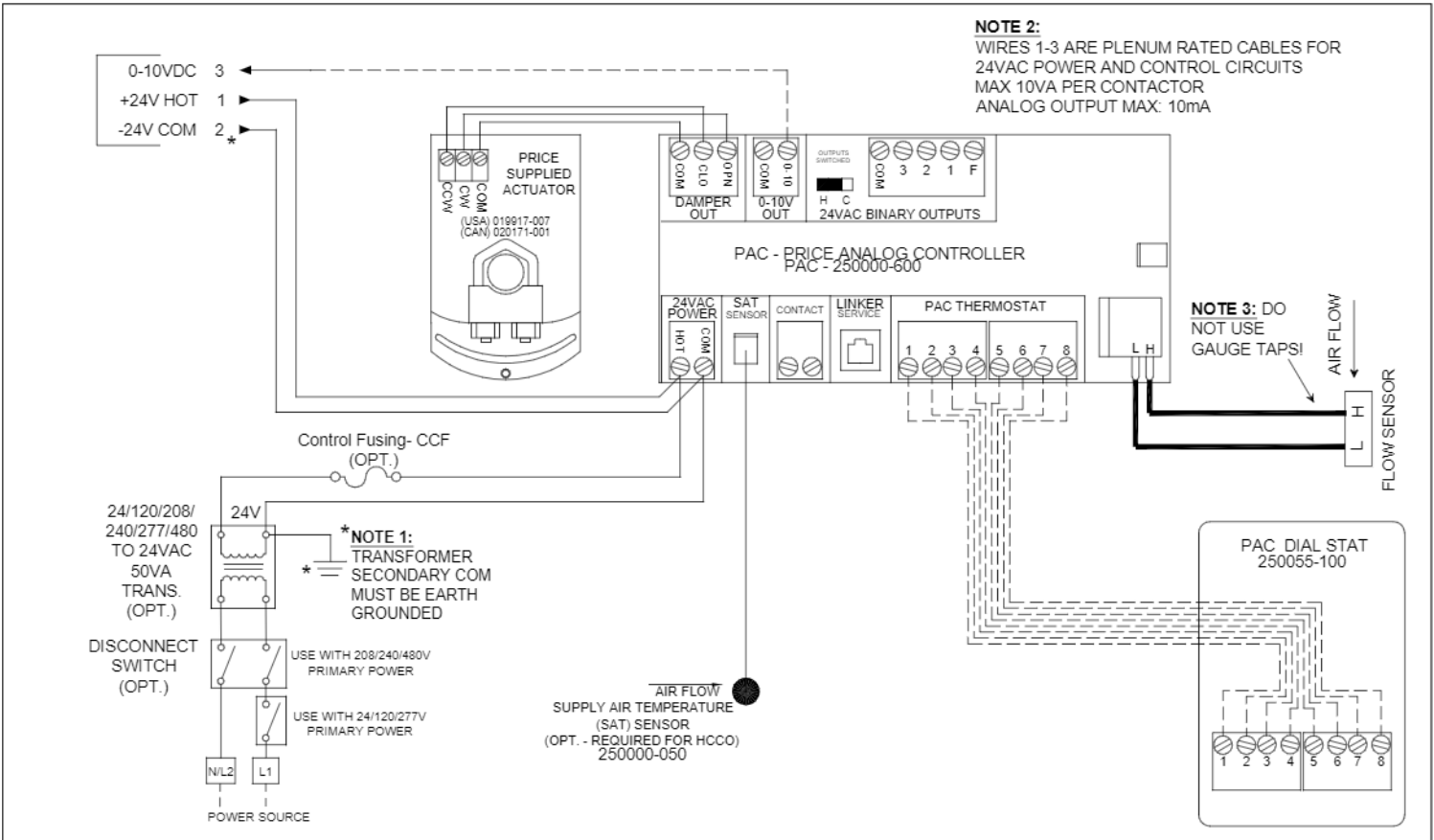

**Calibration note:** Suitable min and max heating flows must be selected in order to maintain flow through energized electric coils of at least 200 fpm and at least 70 cfm/kW throughout the entire operating range.

**Sequence of Operation -- Heat/cool changeover OR cooling With Analog modulating reheat - Pressure Independent**

On power up the damper will calibrate closed for 2 minutes.

\*\*If no SAT sensor is present, the controller assumes Cool supply air at all times\*\*

**Cool supply air:** On an increase in space temperature the controller regulates the actuator to open the VAV damper and increase the flow of cool air. On an increase of space temperature greater than the cooling proportional band, the airflow is maintained at its pre-selected maximum setting.

On a decrease in space temperature the controller regulates the actuator to close the VAV damper and reduce the flow of cool air. If the space temperature decreases to less than the cooling proportional band, the airflow is maintained at the pre-selected minimum setting.

**Warm supply air:** On a decrease in space temperature the controller regulates the actuator to open the VAV damper and increase the flow of warm air. On a decrease of space temperature greater than the heating proportional band, the airflow is maintained at its pre-selected maximum setting.

On an increase in space temperature the controller regulates the actuator to close the VAV damper and reduce the flow of warm air. If the space temperature increases above the heating proportional band, the airflow is maintained at the pre-selected minimum setting.

**Reheat Operation:** On a decrease in space temperature, the controller modulates the 0-10VDC output to increase heat proportionally to the room demand.

<b>PROJECT:</b>		<b>PRICE</b> <sup>®</sup>	
<b>ENGINEER:</b>		<i>G mm</i>	<b>SINGLE DUCT PAC</b>
<b>CUSTOMER:</b>			
<b>SUBMITTAL DATE:</b>	<b>SPEC. SYMBOL:</b>	2014/03/14	

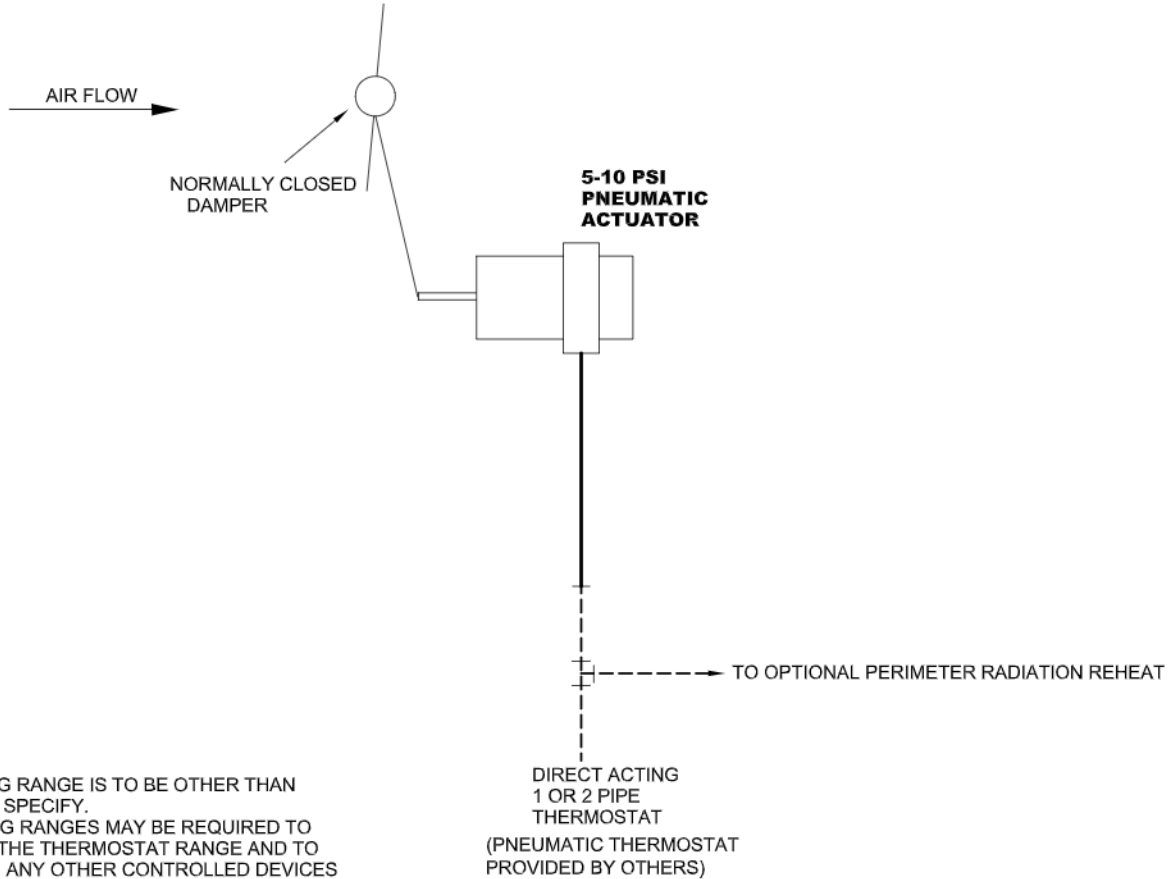

**NOTE:**  
IF MOTOR SPRING RANGE IS TO BE OTHER THAN 5-10 PSI, PLEASE SPECIFY.  
OPTIONAL SPRING RANGES MAY BE REQUIRED TO ACCOMMODATE THE THERMOSTAT RANGE AND TO SEQUENCE WITH ANY OTHER CONTROLLED DEVICES IN THE SYSTEM.

**LEGEND**

- FACTORY PNEUMATIC TUBING
- - - - - FIELD PNEUMATIC TUBING

**CONTROL GRAPH**

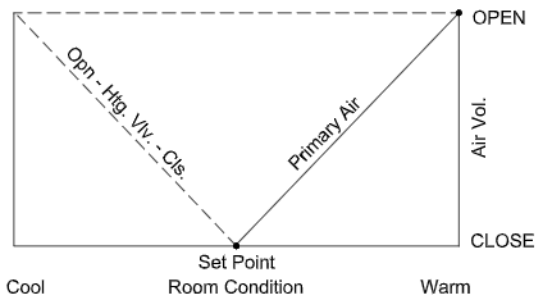

**Sequence of Operation -- Pressure dependent, variable volume, normally closed, direct acting cooling application.**

An increase in space temperature increases the thermostat output pressure. As the thermostat output increases from 5-10 psi or more, the VAV box damper is driven to the open position.

A decrease in space temperature decreases the thermostat output pressure. As the thermostat output decreases from to 10-5 psi or less, the VAV box damper is driven to the closed position.

**Normally Closed Damper:**

On failure of the main air supply the damper will fail to the closed position.

**PROJECT:**



**ENGINEER:**

*BTG/BC*

**CUSTOMER:**

231683

**SUBMITTAL DATE:**

**SPEC. SYMBOL:**

2011/11/07

SPV6 / RPV6 / LPV6  
5-10 PSI Actuator  
Cooling, Reheat Optional  
Variable Volume  
Pressure dependent  
D.A. T'Stat, N.C. Damper



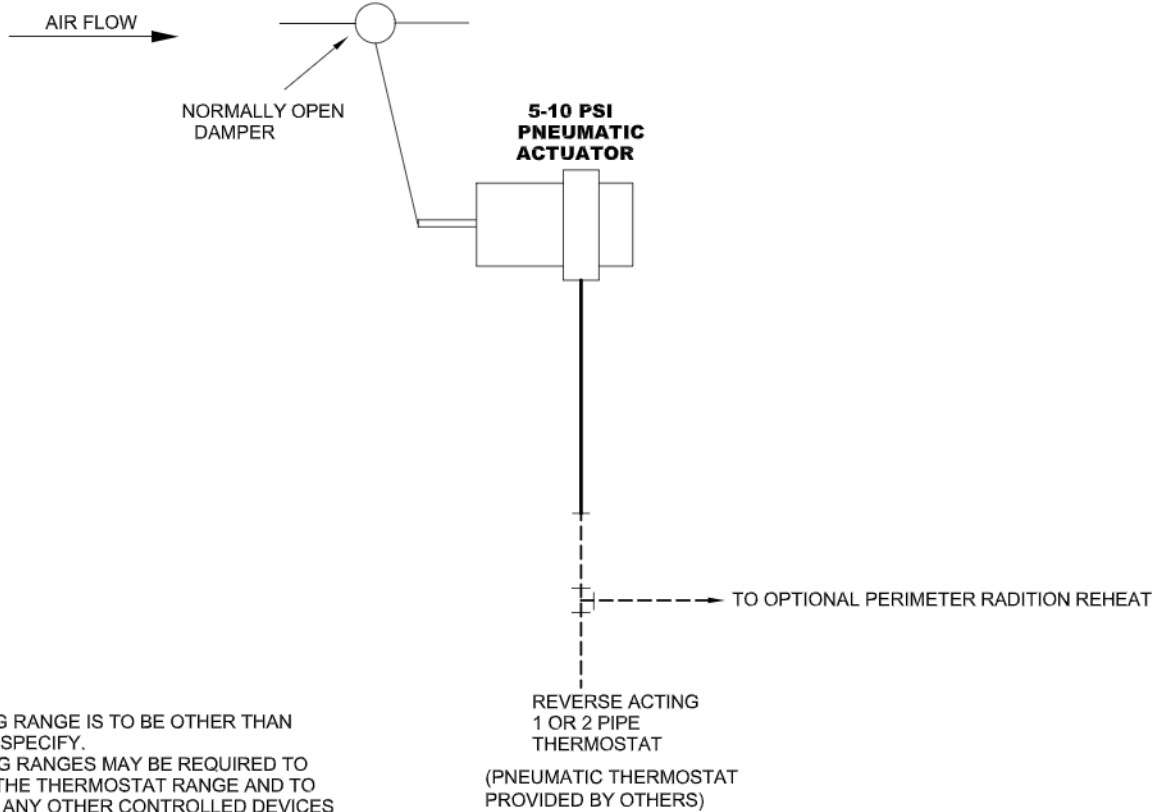

**NOTE:**

IF MOTOR SPRING RANGE IS TO BE OTHER THAN 5-10 PSI, PLEASE SPECIFY.  
OPTIONAL SPRING RANGES MAY BE REQUIRED TO ACCOMMODATE THE THERMOSTAT RANGE AND TO SEQUENCE WITH ANY OTHER CONTROLLED DEVICES IN THE SYSTEM.

**LEGEND**

- FACTORY PNEUMATIC TUBING
- FIELD PNEUMATIC TUBING

**CONTROL GRAPH**

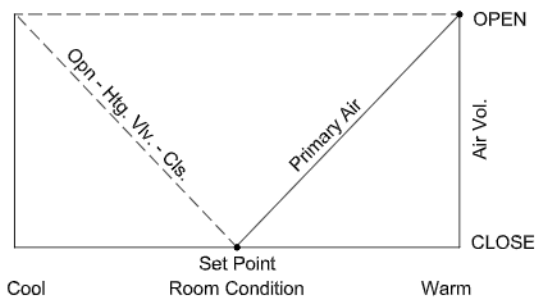

**Sequence of Operation -- Pressure dependent, variable volume, normally open, reverse acting cooling application.**

An increase in space temperature decreases the thermostat output pressure. As the thermostat output decreases from 10-5 psi or less, the VAV box damper is driven to the open position.

A decrease in space temperature increases the thermostat output pressure. As the thermostat output increases from to 5-10 psi or more, the VAV box damper is driven to the closed position.

**Normally Open Damper:**

On failure of the main air supply the damper will fail to the open position.

**PROJECT:**



**ENGINEER:**

*BTG/BC*

**CUSTOMER:**

231684

**SUBMITTAL DATE:**

**SPEC. SYMBOL:**

2011/11/07

SPV6 / RPV6 / LPV6  
5-10 PSI Actuator  
Cooling, Reheat Optional  
Variable Volume  
Pressure dependent  
R.A. T'Stat, N.O. Damper

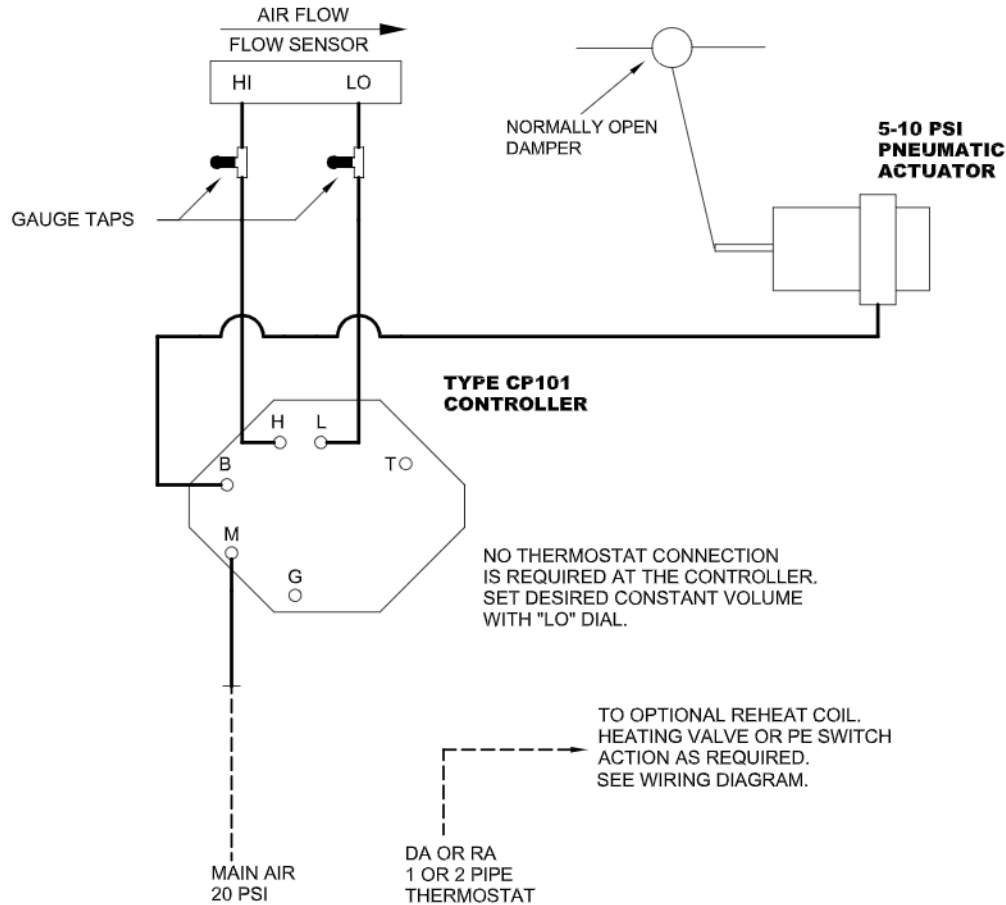

**NOTE:**

1) TOTAL AIR CONSUMPTION 0.017 SCFM.

**LEGEND**

- FACTORY PNEUMATIC TUBING
- FIELD PNEUMATIC TUBING

**CONTROL GRAPH**

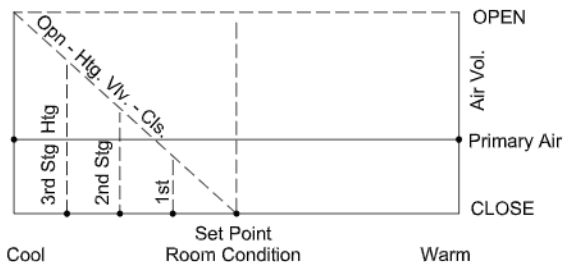

**Sequence of Operation -- Pressure independent, constant volume, normally open, direct acting cooling with optional reheat.**

The controller will maintain the preselected flow setting. It will modulate the damper based on changes in the duct pressure to maintain a constant air flow.

The thermostat may control optional reheat coils.

**Normally Open Damper:**

On failure of the main air supply the damper will fail to the open position.

**PROJECT:**



**ENGINEER:**

*BJH/BC*

**CUSTOMER:**

231687

**SUBMITTAL DATE:**

**SPEC. SYMBOL:**

2011/11/07

SPV8 / RPV8 / LPV8  
Kreuter CP101  
Clg., Reheat Optional  
Constant Volume  
Pressure Independent  
D.A. Controller, N.O. Damper

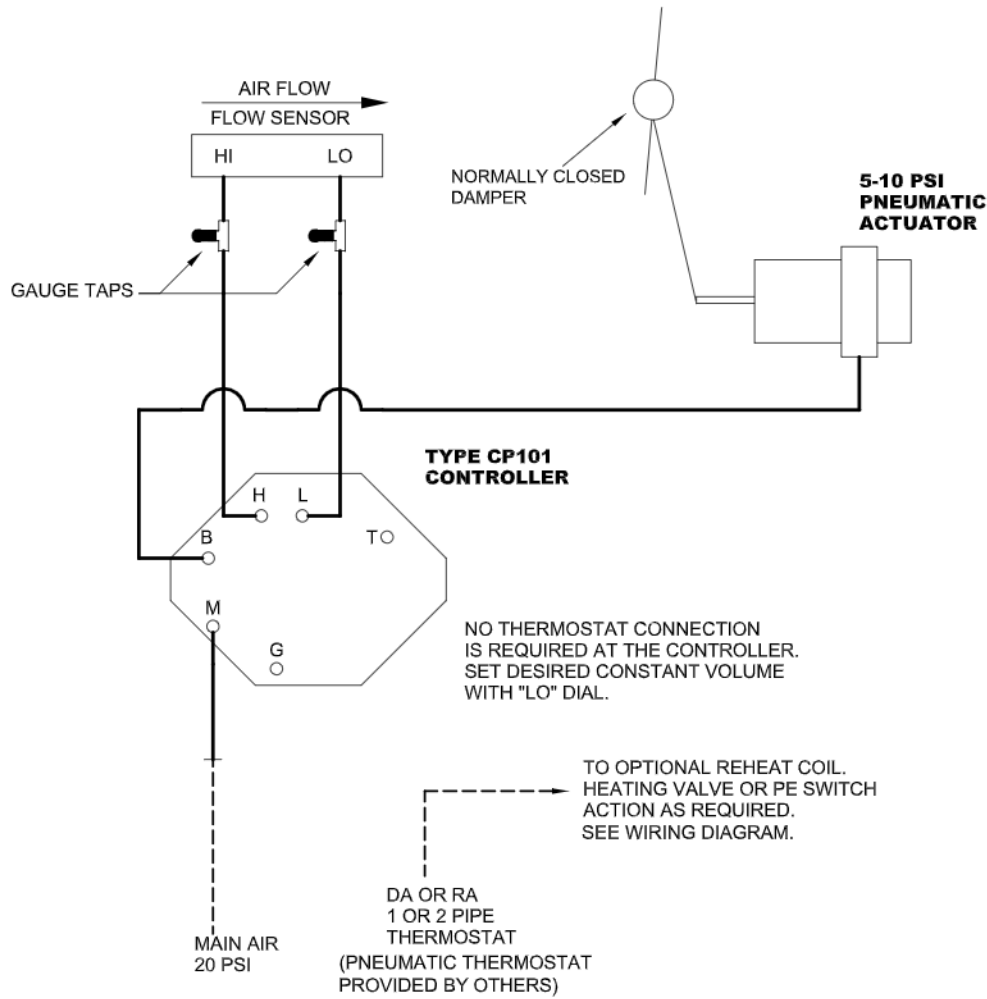

NO THERMOSTAT CONNECTION IS REQUIRED AT THE CONTROLLER. SET DESIRED CONSTANT VOLUME WITH "LO" DIAL.

TO OPTIONAL REHEAT COIL, HEATING VALVE OR PE SWITCH ACTION AS REQUIRED. SEE WIRING DIAGRAM.

DA OR RA  
1 OR 2 PIPE  
THERMOSTAT  
(PNEUMATIC THERMOSTAT PROVIDED BY OTHERS)

**NOTE:**

1) TOTAL AIR CONSUMPTION 0.017 SCFM.

**LEGEND**

- FACTORY PNEUMATIC TUBING
- FIELD PNEUMATIC TUBING

**CONTROL GRAPH**

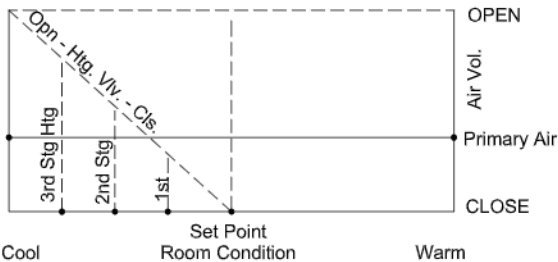

**Sequence of Operation -- Pressure independent, constant volume, normally closed, direct acting cooling with optional reheat.**

The controller will maintain the preselected flow setting. It will modulate the damper based on changes in the duct pressure to maintain a constant air flow.

The thermostat may control optional reheat coils.

**Normally Closed Damper:**

On failure of the main air supply the damper will fail to the closed position.

**PROJECT:**



**ENGINEER:**

*BTG/BC*

**CUSTOMER:**

231688

**SUBMITTAL DATE:**

**SPEC. SYMBOL:**

2011/11/07

SPV8 / RPV8 / LPV8  
Kreuter CP101  
Clg., HW Reheat Optional  
Constant Volume  
Pressure Independent  
D.A. Controller, N.C. Damper

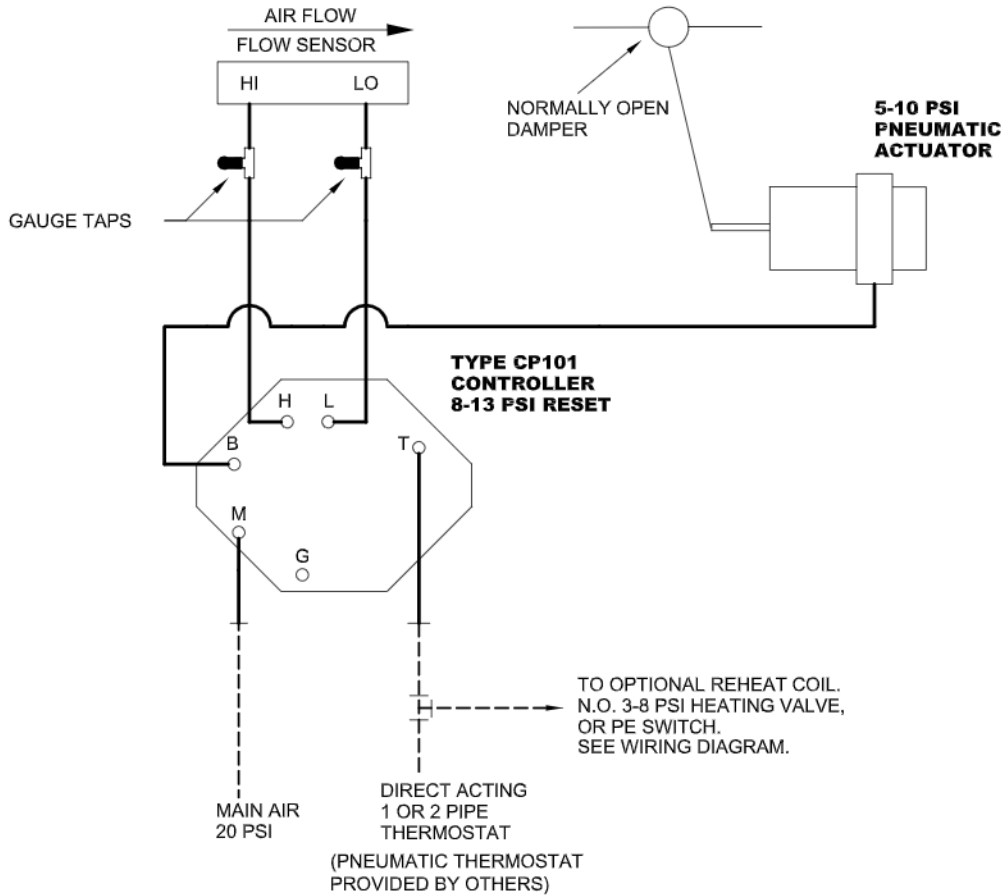

**NOTE:**

1) TOTAL AIR CONSUMPTION 0.017 SCFM.

**LEGEND**

- FACTORY PNEUMATIC TUBING
- FIELD PNEUMATIC TUBING

**CONTROL GRAPH**

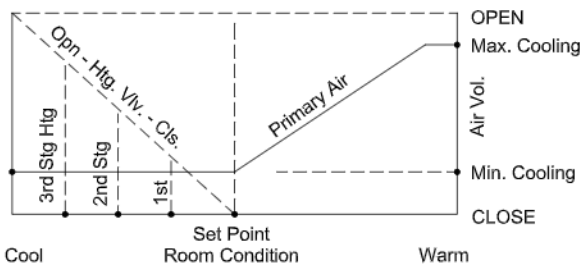

**Sequence of Operation -- Pressure independent, variable volume, normally open, direct acting cooling application, with optional reheat.**

An increase in space temperature increases the thermostat output pressure. When the thermostat output increases to 13 psi or more, the VAV box damper is maintained at the preselected maximum flow setting. A decrease in space temperature decreases the thermostat output pressure. When the thermostat output decreases to 8 psi or less, the VAV damper is maintained at the preselected minimum flow setting. At thermostat output pressures between 8 & 13 psi the VAV damper modulates between minimum & maximum flow. At thermostat output pressures below 8 psi the minimum flow setting is maintained, and the thermostat may control optional reheat coils. Airflow is held constant at any given thermostat output pressure regardless of changes in inlet duct static pressure.

**Normally Open Damper:**

On failure of the main air supply the damper will fail to the open position.

**PROJECT:**



**ENGINEER:**

*BTH/BC*

**CUSTOMER:**

231691

**SUBMITTAL DATE:**

**SPEC. SYMBOL:**

2011/11/07

SPV8 / RPV8 / LPV8  
Kreuter CP101  
Clg., Reheat Optional  
Variable Volume  
Pressure Independent  
D.A. T'Stat, N.O. Damper



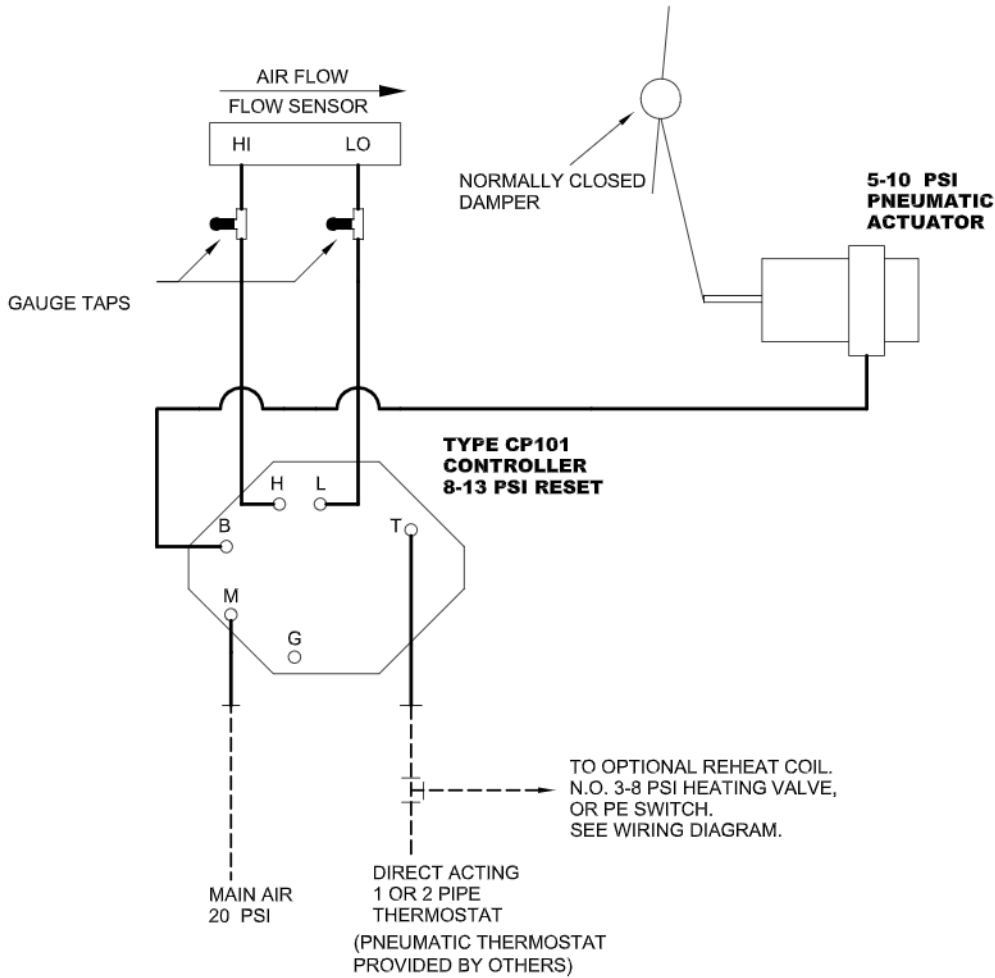

**NOTE:**

1) TOTAL AIR CONSUMPTION 0.017 SCFM.

**LEGEND**

- FACTORY PNEUMATIC TUBING
- - - - - FIELD PNEUMATIC TUBING

**CONTROL GRAPH**

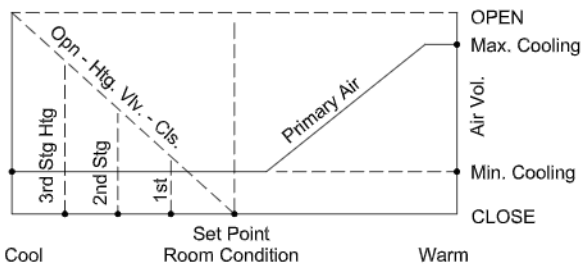

**Sequence of Operation -- Pressure independent, variable volume, normally closed, direct acting cooling application, with optional reheat.**

An increase in space temperature increases the thermostat output pressure. When the thermostat output increases to 13 psi or more, the VAV box damper is maintained at the preselected maximum flow setting. A decrease in space temperature decreases the thermostat output pressure. When the thermostat output decreases to 8 psi or less, the VAV box damper is maintained at the preselected minimum flow setting. At thermostat output pressures between 8 & 13 psi the VAV damper modulates between minimum & maximum flow. At thermostat output pressures below 8 psi the minimum flow setting is maintained, and the thermostat may control optional reheat coils. Airflow is held constant at any given thermostat output pressure regardless of changes in inlet duct static pressure.

**Normally Closed Damper:**

On failure of the main air supply the damper will fail to the closed position.

**PROJECT:**



**ENGINEER:**

*BJH/BC*

**CUSTOMER:**

231692

**SUBMITTAL DATE:**

**SPEC. SYMBOL:**

2011/11/07

SPV8 / RPV8 / LPV8  
Kreuter CP101  
Clg., Reheat Optional  
Variable Volume  
Pressure Independent  
D.A. T'Stat, N.C. Damper

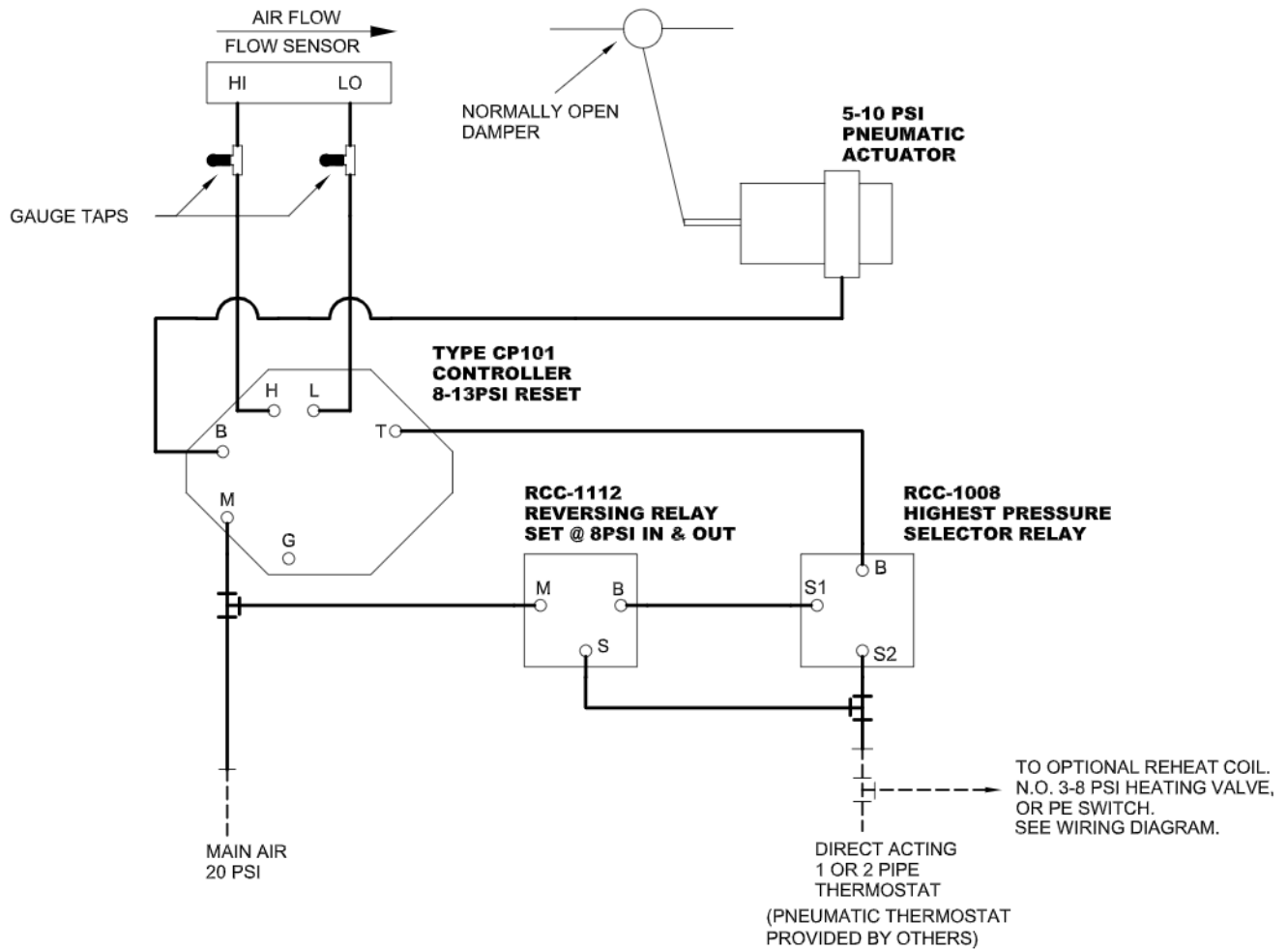

**NOTE:**

1) TOTAL AIR CONSUMPTION 0.027 SCFM.

**LEGEND**

- FACTORY PNEUMATIC TUBING
- - - - - FIELD PNEUMATIC TUBING

**CONTROL GRAPH**

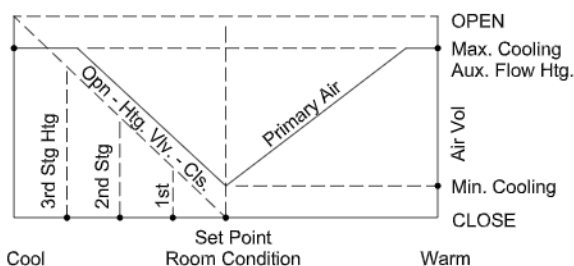

**Sequence of Operation -- Pressure independent, variable volume, normally open, direct acting cooling with auxiliary flow on heating.**

An increase in space temperature increases the thermostat output pressure. When the thermostat output increases to 13 psi or more, the VAV box damper is maintained at the pre-selected maximum flow setting. A decrease in space temperature decreases the thermostat output pressure. When the thermostat output decreases to 8 psi, the VAV box damper is maintained at the pre-selected minimum flow setting. As thermostat output pressure continues to decrease between 8 & 3 psi the VAV damper modulates to the auxiliary flow setting. At thermostat output pressures below 8 psi the thermostat may also control optional reheat coils. Airflow is held constant at any given thermostat output pressure regardless of changes in inlet duct static pressure.

**Normally Open Damper:**

On failure of the main air supply the damper will fail to the open position.

**PROJECT:**



**ENGINEER:**

*BTG/BC*

**CUSTOMER:**

231693

**SUBMITTAL DATE:**

**SPEC. SYMBOL:**

2011/11/07

SPV8 / RPV8 / LPV8  
Kreuter CP101  
Clg., Reheat Optional  
Var. Vol. Clg. - Aux. Flow Htg.  
Pressure Independent  
D.A. T'Stat, N.O. Damper

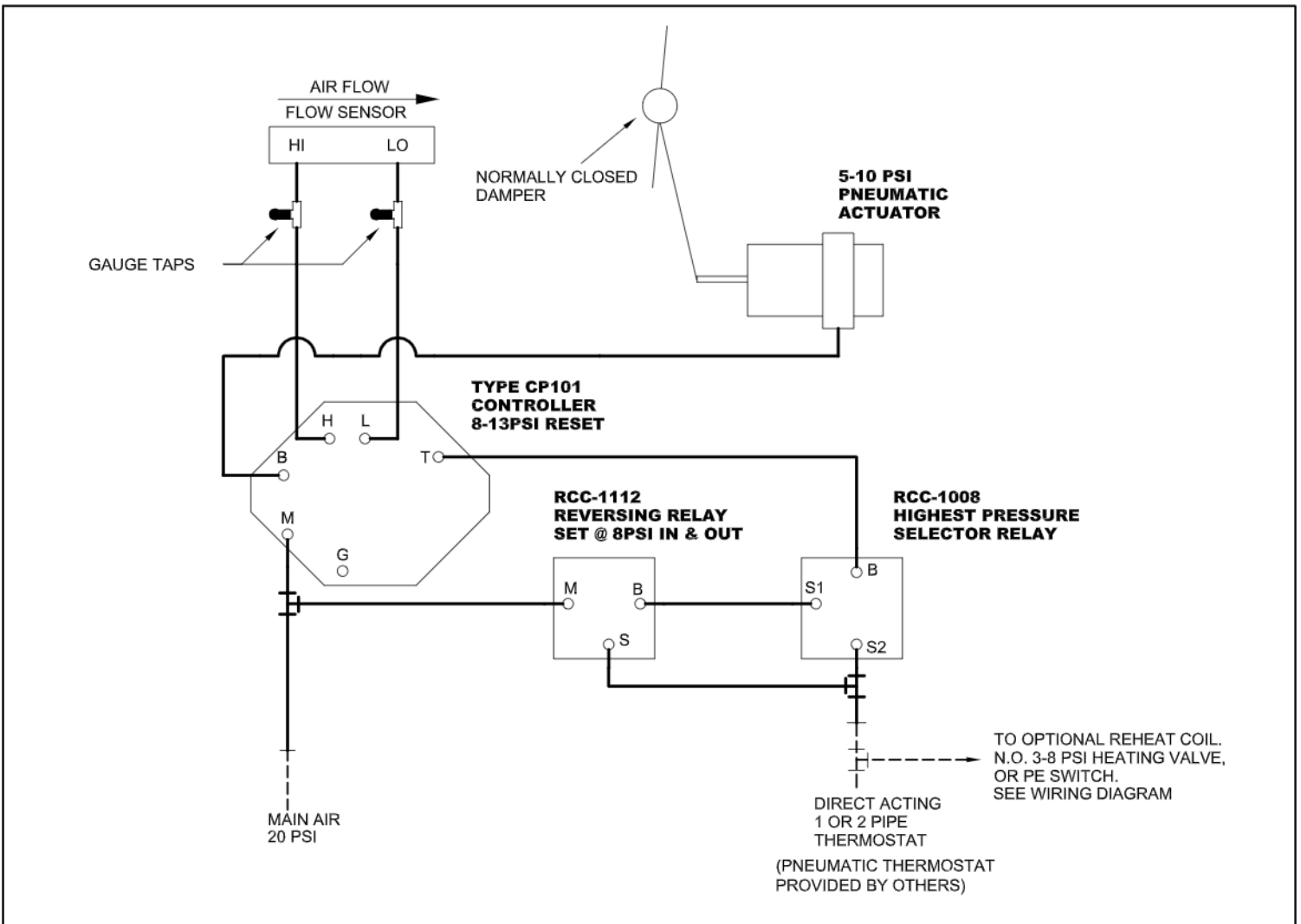

**NOTE:**

1) TOTAL AIR CONSUMPTION 0.027 SCFM.

**LEGEND**

- FACTORY PNEUMATIC TUBING
- - - - - FIELD PNEUMATIC TUBING

**CONTROL GRAPH**

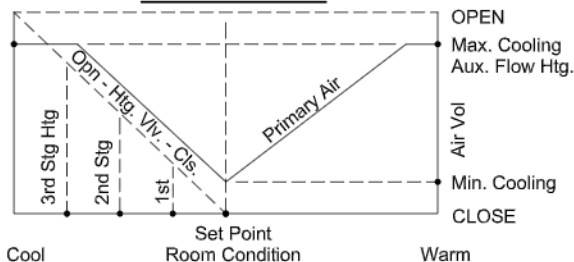

**Sequence of Operation -- Pressure independent, variable volume, normally closed, direct acting cooling with auxiliary flow on heating.**

An increase in space temperature increases the thermostat output pressure. When the thermostat output increases to 13 psi or more, the VAV box damper is maintained at the pre-selected maximum flow setting. A decrease in space temperature decreases the thermostat output pressure. When the thermostat output decreases to 8 psi, the VAV box damper is maintained at the pre-selected minimum flow setting. As thermostat output pressure continues to decrease between 8 & 3 psi the VAV damper modulates to the auxiliary heating flow setting. At thermostat output pressures below 8 psi the thermostat may also control optional reheat coils. Airflow is held constant at any given thermostat output pressure regardless of changes in inlet duct static pressure.

**Normally Closed Damper:**

On failure of the main air supply the damper will fail to the closed position.

**PROJECT:**



**ENGINEER:**

*BTG/BC*

**CUSTOMER:**

231694

**SUBMITTAL DATE:**

**SPEC. SYMBOL:**

2011/11/07

SPV8 / RPV8 / LPV8  
Kreuter CP101  
Clg., Reheat Optional  
Var. Vol. Clg. - Aux. Flow Htg.  
Pressure Independent  
D.A. T'Stat, N.C. Damper

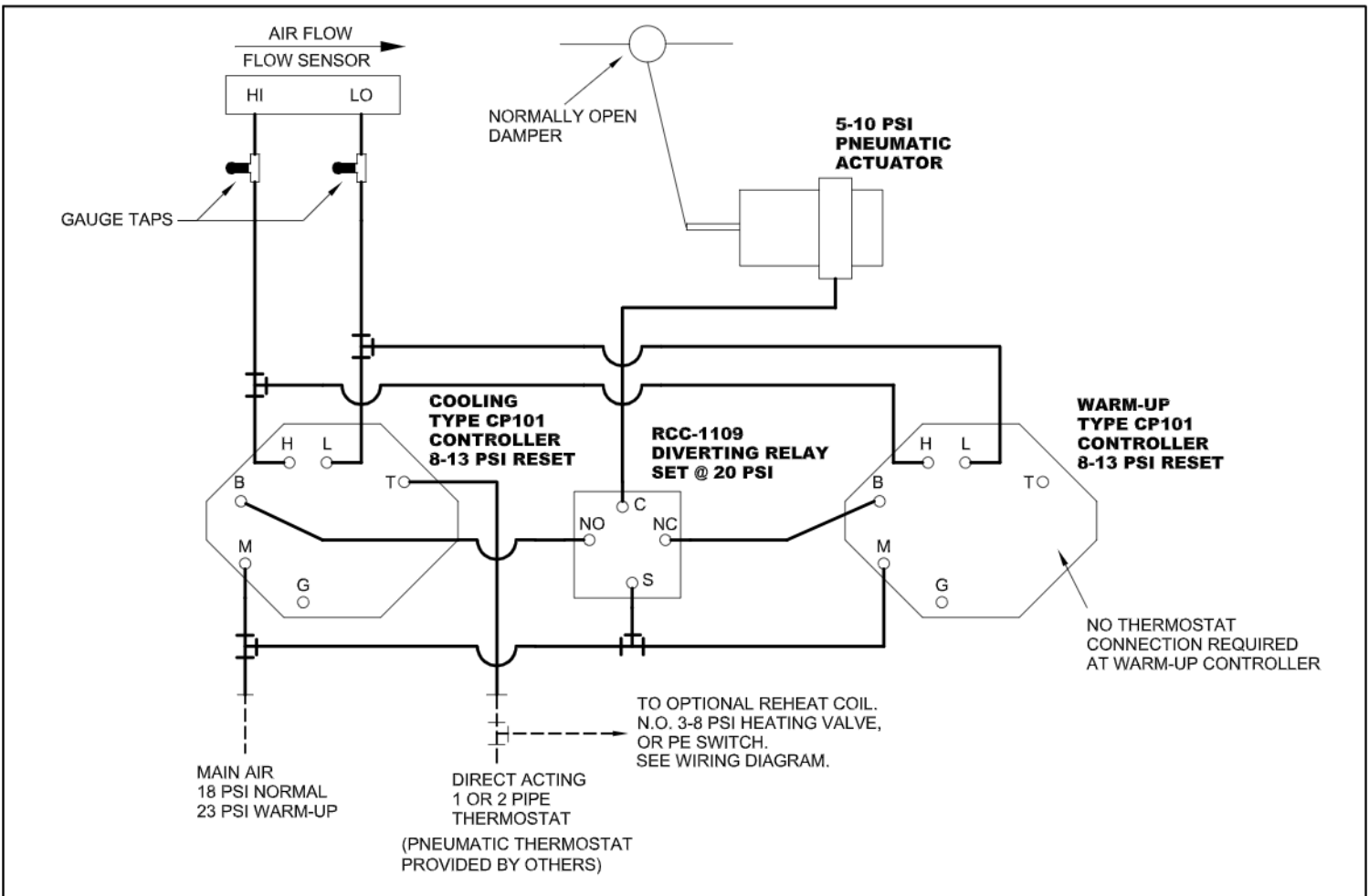

**NOTE:**

1) TOTAL AIR CONSUMPTION 0.034 SCFM.

**LEGEND**

- FACTORY PNEUMATIC TUBING
- - - - - FIELD PNEUMATIC TUBING

**CONTROL GRAPH**

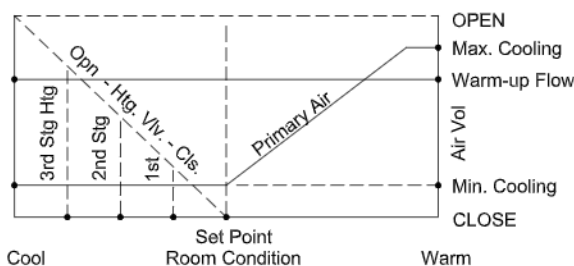

**Sequence of Operation -- Pressure independent, variable volume on cooling, normally open, direct acting, adjustable constant volume on warm-up application, and optional reheat.**

**Normal operation with main air pressure at 18 psi:** an increase in space temperature increases the thermostat output pressure. When the thermostat output increases to 13 psi or more, the VAV box damper is maintained at the preselected maximum flow setting.

A decrease in space temperature decreases the thermostat output pressure. When the thermostat output decreases to 8 psi, the VAV box damper is maintained at the preselected minimum flow setting.

As thermostat output pressure continues to decrease between 8 & 3 psi, the VAV damper is maintained at the preselected minimum setting.

At thermostat output pressures below 8 p.s.i. the thermostat may also control optional reheat coils.

**Warm-up with main air pressure at 23 psi:** the VAV damper is opened to the preselected warm-up flow setting. Optional reheat coils operate in the normal manner.

Airflow is held constant at any given thermostat output pressure and in the warm-up mode, regardless of changes in inlet duct static pressure.

**Normally Open Damper:**

On failure of the main air supply the damper will fail to the open position.

**PROJECT:**

**ENGINEER:**

**CUSTOMER:**

**SUBMITTAL DATE:**

**SPEC. SYMBOL:**



*BTG/BC*

231699

2011/11/07

SPV8 / RPV8 / LPV8  
Kreuter CP101  
Clg., Reheat Optional  
Var. Vol. Clg. - Adj. Warm-Up  
Pressure Independent  
D.A. T'Stat, N.O. Damper

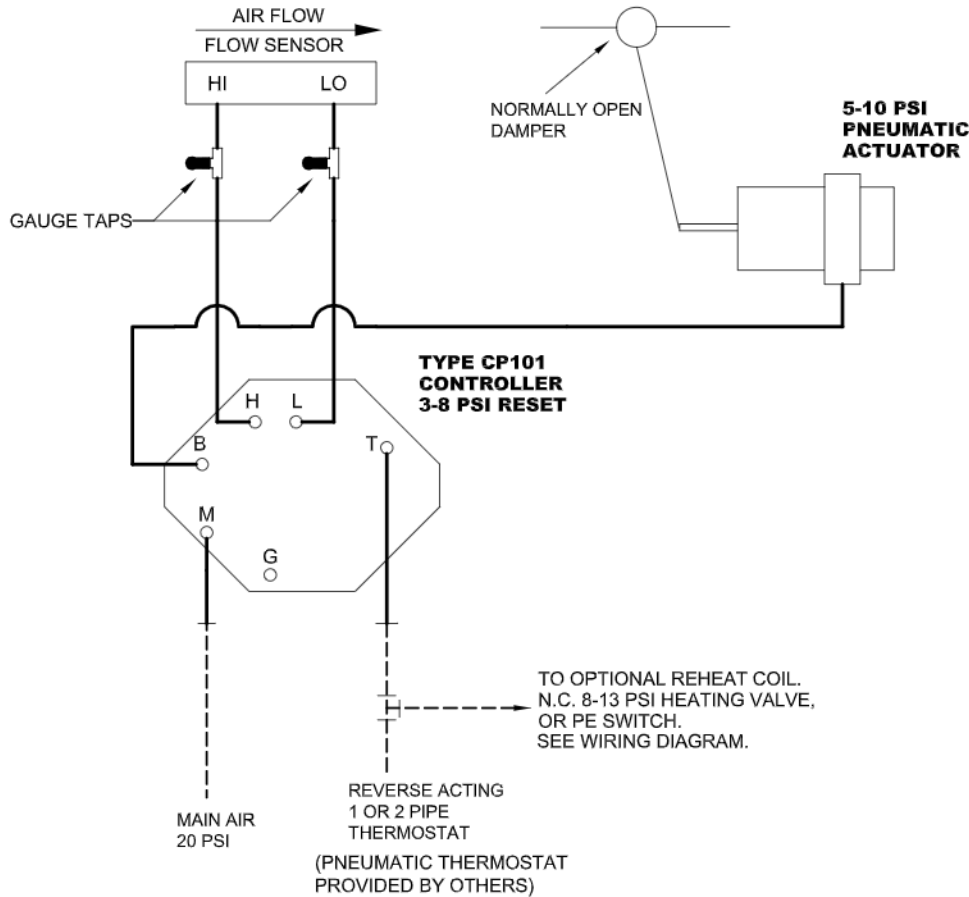

**NOTE:**

1) TOTAL AIR CONSUMPTION 0.017 SCFM.

**LEGEND**

- FACTORY PNEUMATIC TUBING
- FIELD PNEUMATIC TUBING

**CONTROL GRAPH**

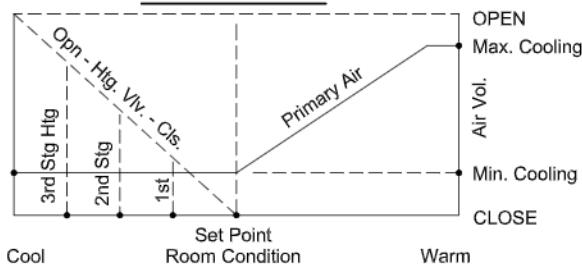

**Sequence of Operation -- Pressure independent, variable volume, normally open, reverse acting cooling application, with optional reheat.**

An increase in space temperature decreases the thermostat output pressure. When the thermostat output decreases to 3 psi or less, the VAV box damper is maintained at the pre-selected maximum flow setting.

A decrease in space temperature increases the thermostat output pressure. When the thermostat output increases to 8 psi or more, the VAV box damper is maintained at the pre-selected minimum flow setting.

At thermostat output pressures between 3 & 8 psi the VAV damper modulates between minimum & maximum flow.

At thermostat output pressures above 8 psi the minimum flow setting is maintained, and the thermostat may control optional reheat coils.

Airflow is held constant at any given thermostat output pressure regardless of changes in inlet duct static pressure.

**Normally Open Damper:**

On failure of the main air supply the damper will fail to the open position.

**PROJECT:**



**ENGINEER:**

*BTH/BC*

**CUSTOMER:**

231701

**SUBMITTAL DATE:**

**SPEC. SYMBOL:**

2011/11/07

SPV8 / RPV8 / LPV8  
Kreuter CP101  
Clg., Reheat Optional  
Variable Volume  
Pressure Independent  
R.A. T'Stat, N.O. Damper



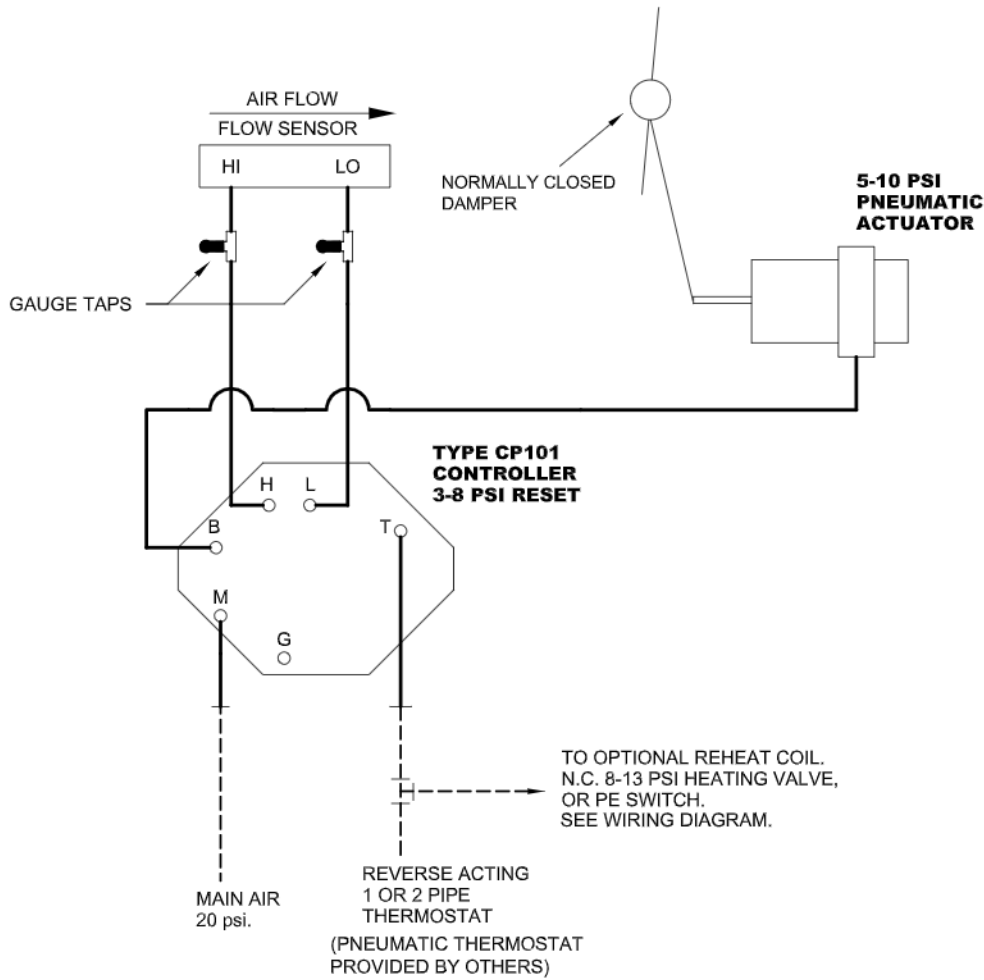

**NOTE:**

1) TOTAL AIR CONSUMPTION 0.017 SCFM.

**LEGEND**

- FACTORY PNEUMATIC TUBING
- FIELD PNEUMATIC TUBING

**CONTROL GRAPH**

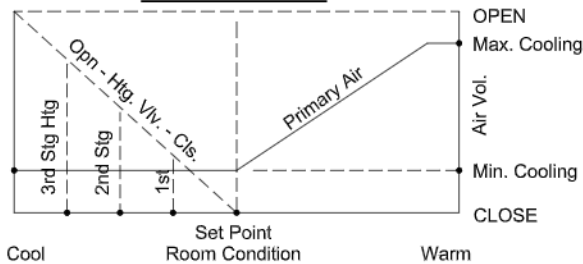

**Sequence of Operation -- Pressure independent, variable volume, normally closed, reverse acting cooling application with optional reheat.**

An increase in space temperature decreases the thermostat output pressure. When the thermostat output decreases to 3 psi or less, the VAV box damper is maintained at the preselected maximum flow setting. A decrease in space temperature increases the thermostat output pressure. When the thermostat output increases to 8 psi. or more, the VAV box damper is maintained at the preselected minimum flow setting. At thermostat output pressures between 3 & 8 psi. the VAV damper modulates between minimum & maximum flow settings. At thermostat output pressures above 8 psi. the minimum flow setting is maintained, and the thermostat may control optional reheat coils. Airflow is held constant at any given thermostat output pressure regardless of changes in inlet duct static pressure.

**Normally Closed Damper:**

On failure of the main air supply the damper will fail to the closed position.

**PROJECT:**



**ENGINEER:**

*BTG/BL*

**CUSTOMER:**

231702

**SUBMITTAL DATE:**

**SPEC. SYMBOL:**

2011/11/07

SPV8 / RPV8 / LPV8  
Kreuter CP101  
Clg., Reheat Optional  
Variable Volume  
Pressure Independent  
R.A. T'Stat, N.C. Damper