

# Engineering Guide Underfloor Products

Please refer to the **Price Engineer's HVAC Handbook**  
for more information on Underfloor Air Distribution.

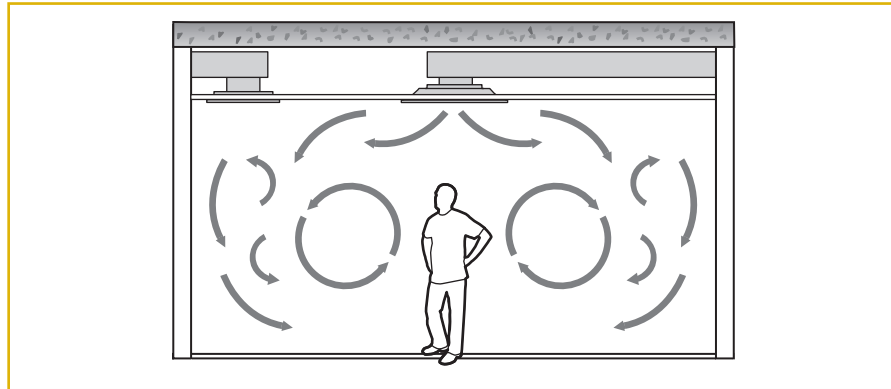
## Introduction

Underfloor air distribution (UFAD) systems are a hybrid of displacement and mixing ventilation systems, and are specifically designed to mix the occupied zone—the first 6 ft [1.8 m] of the room—allowing air to stratify above this point. UFAD systems create a general upward flow of air in the space and, like displacement ventilation, allow the effective removal of heat, pollutants and odors. Underfloor air distribution systems are often able to manage higher loads than displacement ventilation while maintaining thermal comfort and offering an increased level of occupant control.

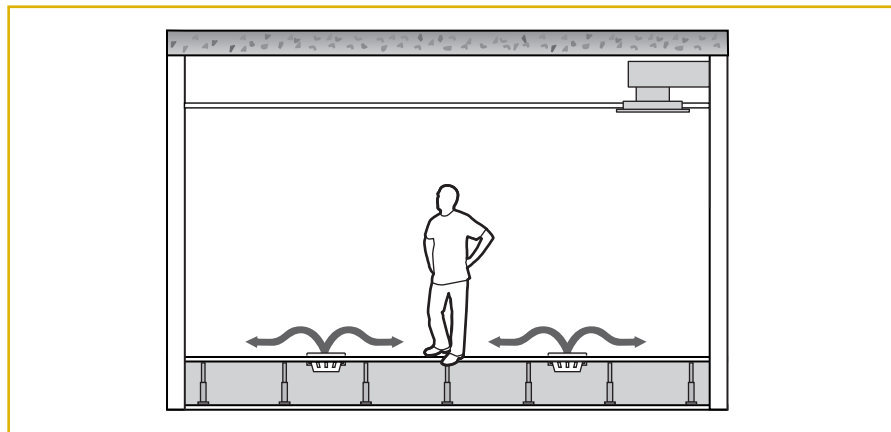
Air flow in ventilated spaces generally can be classified into two different types: mixing (or dilution) ventilation and displacement ventilation. Mixing ventilation systems, as shown in **Figure 1**, generally supply air in a manner such that the entire room air is fully mixed. The cool supply air exits the outlet at high velocity, inducing room air to provide mixing and temperature equalization. For more information, see Chapter 9—Introduction to Mixing Ventilation of the Price Engineer's HVAC Handbook. Since the entire room is fully mixed, temperature variations are small while the contaminant concentration is uniform throughout the entire room.

As described in Chapter 15—Fundamentals of Displacement Ventilation from the Price Engineer's HVAC Handbook, displacement ventilation systems (**Figure 2**) introduce air at low velocities, which causes minimal induction and mixing. The system utilizes buoyancy forces (generated by heat sources such as people, lighting, computers, electrical equipment, etc.) in a room to move contaminants and heat from the occupied zone. By doing so, the air quality in the occupied zone is generally superior to that achieved with mixing ventilation.

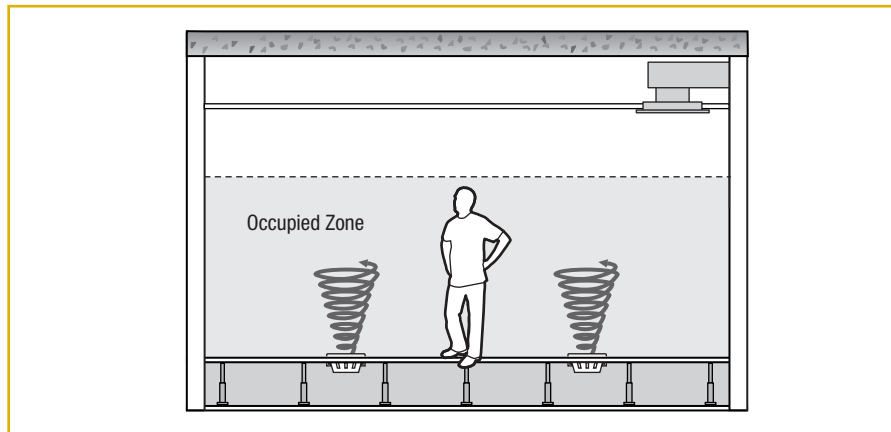
Underfloor air distribution, UFAD, (**Figure 3**) differs from displacement ventilation systems primarily in the way the air is delivered to the space. The air is supplied at a higher velocity through smaller sized outlets, typically mixing the occupied zone (6 ft [1.8 m] above the floor) and allowing air to stratify above this point. Additionally, the volume and/or direction of the local air supply are usually under the control of the occupants, allowing the comfort conditions to be optimized. The UFAD system creates a general upward flow of air in the space which, working with the natural buoyancy of room air warmed by the heat loads, allows the effective removal of heat, pollutants and odors. Together with the room air, they are removed from the space through the building exhaust or return air system located in the ceiling or at a high level.



**Figure 1:** Mixing (dilution) ventilation



**Figure 2:** Displacement ventilation



**Figure 3:** Underfloor air distribution

The diffusers are installed in the floor tiles of the conventional raised floor system. If the room layout is changed, the floor tiles are interchangeable and air distribution can be customized as required.

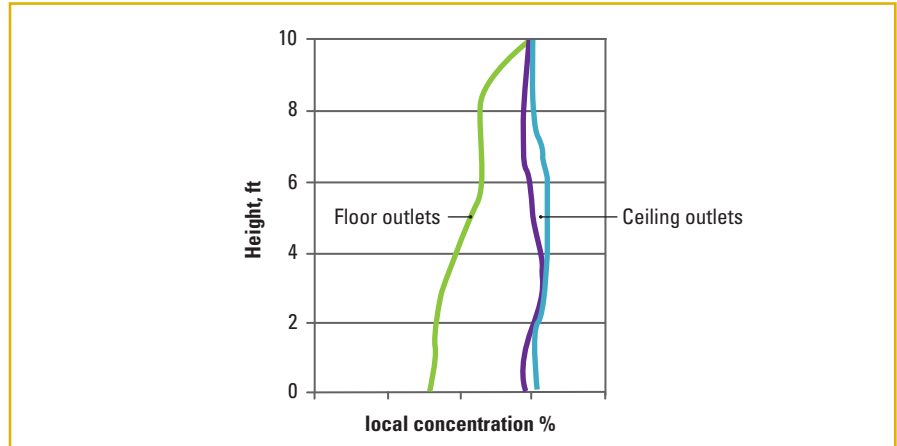
Since the conditioned air is supplied directly into the occupied zone, supply air

temperature must be higher than mixing systems (usually 63 °F [17 °C] or higher) to avoid a cold thermal sensation due to the low surface temperature of the raised floor. By introducing the air at moderately cool supply air temperatures and rapidly mixing with room air, a high level of thermal comfort can be achieved.

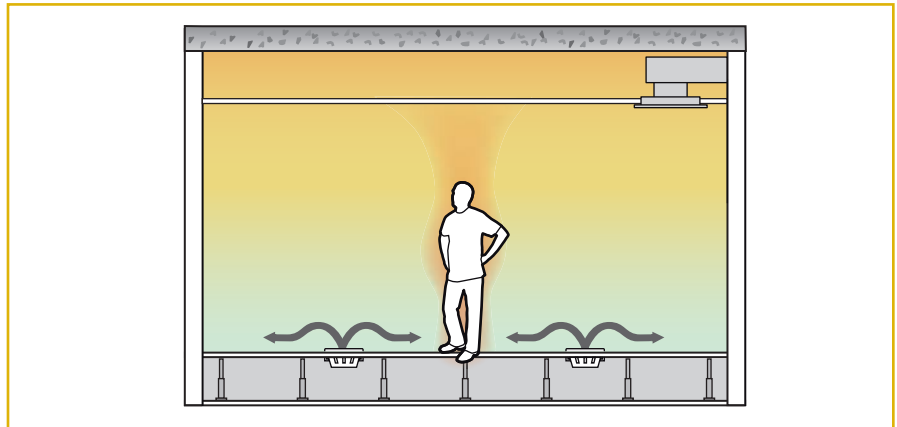
## Basics of Underfloor Air Distribution

Underfloor air distribution offers many benefits for the owner, such as:

- 1. Flexibility:** UFAD and raised flooring has been used for decades in computer rooms because of the flexibility they provide. The same benefits are captured with use in office spaces and call centers. Today's workplace typically has an abundance of cubicles and a proclivity for change. UFAD is ideally suited to this type of environment, as office reconfiguration is made easier with the ability to move floor tiles with diffusers to another location simply by rearranging the tiles. Since there is little or no ductwork involved, this can be done quickly and efficiently by building maintenance personnel. Furthermore, the proximity of diffusers to occupants allows easy adjustment for individual users.
- 2. Reduced cost of churn:** describes the total number of moves made within a 12 month period divided by the number of occupants in the same period (IFMA, 2002). A 1997 survey by International Facilities Management Association (IFMA) determined that, on average, 44% of occupants move per year. There is a cost associated with these moves, including modifications to HVAC, cubicles and furniture to accommodate these office renovations. HVAC changes with an overhead system are time-consuming and costly, as ductwork must be moved and work done over the ceiling. IFMA estimates the average cost of a move in a government setting is \$1,340 USD, per occupant; however, with a UFAD system that figure could be reduced by more than half. With a UFAD system there is little or no ductwork to move, and changes are made simply by unscrewing and moving the floor tile and diffuser to another location and screwing it in. The ability for data and power cabling to be located in the floor further adds to the cost savings associated with churn.
- 3. Indoor Air Quality:** is an important issue in today's society. A better indoor environment has been linked to increased productivity and fewer sick days by employees. UFAD is a major contributor in creating a better air quality environment. **Figure 4** shows that the concentration of air pollutants in the occupied zone is lower with air distribution outlets located in the floor vs. in the ceiling.



**Figure 4:** Contaminant air distribution (source: Krantz Komponenten®)



**Figure 5:** Underfloor air distribution with displacement diffuser

### Typical Applications

UFAD is an effective method of obtaining good air quality and thermal comfort in the occupied space. Typical applications where UFAD has been successfully used are:

- Green buildings (LEED)
- Office buildings
- Television studios or similar areas with high heat loads that require quiet cooling of occupants at floor level
- Meeting rooms
- Conference rooms, theaters, auditoriums, or similar spaces with high ceilings
- Libraries
- Spaces with high occupancy and/or high churn rate
- Spaces with high electrical power and/or data density (ease of cable runs)

UFAD is usually a good choice in the following cases:

- Contaminants are warmer and/or lighter than the room air
- Supply air is colder than the room air
- Room heights are 9 ft [2.7 m] or more
- Low noise levels are desired
- The space has high churn rates and requires a lot of flexibility
- Raised floor systems are already in place for other purposes

UFAD is not a good choice in the following cases:

- Hospitals (patient and surgical spaces)
- Secure facilities (jail cells, etc.)
- Spaces which require wash-down for cleaning

## Basics of Underfloor Air Distribution

### Underfloor Air Distribution and Displacement Ventilation

Underfloor air distribution, in its most general form, is the delivery and distribution of supply air to an underfloor plenum or network of ductwork for the purpose of injecting supply air to a zone through the floor. At the point of injection from below the floor into the zone, the choice of diffuser is often the prevailing factor in determining what the air flow patterns will be in the zone. For example, choosing a floor diffuser that creates a low flow, horizontal displacement pattern, as shown in **Figure 5**, will result in characteristic displacement ventilation room air flow patterns. Contrast that with choosing a floor diffuser that creates a high induction turbulent or swirl pattern with a mostly vertical throw, as shown in **Figure 6**, which will allow mixing to take place in the occupied zone.

There are zones that are generally more suited to displacement ventilation including, but not limited to:

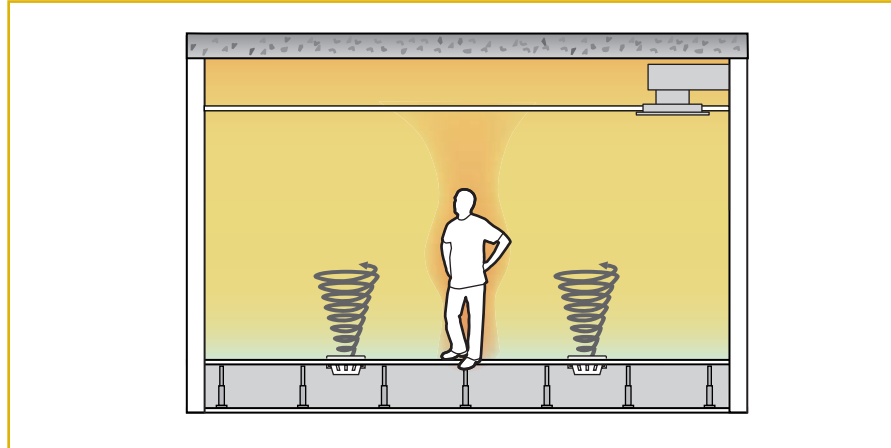
- Lobbies
- Gyms
- Cafeterias

A key advantage of using displacement ventilation in these spaces is that they use a similar supply air temperature as the spaces with UFAD. These two systems are very easily applied together. The choice of diffuser not only dictates the air flow rate and pattern in the zone, but can also affect the degree to which stratification takes place, the thermal comfort experienced by occupants, the ventilation effectiveness of the room, and all other characteristics of stratified systems. It is important to distinguish between a traditional underfloor air delivery system in which the room is partially mixed and a true displacement system in which any mixing of supply air with room air is kept to a minimum and air movement is primarily driven by thermal plumes.

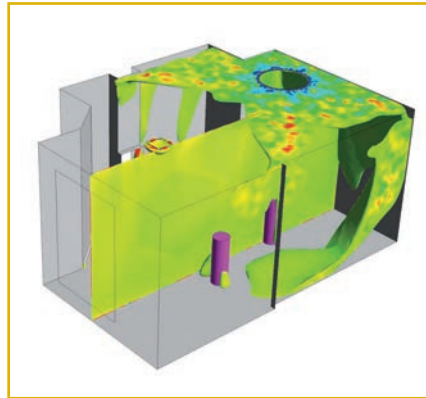
In some cases, displacement ventilation systems are supplied by underfloor air distribution. Examples include a sidewall diffuser that is fed from a pressurized plenum below the floor and a displacement diffuser with a horizontal throw installed in the raised floor.

In this case, the displacement ventilation air flow patterns, temperature gradients and other traits dictate whether the zone behaves like most other displacement ventilation systems, regardless of where the supply air to the diffuser is delivered from.

Traditional underfloor systems allow a small amount of mixing to occur in the occupied zone while limiting the amount of mixing that takes place above the occupied zone.

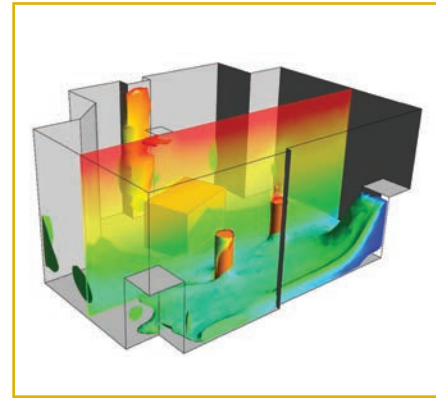


**Figure 6:** Underfloor air distribution with swirl diffuser



**Figure 7:** Temperature distribution of a mixing system

While the total amount of stratification that occurs in the zone is affected by a number of factors, it is generally desirable for stratification to occur because it will lead to advantages similar to those found in a zone with traditional displacement ventilation. These advantages include higher IAQ, better thermal comfort and possible energy savings. As a contrast to traditional displacement ventilation systems, in some situations higher cooling loads can be treated with a UFAD system while maintaining a comfortable temperature gradient. Generally speaking, increasing the flow rate out of a UFAD diffuser will reduce the amount of stratification that occurs for a given heat load. With traditional displacement ventilation, the temperature gradient increases as the cooling loads increase; and the maximum amount of heat that can be removed from a space is effectively limited by this gradient. ASHRAE (2010a) sets this limit for temperature gradient at 5 °F [3 °C] for a standing occupant



**Figure 8:** Temperature distribution of a displacement system

and 3.6 °F [2 °C] for a seated occupant. Therefore, in some cases, UFAD may be able to handle higher cooling loads than a displacement ventilation system.

### Room Air Flow Patterns

Underfloor air distribution systems, using turbulent diffusers, have a room air flow pattern which differs from that of conventional overhead mixing systems and displacement ventilation systems.

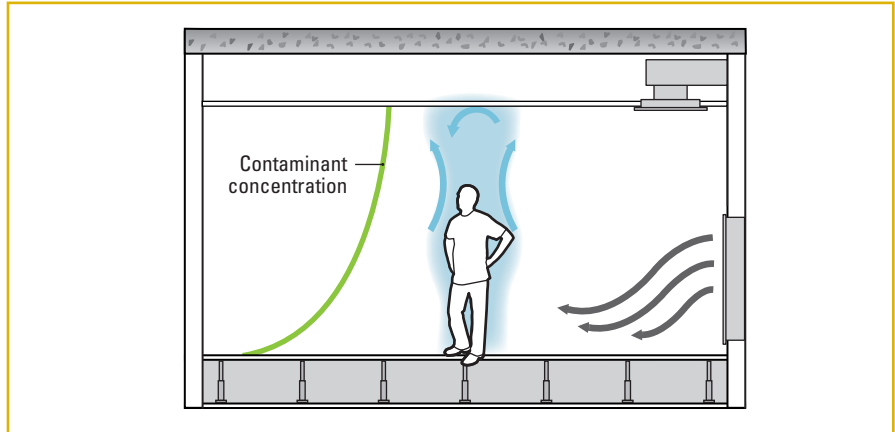
With conventional mixing systems, the conditioned supply air is discharged horizontally at high level and high velocity. The air jet induces room air, mixing with and conditioning the entire volume of air in the room. This results in a very uniform temperature from floor to ceiling with an even distribution of contaminants, as seen in **Figure 7**.

A displacement ventilation system discharges the conditioned supply air at low velocity, typically at floor height. The low velocity air spreads across the floor in

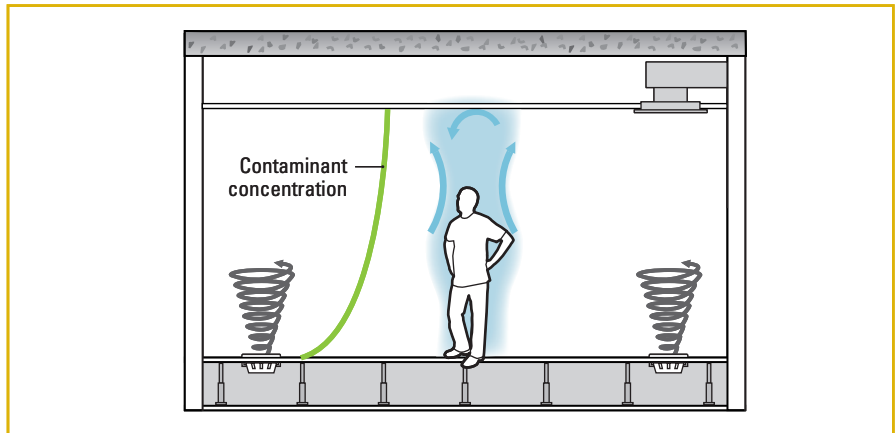
## Basics of Underfloor Air Distribution

a layer that is between 1 and 5 in. thick [25 and 125 mm]. Upon encountering a heat source, a portion of the air is heated and rises, displacing heat and contaminants upwards. The lighter warm air collects near the ceiling as it is displaced by the cool supply air, as seen in **Figure 8**. The warm air is exhausted from the high level return, carrying with it pollutants, effectively removing them from the space. Refer to Chapter 15—Fundamentals of Displacement Ventilation of the Price Engineer's HVAC Handbook for a more complete description of displacement ventilation.

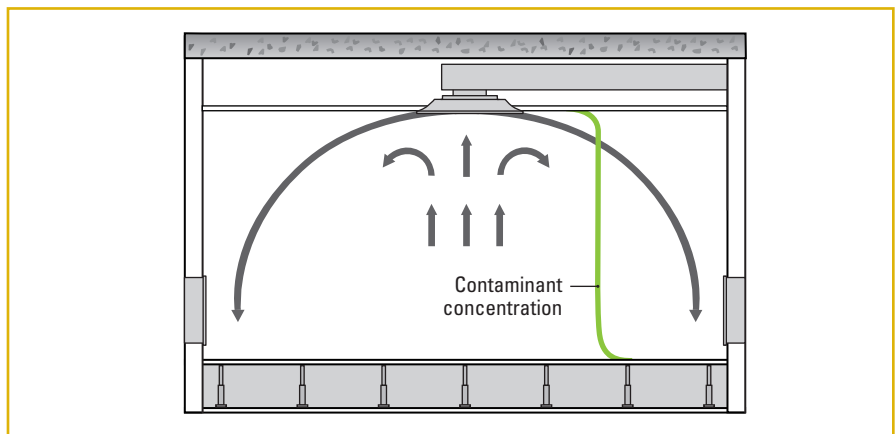
An underfloor air distribution system, shown in **Figure 10** with turbulent flow diffusers, discharges the conditioned supply air at high velocity at floor level. The discharge is a vertical swirling pattern which rapidly induces the room air and reduces the velocity to an acceptable level. In a properly designed underfloor air distribution system, the conditioned supply air discharged from a turbulent floor outlet will mix with the room air within 6 ft [1.8 m] above the floor and form a stratification layer at this point. This leaves warmer air at high level and conditioned air at low level in the occupied space, which permits the creation of a layer of higher contaminant concentration in the upper zone. As seen in **Figures 9 and 10**, a UFAD system with turbulent flow diffusers will have less overall contaminant stratification than one with displacement flow diffusers, but stratification still occurs in both systems. Conversely, mixing ventilation systems, shown in **Figure 11**, have an even distribution of contaminants through the space.



**Figure 9:** Contaminant distribution of a displacement ventilation system



**Figure 10:** Contaminant distribution of a UFAD system



**Figure 11:** Contaminant distribution of overhead mixed air distribution

## Basics of Underfloor Air Distribution

### Twist / Swirl Diffusers

Turbulent flow is generated with floor twist outlets (**Figure 12**) or "swirl" diffusers. The air outlets are constructed with a large number of inclined slots, which give the axially discharged air jets a twist component. This increases the turbulence and induction effect of the supply air jets.

The floor twist outlet is normally inserted in the floor tiles of the conventional raised floor system. A distributor basket is inserted under the air outlet to perform the following functions:

Trap solid objects that may fall into the air outlet (coins, paperclips, etc.).

Equalize the air flow to the individual air outlets by increasing flow resistance.

A damper can be inserted into the distributor basket so that the air volume rate in the air outlet can be throttled manually as required.

### Flow Velocities

Air discharge velocity from the slots is in the order of magnitude of 400 to 800 fpm [2 to 4 m/s]. These air velocities are necessary to produce induction. At a height of 3 ft [1 m] above the air outlet the air velocities are well under 200 fpm [1 m/s]. These velocities are outside the permissible limits for draft-free air movement; this is why the immediate area above the floor twist outlet is not included for comfort assessment.

A short interval of a few minutes above the floor outlet is not usually uncomfortable; however, more than 1/2 hour is bothersome for most people. For this reason floor twist outlets (pattern shown in **Figure 13**) should be placed at a minimum distance from the work place. This distance is generally 1.5 to 2 ft [0.5 to 0.6 m].

### Sound Power Level and Pressure Loss

The sound power level of the floor twist outlets is relatively low and is under a room NC level of 20 at maximum air volume flow rate for most cases. It is therefore easy to meet the specified acoustic requirements in offices. Pressure loss with an open damper and maximum air volume flow rate is in the order of 0.06 to 0.12 in. w.g. [15 to 30 Pa]. This determines the minimum pressure requirement within the pressurized floor plenum to ensure adequate air flow through the outlets.

### Displacement Diffusers

Displacement ventilation is created if, instead of the axial upward discharge, a horizontal radial discharge of supply air is applied. These diffusers are designed to radially deflect the supply air shortly after discharge from the air outlet. **Figure 14** illustrates a displacement flow diffuser. After the supply air has been radially deflected it spreads horizontally in a circular pattern along the floor (**Figure 15**). At heat sources



Figure 12: Twist diffuser



Figure 13: Twist diffuser air pattern



Figure 14: Displacement flow diffuser



Figure 15: Flow diffuser air pattern

in the room, such as computers, occupants or other equipment, the air ascends at a very low velocity as it is pulled into a thermal plume, passes through the occupied zone and reaches into the upper zone where it is exhausted as warm indoor air.

The supply air flow also displaces heat and air pollutants from the occupied zone upwards to the ceiling zone. While the floor twist outlets' supply air jet is more or less co-directional with buoyancy (bottom up), the jet direction with floor displacement outlets is horizontal. The subsequent upward flow of air depends solely on buoyancy. If there is no buoyancy (no heat loads in the room), the cold supply air remains in the floor zone and forms a cold air layer. Indoor air flow is therefore dominated by buoyancy, and not by jet momentum. Typically, these displacement type outlets are suitable for air volume rates equal to or less than 70 cfm [33 L/s].

### Temperature Distribution

As with floor twist outlets, the warm air is displaced upwards, forming a vertical temperature stratification. The upward flow, however, is determined only by buoyancy and not by inertial force.

Indoor air in the lower portion of the room is induced less by the supply air jets, but is affected more by convection. The flow velocities of the rising air are extremely low. As a consequence, the vertical temperature gradient is much more pronounced. For more information on displacement ventilation systems, please refer to Chapter 15—Fundamentals of Displacement Ventilation of the Price Engineer's HVAC Handbook.

### Sound Power Level and Pressure Loss

These values are somewhat higher than with floor twist outlets, but they are still relatively low. At maximum air volume flow rate, the sound power level is below NC 20 with a pressure loss of approximately 0.09 in. w.g. [22 Pa].

# Underfloor Air Distribution Engineering Guide

## Basics of Underfloor Air Distribution

### Thermal Plumes

As heat sources warm the surrounding air, the air becomes more buoyant. This causes it to rise in the space and be replaced by air from the side or from below, otherwise known as natural convection. As a thermal plume rises above the heat source, it entrains surrounding air and increases in size and volume as it loses momentum, moving away from the heat source, as depicted in Figure 16. The maximum height to which a plume will rise is dependent on the strength of the heat source; as more heat is transferred to the surrounding air, the initial momentum of the plume will increase. Also, a room with more stratification will reduce the density differential of the plume relative to the room air as it rises and, as a result, the height to which the plume will rise.

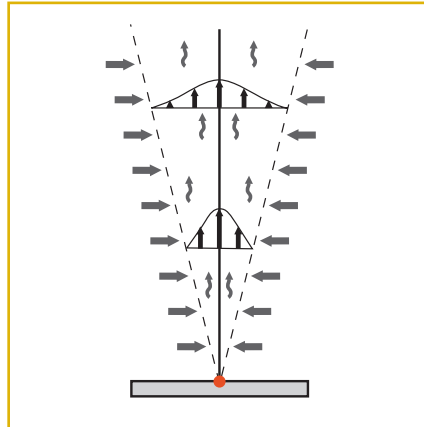


Figure 16: Thermal plume (ASHRAE, 2001)

### Stratification

One of the main driving forces behind the benefits realized with underfloor air distribution is the formation of a stratified environment. As previously defined, stratification is the creation of a continuous series of horizontal layers of air with different characteristics (e.g. temperature, pollutant concentration) within a conditioned space.

When turbulent or swirl type underfloor diffusers are used to deliver air to the space, the amount of stratification is dependent not only on the heat sources, but also on the flow rate of the diffusers. Some induction is allowed to take place in the region below the peak throw height of the diffuser, but thermal stratification also occurs. Conversely, in the region above the throw height of the diffuser, defined as the height at which the air pattern is 50 fpm, the air does not mix with supply air, and is thus subject to a very limited amount of induction. This region retains the heat and pollution that it has gathered without reintroducing these undesirable qualities back into the mixed portion of the room. As noted previously, thermal plumes develop around heat sources and help drive air upward from heated objects. Common practice is to design the throw height equal to or less than the upper limit of the occupied zone, which is normally defined as 6 ft [1.8 m] above the floor. By doing so, the volume of air above the occupied zone does not mix with the volume of air below the occupied zone, meaning heat and pollutants will not travel back into the occupied zone once they have left.

Figure 17 shows a graph of average temperature vs. height. The two curves represent two similar rooms; one in which turbulent or swirl type diffusers are used and one in which displacement diffusers are used. Note that although the temperature gradients are different for the two systems, each experiences stratification in the occupied zone. Previously held

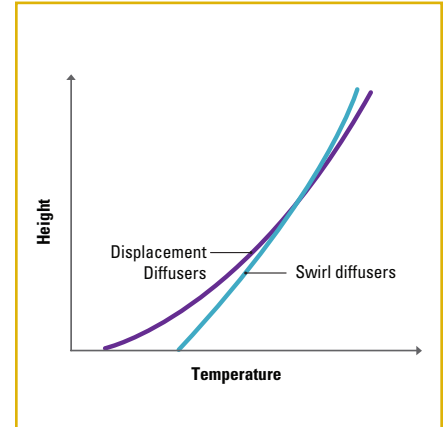


Figure 17: Temperature stratification with DV and UFAD

beliefs suggested that the lower portion of the room with swirl diffusers would become a perfectly mixed zone with little to no stratification occurring below the peak throw height of the diffuser. Studies have since proven this notion to be untrue. The amount of stratification that occurs below the peak throw height of the diffuser is, however, affected by the flow rate of the diffuser.

Occupants' exhaled air is warmer than room air and thus will tend to rise naturally into the stratified zone, taking with it the germs, bacteria and gasses (such as CO<sub>2</sub>) it contains. Heated objects set up thermal plumes that drive fresh air upward, meaning warmer bodies will receive more air flow across them than inanimate objects without thermal plumes. The action caused by these thermal plumes leads to better ventilation effectiveness and increases indoor air quality in the occupied zone. The convective portion of heat loads that are situated in the stratified zone do not contribute to the total heat load in the occupied zone. These loads simply heat up stratified air that is trapped in the upper zone. Essentially, the stratified air gains even more heat from these loads which makes the return air temperature higher, but has little to no direct effect on the occupied zone.

In order to maintain comfort, ASHRAE recommends limiting the temperature gradient to no greater than 5 °F [3 °C] between the foot and head for a standing occupant and no greater than 3.6 °F [2 °C] for a seated occupant. The stratified layer above the occupied zone is allowed to experience a larger temperature gradient because comfort is not a concern in this area. For maximum benefit, it is suggested that the air be allowed to stratify as much as possible above the occupied zone. The designer

should not allow any mixing to occur above the stratification layer so as to maximize the benefits outlined above. For this reason, diffusers with a throw not greater than the occupied zone should be selected for the designed operating conditions.

### Stratification Height

In Figure 18,  $Q_{supply}$  represents the supply air flow into the room from a turbulent floor diffuser,  $Q_R$  is the upward moving air flow contained in thermal plumes formed above heat sources, and  $Q_i$  is the downward moving air flow resulting from cool surfaces such as a window. In this example, the stratification height,  $Y_{st}$  will occur at the height where the net upward moving flow,  $Q_R - Q_i$ , equals the supply air flow,  $Q_{supply}$ . It is important when designing and operating UFAD or DV systems to maintain the stratification height near the top of the occupied zone (6 ft [1.8 m]) in order to trap contaminants above the occupants. If the building occupants are typically in a seated position, a lower stratification height (e.g. 4 ft [1.2 m]) may be acceptable. The region above the stratification height may be referred to as the upper zone, while the region below it may be referred to as the lower zone.

It is important to note that if the total amount of supply air flow rate is greater than the rate of air flow rising upward due to thermal plumes ( $Q_{supply} > Q_R - Q_i$  at all heights), no stratification height will exist and the room will not exhibit a distinct upper zone. This essentially means too much air is being delivered for the amount of heat in the room.

Another important note is that if the peak diffuser throw height is greater than the stratification height, some of the air from the upper zone may become entrained back into the lower zone. This is an undesirable

## Basics of Underfloor Air Distribution

condition that can lead to reduced indoor air quality and lower ventilation effectiveness, as some of the pollutants that would otherwise be trapped in the upper zone are brought back into the lower zone. If the diffuser throw height is lower than the stratification height, the stratification height should be the same as a displacement system with the same diffuser flow rate. That is, given a constant  $Q_{supply}$ ,  $Y_{st}$  will not be affected by diffuser throw height so long as the throw height is less than  $Y_{st}$ .

### GREEN TIP

Lower stratification heights will result from a reduced air flow which can lead to energy savings from conditioning a lower quantity of supply air. Savings may be found in both the reduced chiller and primary fan capacity.

### PRODUCT TIP

The Price RFTD diffuser has a very high induction rate and throws less than 60 in. [1.5 m] at full capacity (115 cfm) and less than 42 in. [1.1 m] at a standard air flow rate (70 cfm).

The use of twist type outlets will cause the supply air to be injected vertically with momentum and mix with room air. As the cool supply air settles, it falls back down to the floor level. The use of displacement type diffusers will cause the supply air to enter the room along the floor and form a layer of cool air that is primarily driven upwards by thermal plumes.

An important design consideration is to ensure that the diffuser does not throw past the stratification height. Grilles, liners and some swirl diffusers have throws that do not meet this criteria and are therefore only suitable for use along perimeter walls where the skin load takes priority over the air quality.

If an interior floor outlet throws past the stratification height it will induce air in the upper zone, pulling heat and pollutants back into the occupied zone. The ventilation effectiveness of the system decreases the stratification, and therefore much of the energy savings may be reduced. Effectively, the space becomes similar to a fully mixed system.

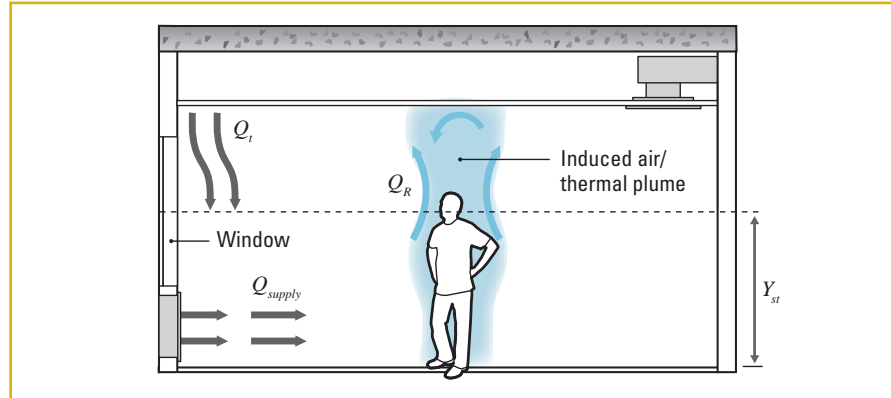


Figure 18: Stratification height

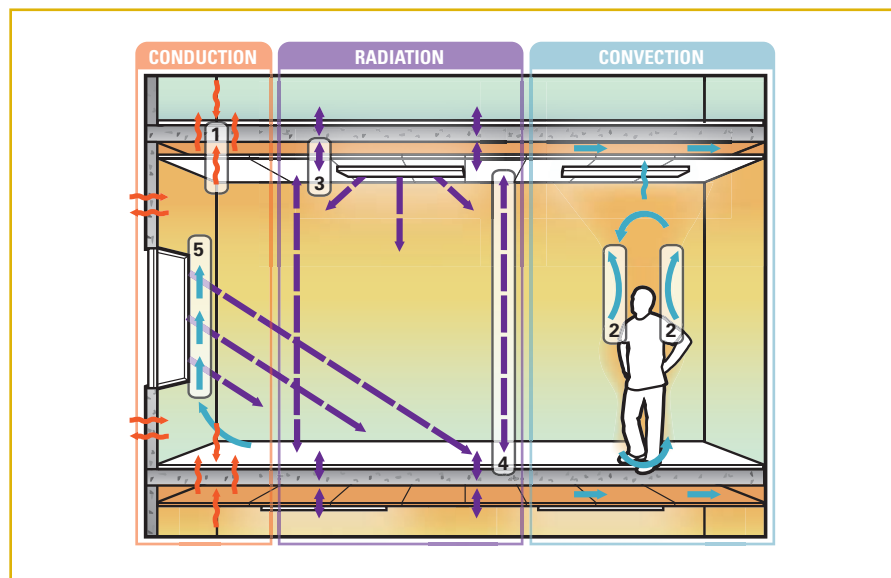


Figure 19: Heat transfer pathways in a UFAD system

### Thermal Comfort

ASHRAE Standard 55-2010 defines thermal comfort as the "condition of mind which expresses satisfaction with the thermal environment and is assessed by subjective evaluation." There are several contributing factors to thermal comfort, some of which require additional consideration in a building with an underfloor air distribution system.

### GREEN TIP

If the supply air throws past the stratification height it can induce heat and pollutants and pull them back into the occupied zone. This will reduce the indoor air quality and can increase the energy consumption of the system.

Ensuring the diffuser throw does not exceed the stratification height (typically 6 ft [1.8 m]) will help achieve the design air quality, energy savings and ventilation effectiveness.



## Basics of Underfloor Air Distribution

One of the major considerations when designing the layout of underfloor diffusers is the draft that can occur if supply air is too cold or the air velocity is too high across an occupant's body. This is especially true for occupants who may be sensitive to air currents near the floor, such as children or occupants with open toed shoes or bare legs. The use of higher supply air temperature helps to reduce draft complaints, but care must still be taken when placing diffusers near occupants. Diffusers with a vertical throw should not be used directly under seats and tables. Instead, displacement type diffusers or diffusers that throw horizontally may be a better option for these locations. Placing diffusers sufficiently far away from stationary occupants can also help reduce the number of complaints.

### Heat Transfer Pathways

The distribution plenum common to underfloor air distribution systems provides flexibility and can simplify the distribution of many building services, as discussed previously. This plenum space also has a significant impact on the way heat moves throughout the building. Unlike ducted systems, a considerable amount of thermal exchange takes place between the supply and return plenums and the room, as well as with each other. Figure 19 shows the various heat transfer pathways that are typical to a space conditioned with underfloor air distribution. The distinguishing characteristics are explained below.

1. The conditioned air in the supply plenum will conduct heat through the raised floor tiles, away from warm objects such as occupants and equipment, as shown in Figure 20. Radiant exchange also takes place between the top surface of the floor tile and any warm body in the room. As a result of increased return air temperatures, heat transfer will occur between the ceiling surfaces and the concrete structural slab above the ceiling.

If the slab is not insulated, a significant amount of heat will conduct from the return air through the slab. In a multistory building, the supply plenum of the floor above also exchanges heat with the slab. The additional heat gained by the supply plenum due to this mechanism is the other major contributing source of thermal decay.

The total heat gain into the plenum is a major contributing factor to thermal decay. The amount of heat removed directly by the plenum can be up to 40% of the total heat load in the room. This means as little as 60% of the total heat load in the room needs to be conditioned by the supply air, though this number is subject to variation depending on the conditions in each space.

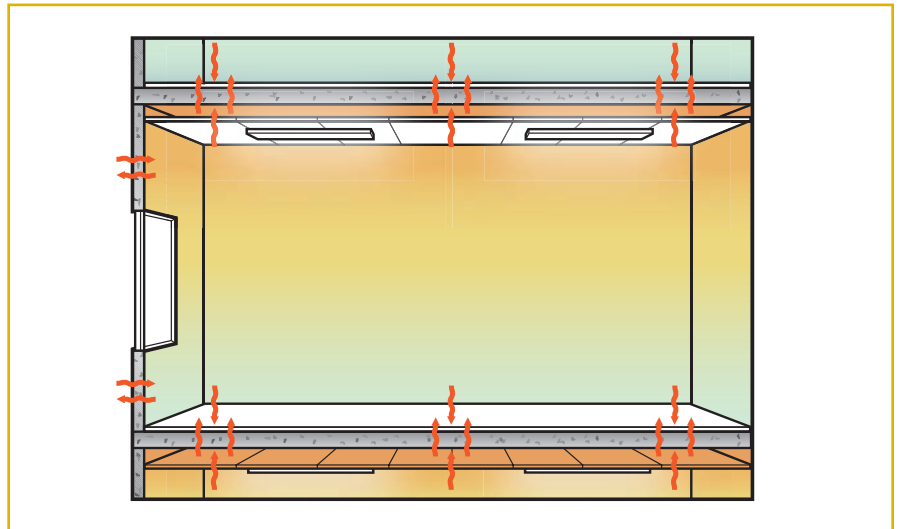


Figure 20: Conduction of heat into the supply air plenum

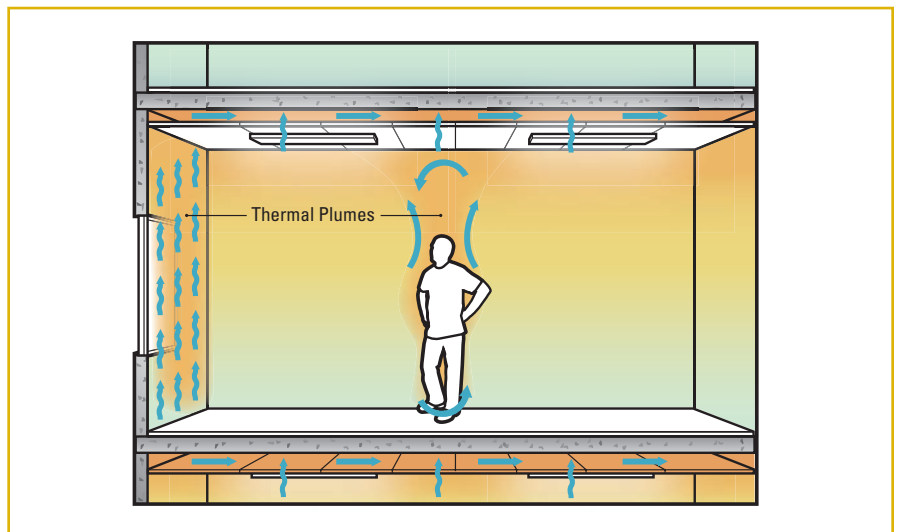


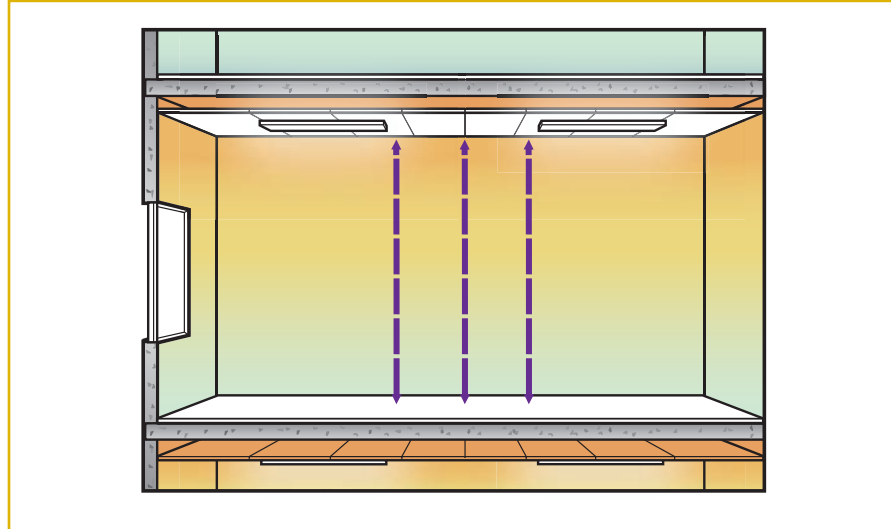
Figure 21: Thermal plumes and natural convection

2. Several different modes of heat transfers take place in the interior of the space. Removal of internal gains due to occupants and equipment occurs via a combination of natural and forced convection, as shown in Figure 21. Introducing low velocity air at floor height allows the natural convection to create stratification. Objects that are located above the stratification height, such as lights, do not contribute the convective portion of their load to the room. Instead, the warm air surrounding the object simply creates a thermal plume that rises upwards and does not mix into the occupied zone. This type

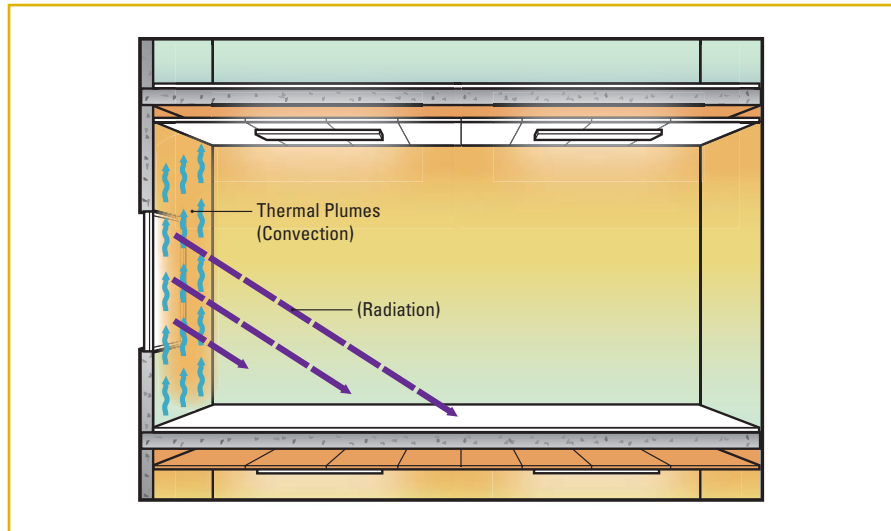
of upward air movement driven by buoyancy affects the rate of heat removal from a body. Due to the abundance of warm air at the ceiling level, the ceiling surface and return plenum will also be at an elevated temperature. These surfaces are close to the temperature of return air, which is normally in the neighborhood of 80 °F [27 °C] for a stratified system.

## Basics of Underfloor Air Distribution

3. Along with transfer of heat from the ceiling plenum through the concrete slab to the floor above, radiant heat transfer will also take place between the ceiling and the raised floor located below, as indicated in **Figure 22**. Since the raised floor is at a lower temperature and the ceiling is at a higher temperature, the gradient between these surfaces will cause radiant heat transfer to occur.
4. Solar radiation causes a large amount of heat gain near the perimeter of the building. The cool floor allows solar heat absorption to occur in this area. The warm temperatures of exterior walls and glazing can drive thermal plumes at the perimeter, which can be augmented by forcing air upwards to help extract heated air from the space. Thermal plumes that are desired with a UFAD system can be set up by perimeter solar heat. This heat can be effectively removed by allowing the plume to occur and returning the air at a high level while replacing the air with floor level conditioned air (**Figure 23**).



**Figure 22:** Radiant exchange between floor and ceiling



**Figure 23:** Thermal plumes at the perimeter

## Air Distribution Methods

There are basically two methods of supplying air to an underfloor ventilation system. One is to use a pressurized plenum and the second is to duct the supply air to each of the air outlets, similar to an overhead system.

### Pressurized Plenum

A supply plenum is formed in the cavity between the structural floor slab and the access floor, as depicted in **Figure 24**. This space is typically pressurized in order to deliver air to the floor diffusers, but may also be used as a zero pressure plenum where the plenum pressure is equivalent to that of the occupied space. Zero pressure plenums are typically used in natural ventilation systems and are not very common. There are several advantages to using a pressurized supply plenum:

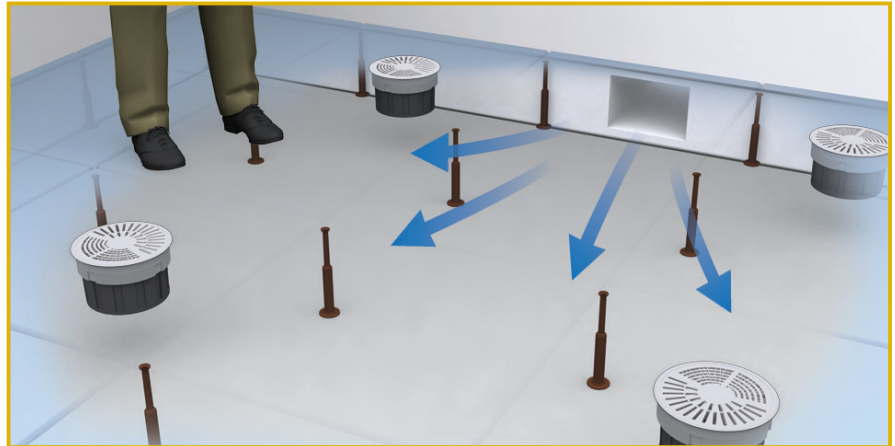
**Simple Design** – the underfloor cavity eliminates the majority of branch ductwork and requires little in terms of control. Interior zones are typically CAV and zone temperature is controlled using pressure reset.

**Flexibility** – a common distribution plenum allows for reconfiguration, or churn, of the zone above with little impact on the air delivery system. Diffusers are easily relocated due to the absence of attached ductwork. In addition, the addition or reduction of supply air to a zone can be easily achieved by adding or removing diffusers. To add a diffuser to an already occupied space is as easy as cutting a hole in the raised floor and dropping in a diffuser. To remove a diffuser, the floor tile may be replaced with one that is solid.

**Installation and Balancing** – because these diffusers install in pre-cut holes, there is very little time required to install. Floor diffusers all have a similar pressure drop and, as a well-designed plenum is a self-balancing cavity, there is very little balancing required.

### Ducted Supply

In some applications, the use of a ducted supply system, as depicted in **Figure 25**, may be warranted. For most applications, ducting should be limited to the supply of perimeter zones. One of the key advantages of a ducted supply is the decoupling of the building mass from the HVAC system. System latency and supply air heat gain is reduced, allowing the system to perform more like an overhead air distribution system in terms of the reduced effect of thermal decay and the ability to deliver either warm or cool air to the space effectively. The use of ductwork enables variable temperature air to be delivered by a terminal unit or air handler while being insulated from the surrounding concrete slab and raised floor. Additionally, effect of the thermal storage is reduced because only the air inside the



**Figure 24:** Pressurized plenum



**Figure 25:** Ducted supply

ductwork and the ductwork itself needs to be cooled or heated along the pathway, rather than the entire plenum.

An important benefit of using ductwork beneath the raised floor is to effectively deliver supply air to the perimeter of the building. When a pressurized plenum is used perimeter areas are often the furthest distance from air handler supply ducts, which could lead to a pressure drop between the supply point and the perimeter diffusers, rendering diffusers subject to minimal positive static pressure at their inlets. This means perimeter diffusers may not be able to supply enough air to the control zone. This effect, combined with the possible heat gain described above, can cause conditions at the perimeter that are less than ideal for supplying cool air to the space where skin loads are present and cooling loads can be large. The main advantage of using a ducted supply on the perimeter zone is to alleviate these problems.

Lined ductwork may provide higher insulation against thermal decay, but is not necessary in all cases. Most times, simply separating the supply air stream from the slab and raised floor will allow heat transfer to be significantly reduced. Advantages of using unlined sheet metal include cost, ease of installation, and ease of coordination of the ductwork for things such as cable trays that run directly beneath the ductwork.

Some underfloor systems do not use a raised floor at all. Instead, the concrete slab is core drilled to accept diffusers from above and the underside of the slab is ducted. In this case, the types of equipment and control schemes become similar to that of a conventional overhead ducted system. VAV terminals are commonly employed to control a zone of diffusers, while individual diffuser adjustment is seldom used in this case.

## Air Distribution Methods

Another alternative, although even more rare, is to install a completely ducted system above the slab but below a raised floor. Again, thermal decay and leakage issues are greatly reduced in this type of design, but most of the advantages related to installation and flexibility of a typical UFAD system are lost. In most cases where underfloor ductwork is used, a common pressurized plenum delivers supply air to most of the zones and separate ducted zones are created within the plenum for areas such as perimeter zones or special zones.

### Common Plenums

The design of the underfloor plenum is one of the most important design decisions when laying out a UFAD system. There are some general recommendations that should be considered. Wherever possible, an underfloor plenum should be a continuous space in order to promote isotropic conditions; that is, uniform conditions in all directions. However, building shape and application will affect this. Most newly constructed underfloor systems utilize a pressurized plenum that spans the entire footprint of the building on each floor. There may also be smaller sub-plenums fed by the same air supply but controlled separately, or multiple independent plenums that are served by separate air handlers.

A plenum may extend through multiple control zones. As air travels through the plenum, it picks up heat due to thermal decay. The slight differences in air pressure from one location to another can cause similar diffusers to perform differently despite being placed in the same plenum. The floor plate in Figure 26 may take advantage of a common plenum design and benefits from the following advantages:

### Reduced Control Complexity

There is only one plenum and, therefore, only one pressure controller required, although averaging of the plenum pressure at a few points in the plenum is prudent to ensure even air distribution.

### Redundancy

If the building supply plenums are fed from more than one air handler, there is redundancy in the system. If one of the air handlers is being serviced, the others will be able to provide the affected zone with conditioned air, though perhaps at a slightly reduced capacity.

### Simplified Equipment Control

The air risers supply air to each level with the plenum inlets individually controlled by the local pressure controller, specific to that level. The air handling equipment is then controlled by a duct static pressure sensor mounted in the riser.

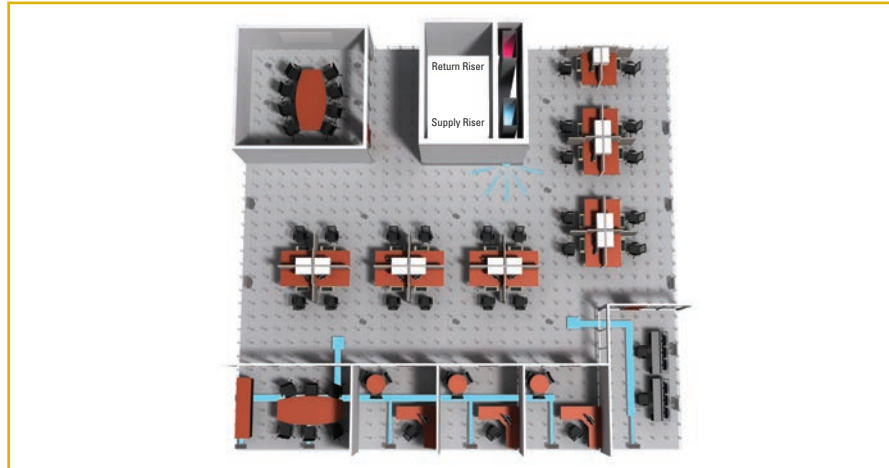


Figure 26: Square floor plate with common plenum

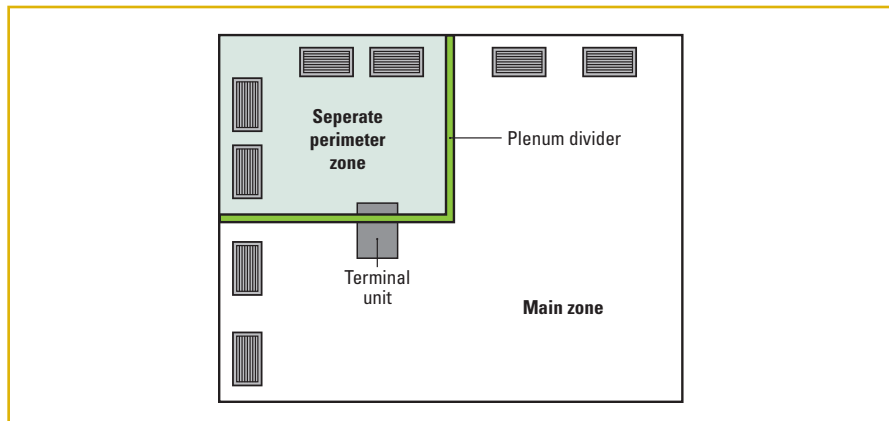


Figure 27: Rigid underfloor plenum divider creates a separate perimeter zone

### Simplified Zoning of VAV Spaces

When a common plenum is used, VAV spaces can be easily implemented by using VAV outlets.

### Divided Plenums

There are some applications where it makes sense to use a divided plenum. One such case may be the use of a divided plenum along the perimeter, as depicted in Figure 27. This allows dedicated equipment to be used to handle the skin load. Dedicated perimeter equipment might have increased cooling capacity over the equipment servicing the interior. As well, the perimeter of the building may experience large variations in loading, while the interior may not. This means that the separated perimeter equipment can have a highly variable speed fan and multiple stages of cooling and heating, whereas the interior equipment may be more simple. In winter, supplying warm air into the divided perimeter plenum reduces

the number of fan powered terminals or auxiliary heaters required in the building. The major limitation of this type of system is in the spring and fall months when the equipment is switching between heating and cooling modes. The thermal mass of the slab is active in this type of system and its latency will decrease the system's efficiency.

Another key consideration that must be accounted for is leakage between adjacent plenums through holes made in the dividers to accommodate building services. This type of leakage can cause control problems between zones and the extra barriers can also cause frustration and coordination issues during construction. Whenever leakage is present between two adjacent plenums with different supply temperatures, there is also reduced energy efficiency. Basically, as more plenum dividers are added, less of the advantages of using a common plenum, as described previously, are realized with the UFAD system.

## Diffuser Types

### Interior Diffusers

Interior zones are typically treated as cooling-only zones. For these areas, the underfloor plenum transports supply air at a specific temperature and pressure beneath the zone. Diffusers are placed in the raised floor and draw air from the pressurized plenum, injecting the air directly into the occupied zone. Diffusers placed in interior zones must be capable of being located near occupants and not throwing past the stratification height in order to maintain a thermally comfortable space while promoting stratification. Diffusers with high induction rates rapidly mix the supply air with room air to moderate the temperature difference and lower the local air speed, thereby reducing drafts and making themselves more suited to use near occupants.

Interior spaces are normally associated with relatively constant loads throughout the occupied hours. This is mainly due to the skin load being treated on the perimeter, leaving interior loading predominantly composed of occupant, lighting and equipment loads. In addition, most interior spaces have net cooling loads year-round.

Many advantages of an underfloor HVAC system stem from using pressurized plenums rather than a network of ducts to deliver conditioned air to diffusers. This method is preferred for most applications as it is the most flexible and economical. Increased flexibility, reductions in ductwork and associated costs, ease of balancing reduced fan energy requirements are a few advantages that can be gained by using a pressurized plenum to transport conditioned supply air. The flexibility comes as a result of the ability to increase or decrease air flow to a specific building location by simply adding or removing diffusers.

When placing interior diffusers into a raised floor above a pressurized plenum, the general procedure is to simply cut a hole in the floor and drop in the diffuser, securing as necessary. Most UFAD diffusers are pressure dependent, allowing an amount of air to flow into the space that is dictated by the pressure in the underfloor plenum. Manually adjustable diffusers allow the user to adjust air flow, pattern, or both in order to create comfortable local conditions for the user. Automatic diffusers are controlled by an underfloor controller. The controller usually accepts signals from a local thermostat, building management system (BMS), or both. These diffusers provide VAV air flows without manual operation. Some diffusers allow a combination of automatic and manual adjustment so that each zone can be controlled by a thermostat or BMS, yet still allow individual users to alter their local comfort conditions. One example would be



**Figure 28:** Turbulent flow diffuser

a diffuser that automatically adjusts its air volume via an underfloor controller, yet is able to be manually adjusted by an occupant who can change the direction of the air flow from the diffuser.

When selecting a diffuser the designer has options between non-adjustable diffusers, automatically adjustable diffusers, or manually adjustable diffusers. In many cases, manually controllable diffusers can be located in areas near occupants and supplemented with non-adjustable diffusers in areas such as hallways and corridors where no specific individual would be in charge of controlling flow to that area. Automatic diffusers would be used in specialized areas such as those that require variable air volume but are served a constant pressure plenum. It is important to consider whether the plenum will be variable pressure or constant pressure before choosing which type of diffuser will serve each zone.

#### PRODUCT TIP

The Price RPN allows an underfloor pressure controller to monitor the above floor zone pressure from beneath the raised floor without an unsightly intrusion into the occupied space.

### Manually Adjustable Diffusers

A typical interior zone consists of manually adjustable floor twist diffusers or floor displacement diffusers such as those shown in **Figures 28 and 29**. This type of diffuser is preferred for most applications because it is economical, yet allows for VAV along with personal control of each individual diffuser. There are no controls necessary on each diffuser. As occupants adjust individual diffusers, the pressure in the plenum will slightly increase or decrease. The plenum pressure controller will compensate by adjusting the amount of supply air delivered to the plenum. Since this is a pressure



**Figure 29:** Displacement flow diffuser



**Figure 30:** Automatically adjustable basket resides beneath diffuser

dependent system with regulated pressure control, there is no concern about flow adjustment in one area affecting the flow in another area. Minimum flows may be set by adjusting a mechanical stop to prevent occupants from inadvertently reducing air flow to the space below the minimum acceptable level.

### Automatically Adjustable Diffusers

This type of diffuser (**Figure 30**), can be used in any area where use of VAV is desired. Typically an automatically adjustable diffuser is used in conjunction with a constant plenum pressure regulation scheme. When a common plenum serves several zones and one or more of those zones has a variable load, the use of automatically adjustable diffusers is a good way to create a VAV zone independent of its neighbors. These diffusers will adjust the amount of air flow to a zone depending on the load, as sensed by the zone controller and thermostat. Minimum flows should be preset by adjusting a mechanical stop or by using electronic limits that can be adjusted for different conditions, to prevent occupants from inadvertently reducing air flow to the space below the minimum acceptable level.

## Diffuser Types

### PRODUCT TIP

The Price UMC3 underfloor controller has the ability to limit the minimum and maximum flows for a group of diffusers, and those flow limits can be adjusted via BACnet.

### Non-Adjustable Diffusers

Diffusers that do not allow air flow adjustment by the user or by a controller are an economical solution to serve areas where loads are constant or where a variable pressure plenum is used. In applications that require tamper-proof adjustments be made by the balancer and maintenance staff, a diffuser with a locking mechanism can be used. These diffusers usually have their adjustment mechanism located beneath the diffuser face, which requires the use of a specialized tool to access the mechanism.

### Dual Inlet Diffusers

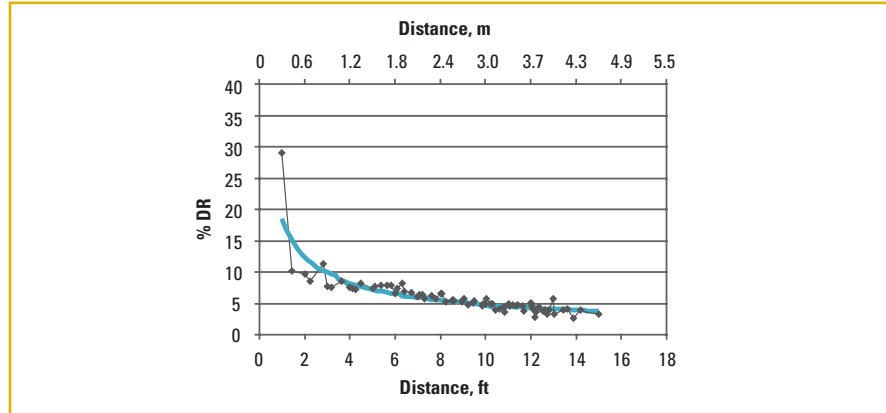
Some diffusers may have two inlets: one that accepts pressurized plenum air and one that connects to ductwork. One or both of these inlets may have a damper that allows modulation of each source independently of the other. The inlets may share a common damper, rendering the diffuser capable of operating in only one mode or the other, exclusively. In some cases it is possible to install a small plenum boot beneath a regular floor diffuser in order to allow the diffuser to accept two inlets, as shown in Figure 31.



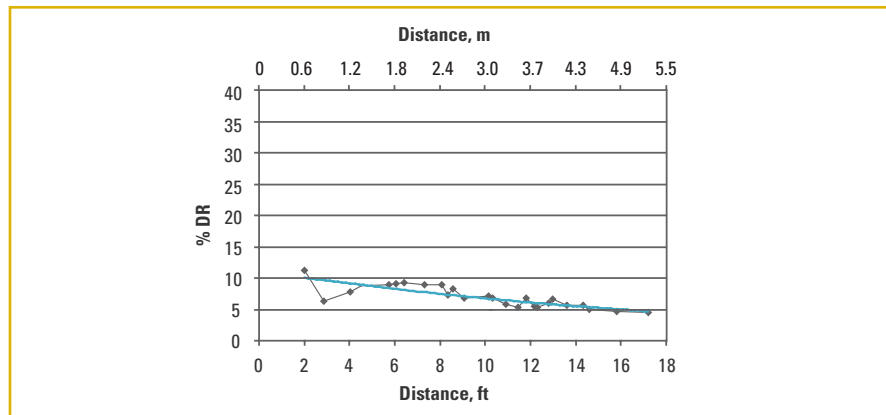
**Figure 31:** Plenum boot allows inlet connections

In any case, the diffuser is capable of providing air from two separate sources. It must be noted that by allowing ducted connections in the underfloor plenum, some of the flexibility and convenience of using a pressurized plenum is lost. These diffusers are typically used in one of three situations:

1. The diffuser serves as both a supply and return diffuser. The diffuser will act as a supply diffuser when the plenum inlet



**Figure 32:** Twist diffuser supplying 80 cfm [38 L/s],  $\Delta T = 10^\circ\text{F}$  [5.6  $^\circ\text{C}$ ], supply air temperature = 62  $^\circ\text{F}$  [16.7  $^\circ\text{C}$ ], return air temperature = 74  $^\circ\text{F}$  [23.3  $^\circ\text{C}$ ]



**Figure 33:** Twist diffuser supplying 120 cfm [57 L/s],  $\Delta T = 10^\circ\text{F}$  [5.6  $^\circ\text{C}$ ], supply air temperature = 62  $^\circ\text{F}$  [16.7  $^\circ\text{C}$ ], return air temperature = 74  $^\circ\text{F}$  [23.3  $^\circ\text{C}$ ]

is active, but as a return grille when the ducted inlet is active. The diffuser is connected to the inlet of a fan terminal unit, which creates enough suction to draw room air through the diffuser. For an example of this application, see the recirculating systems subsection of the upcoming Applications section.

2. The diffuser supplies plenum air for normal cooling operation and fan forced air for additional cooling demands. In this application the diffuser normally allows plenum air to cool the room. When an increased demand is present, a fan terminal unit would be activated to provide forced air that is able to cool the room more rapidly.
3. Both heating and cooling air flows are required from the same diffuser at different times. In this application, pressurized plenum air can flow through the diffuser to cool the space for cooling periods and warm air can flow from a terminal unit to the diffuser to heat the space for heating periods.

This application is most common on the perimeter, where skin loads can fluctuate widely throughout the year, or even on a daily basis. Interior diffusers normally do not see this type of application.

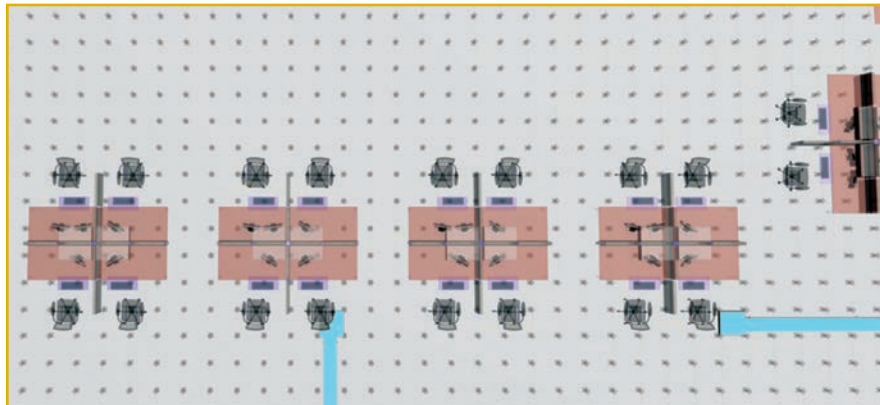
### Proximity to Floor Outlets

Figures 32 and 33 show the predicted percentage of people dissatisfied due to draft in the space at two different air flows. As indicated in the graphs below, the maximum draft risk is less than 10% two and three feet from the diffuser center with a supply air volume of 80 cfm and 120 cfm, respectively. When designing a building in accordance with ASHRAE Standard 55-2010, it is required that the draft risk is below 20%. This study indicates that this is easily accomplished. In office spaces, where it is desired to have one outlet per occupant in order to give them individual control of their air supply, diffusers can be located within each work area with little risk of thermal comfort issues.

## Example 1 - Round Floor Diffuser - IP

Consider an open office measuring 50 ft × 25 ft requiring 1325 cfm at 65 °F to manage the cooling load. This area shares a common plenum with the rest of the building, and the plenum is designed to operate at 0.08 in. w.g.

**a) Select the appropriate diffuser and find the quantity necessary to supply the office.**



Design Considerations	
Air Volume, $Q_s$	1325 cfm
$T_s$	65 °F
Plenum Pressure	0.08 in. w.g.
$A_{room}$	1250 ft <sup>2</sup>

**Price Round Floor Diffuser (RFDD)**

In order to maximize the air quality, a diffuser that creates a displacement air pattern in the occupied zone is desired. The Price RFDD is selected along with a face adjustable basket, dBA, in order to provide individual supply air volume control to building occupants. Referring to the catalog data, the air flow rate for a specified pressure is determined.

From the catalog data, at 0.08 in. w.g., each RFDD with a DB basket has a capacity of 68 cfm and a noise criteria of less than NC 15.

8 in. Round Floor Diffuser (RFDD)					
Static Pressure, in. w.g.	0.04	0.05	0.06	0.07	0.08
cfm, w/o DB	51	57	62	67	72
cfm, w/ DB/DBA	48	54	59	63	68
cfm w/ RFB (Ducted 6 in.)	49	55	60	65	69
cfm w/ RFB (Ducted 8 in.)	48	54	59	64	68
cfm w/ RFB (Plenum 6 in.)	43	48	53	57	61
cfm w/ RFB (Plenum 8 in.)	46	51	56	60	64
NC (w/o DB)	--	--	--	--	--
NC (w/ DB)	--	--	--	--	--
NC w/ RFB (Ducted 6 in.)	--	--	--	--	--
NC w/ RFB (Ducted 8 in.)	--	--	--	--	15
NC w/ RFB (Plenum 6 in.)	--	--	--	--	--
NC w/ RFB (Plenum 8 in.)	--	--	16	18	20
NC w/ RFB-(VC)	--	--	--	--	16

## Example 1 - Round Floor Diffuser - IP

The number of diffusers required is found by dividing the total air flow requirements by the air flow rate of one diffuser.

$$D = \frac{Q_s}{Q_D} = \frac{1325 \text{ cfm}}{68 \text{ cfm/diffuser}} = 19.48 \text{ diffusers}$$

Rounded up to the nearest whole number, 20 diffusers are required to ensure the maximum required air flow rate is attainable.

### b) Locate the diffusers given the furniture layout.

The proximity of an occupant to a diffuser is an important consideration in determining where to place diffusers. The draft risk for an underfloor diffuser is a function of its distance from an occupant. ASHRAE Standard 55-2010 states that a maximum of 20% draft risk is allowable. The figure below shows the draft risk around the RFDD diffuser at 70 cfm.

The RFDD operates in the acceptable region throughout all the data points, meaning the RFDD can be placed very near occupants without causing discomfort due to draft. By placing a diffuser further than 2 ft away from the nearest occupant, the predicted draft risk will be under 10%, which is half of the allowable limit per ASHRAE.

Typically, a space is laid out with one diffuser per occupant in a symmetrical manner. Any additional diffusers can be added in empty spaces such as hallways.

### Discussion

The total amount of supply air delivered to the space is actually the sum of air delivered by diffusers and category 2 leakage. Because of this, category 2 leakage may be taken into account before determining the number of diffusers required. This method is not widely used because category 2 leakage data is not readily available for all conditions and the amount of leakage can vary depending on many factors. Taking this leakage into account, the designer could use the air flow due to leakage calculated in Example 17.3 in the Price Engineer's HVAC Handbook as a contribution to the design air flow.

The supply air required to be delivered by the diffusers is found after subtracting the contribution due to category 2 leakage from the total supply air:

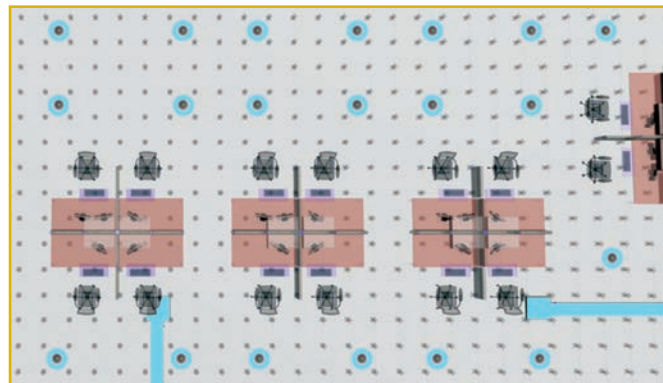
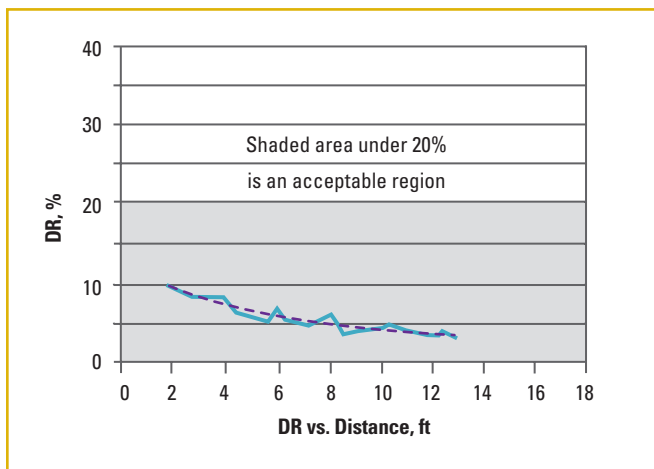
$$Q_D = Q_s - Q_{leakage} = 1325 \text{ cfm} - 220 \text{ cfm} = 1105 \text{ cfm}$$

The number of diffusers required is then determined:

$$D = \frac{Q_s}{Q_D} = \frac{1105 \text{ cfm}}{68 \text{ cfm/diffuser}} = 16.25 \text{ diffusers}$$

Only 17 diffusers are now required to deliver air to the space, which is a reduction of three diffusers from part (a).

Consider an open office measuring 15 m x 8 m requiring 625 L/s at 18 °C to manage the cooling load. This area shares a common plenum



Price RFDD 70 cfm 10 °F dT

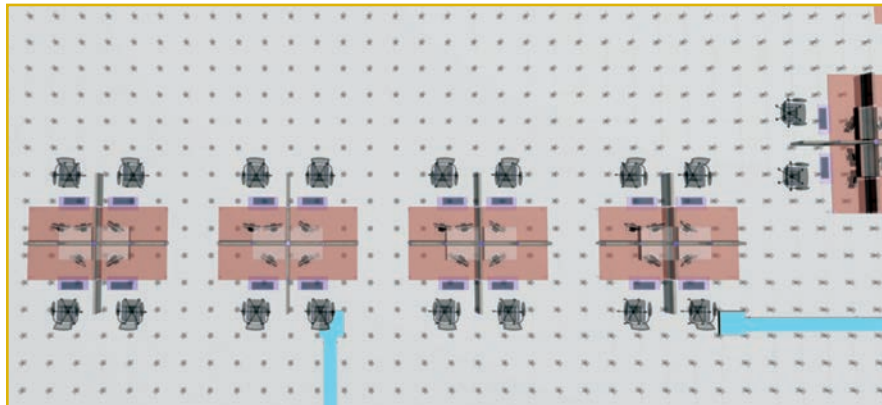


## Example 1 - Round Floor Diffuser - SI

with the rest of the building, and the plenum is designed to operate at 20 Pa.

**a) Select the appropriate diffuser and find the quantity necessary to supply the office.**

In order to maximize the air quality, a diffuser that creates a displacement air pattern in the occupied zone is desired. The Price RFDD



Design Considerations	
Air Volume, $Q_s$	625 L/s
$T_s$	18 °C
Plenum Pressure	20 Pa
$A_{room}$	120 m <sup>2</sup>

Price Round Floor Diffuser (RFDD)

is selected along with a face adjustable basket, DBA, in order to provide individual supply air volume control to building occupants. Referring to the catalog data, the air flow rate for a specified pressure is determined.

From the catalog data, at 20 Pa, each RFDD with a DB basket has a capacity of 32 L/s and a noise criteria of less than NC 15.

The number of diffusers required is found by dividing the total air flow requirements by the air flow rate of one diffuser.

200 mm Round Floor Diffuser (RFDD)					
Static Pressure, Pa	10	12	15	17	20
L/s, w/o DB	24	27	29	32	34
L/s, w/ DB/DBA	23	25	28	30	32
L/s w/ RFB (Ducted 150 mm)	23	26	28	31	33
L/s w/ RFB (Ducted 200 mm)	23	25	28	30	32
L/s w/ RFB (Plenum 150 mm)	20	23	25	27	29
L/s w/ RFB (Plenum 200 mm)	22	24	26	28	30
NC (w/o DB)	--	--	--	--	--
NC (w/ DB)	--	--	--	--	--
NC w/ RFB (Ducted 150 mm)	--	--	--	--	--
NC w/ RFB (Ducted 200 mm)	--	--	--	--	15
NC w/ RFB (Plenum 150 mm)	--	--	--	--	--
NC w/ RFB (Plenum 200 mm)	--	--	16	18	20
NC w/ RFB-(VC)	--	--	--	--	16

## Example 1 - Round Floor Diffuser - SI

$$D = \frac{Q_s}{Q_D} = \frac{625 \text{ L/s}}{32 \text{ L/s diffuser}} = 19.53 \text{ diffusers}$$

Rounded up to the nearest whole number, 20 diffusers are required to ensure the maximum required air flow rate is attainable.

### b) Locate the diffusers given the furniture layout.

The proximity of an occupant to a diffuser is an important consideration in determining where to place diffusers. The draft risk for an underfloor diffuser is a function of its distance from an occupant. ASHRAE Standard 55-2010 states that a maximum of 20% draft risk is allowable. The figure below shows the draft risk around the RFDD diffuser at 32 L/s. The RFDD operates in the acceptable region throughout all the data points, meaning the RFDD can be placed very near occupants without causing discomfort due to draft. By placing a diffuser further than 0.6 m away from the nearest occupant, the predicted draft risk will be under 10%, which is half of the allowable limit per ASHRAE.

Typically, a space is laid out with one diffuser per occupant in a symmetrical manner. Any additional diffusers can be added in empty spaces such as hallways.

### Discussion

The total amount of supply air delivered to the space is actually the sum of air delivered by diffusers and category 2 leakage. Because of this, category 2 leakage may be taken into account before determining the number of diffusers required. This method is not widely used because category 2 leakage data is not readily available for all conditions and the amount of leakage can vary depending on many factors. Taking this leakage into account, the designer could use the air flow due to leakage calculated in Example 17.3 in the Price Engineer's HVAC Handbook as a contribution to the design air flow.

The supply air required to be delivered by the diffusers is found after subtracting the contribution due to category 2 leakage from the total supply air:

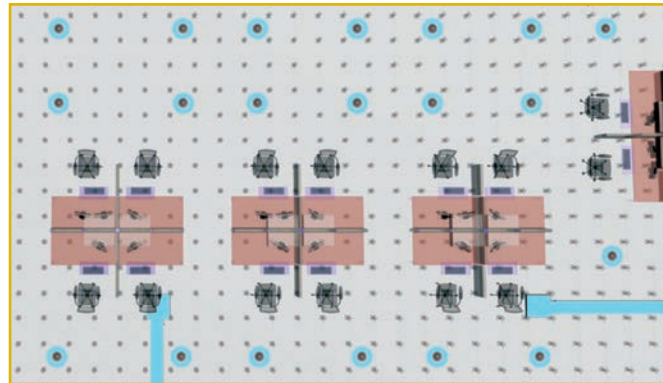
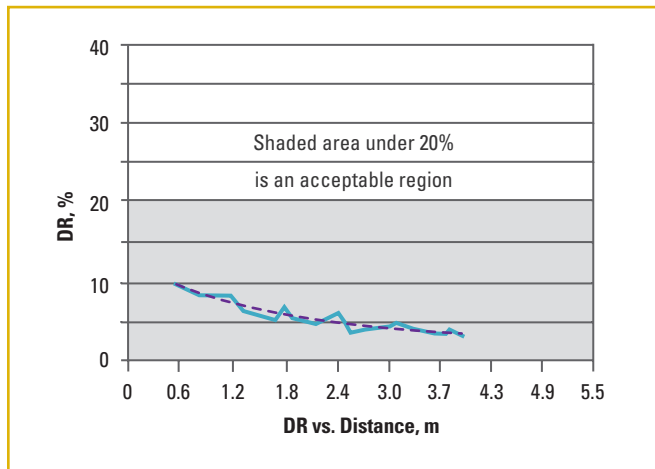
$$Q_D = Q_s - Q_{leakage} = 625 \text{ L/s} - 106 \text{ L/s} = 519 \text{ L/s}$$

The number of diffusers required is then determined:

$$D = \frac{Q_s}{Q_D} = \frac{519 \text{ L/s}}{32 \text{ L/s diffuser}} = 16.22 \text{ diffusers}$$

Only 17 diffusers are now required to deliver air to the space, which is a reduction of three diffusers from part (a).

### Perimeter Diffusers



Price RFDD 32 L/s 5.5 °C dT

## Diffuser Types

Perimeter diffusers must be able to provide air to condition the envelope loads and prevent the outdoor environment from causing uncomfortable conditions in the occupied spaces. Less restriction is imposed on perimeter diffusers with regards to occupant comfort due to the fact that these diffusers are located outside of the occupied zone.

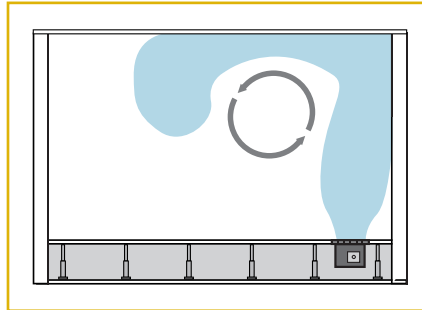
Though perimeter spaces can extend into the building by several feet, an air curtain that is contained to within 1 ft [0.3 m] of the wall may be all that is necessary to condition the skin loads for this area. By containing the air curtain within 1 ft [0.3 m] away from the perimeter wall, high velocity air can be used since it does not enter the occupied zone. Comfort conditions such as draft risk do not need to be met outside the occupied zone, and for this reason perimeter diffusers are generally capable of higher flow, higher throw, and more spread than interior diffusers. Though it may be acceptable for perimeter diffusers to throw past the stratification height, diffusers should not throw past the ceiling height or else mixing of stratified air back into the occupied zone may occur, as shown in **Figure 34**.

Several strategies that allow the designer flexibility in choosing how to condition the perimeter spaces are currently available. The tried and tested method of using a terminal unit that serves either individual or multiple diffusers along the perimeter is still a very common practice today. This strategy is very similar to the way a conventional overhead supply is designed in that it allows conditioned air to “wash” perimeter walls and glazing. Perimeter diffusers may be fitted with an actuated damper to allow VAV air flow, as shown in **Figure 36**. Dual inlet diffusers offer the best of both worlds, allowing for a duct connection to a fan terminal and VAV plenum air flow.

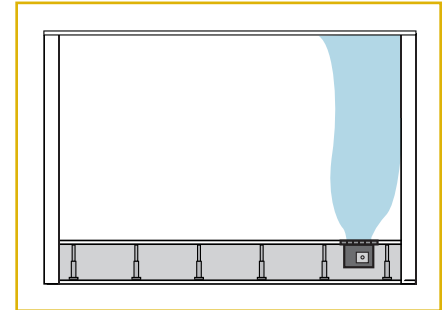
### Integrated Heaters

Some diffusers utilize the pressurized plenum air without the need for a booster fan. These products can be equipped with integrated heaters, also known as room-side heat. The major advantage of providing room-side heat is the elimination of terminal units and the disadvantages associated with them, including installation, noise, vibration, maintenance concerns, lack of flexibility, and the increased costs. In addition, some of the radiant energy of the heater is effectively transferred to the occupied space which can lead to efficiency gains along with providing greater controllability and comfort. **Figure 37** depicts a perimeter diffuser with an integrated heater while **Figure 38** shows how the diffuser operates.

### Recirculating Heaters



**Figure 34:** Perimeter diffuser with excessive throw



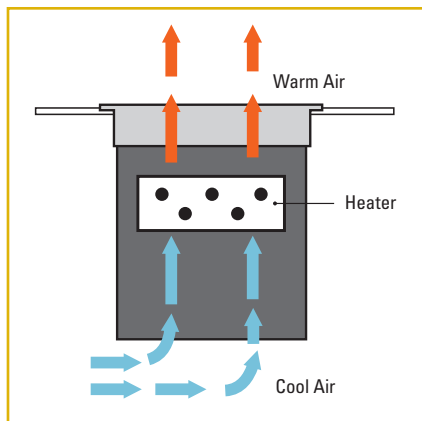
**Figure 35:** Perimeter diffuser with throw height equal to ceiling height



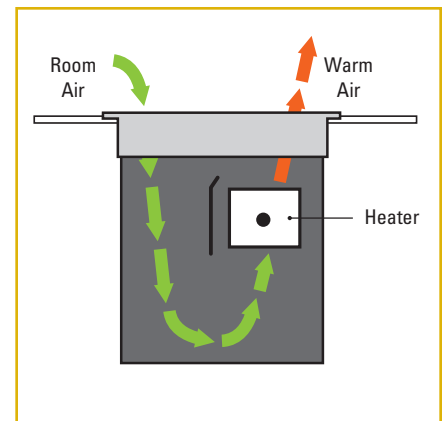
**Figure 36:** Perimeter diffuser with actuated damper



**Figure 37:** Perimeter diffuser with integrated heater



**Figure 38:** Perimeter diffuser with integrated heater showing air flow pattern



**Figure 39:** Recirculating perimeter diffuser showing air flow pattern

Some diffusers induce room air across a heating coil to provide heat to the zone. These diffusers do not reheat supply air, but may use supply air for cooling mode. **Figure 39** shows the basic functionality of a recirculating perimeter diffuser. Natural convection drives the air movement in this type of heater. While these diffusers may

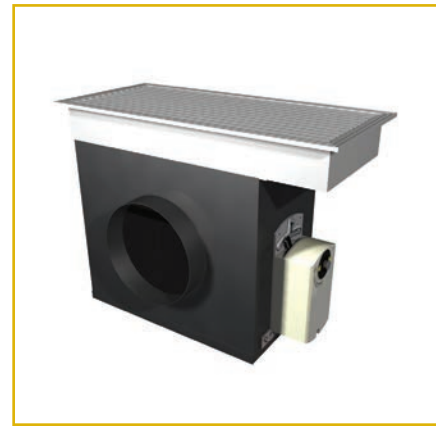
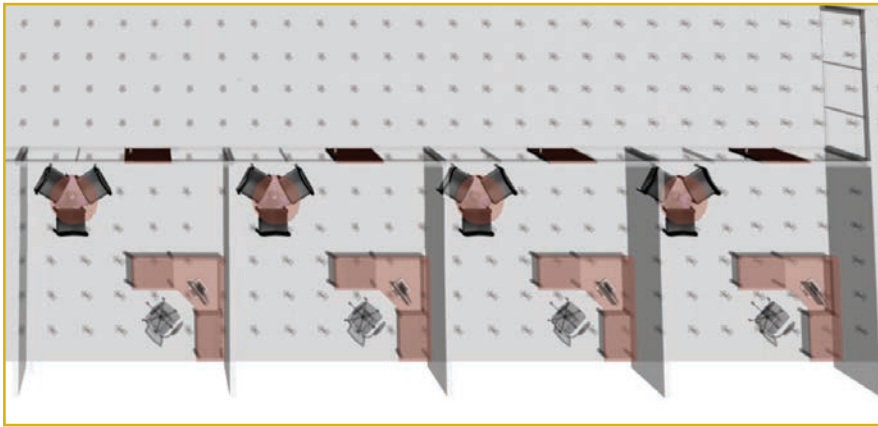
operate more efficiently by using only room air for reheat applications, the total heat capacity is reduced compared to diffusers that allow higher air flow across the coil, such as those that utilize pressurized supply air.

Consider a perimeter space with four adjoining private offices, each measuring

## Example 2 - Selection of Perimeter Diffuser - IP

11 ft x 11 ft with a 10 ft high ceiling. Each office requires 4,500 Btu/h for heating and it has been calculated that each office requires 150 cfm for cooling. The offices share a common plenum with the rest of the building and the plenum is designed to supply 65 °F air at 0.05 in. w.g. A fan powered terminal unit has been previously selected to provide a constant discharge air temperature of 100 °F during heating mode while the ambient room temperature is 70 °F. The terminal unit is designed to operate during heating mode only and will not provide any flow during cooling mode.

a) Calculate the amount of air required to condition each office.



Price Linear Floor Heater (LFG-HC)

Cooling air flow is given. Heating air flow is calculated using the following parameters:

Design Considerations	
Heat Load, $q$	4500 Btu/h
$T_s$	100 °F
$T_{room}$	70 °F

Assuming the room becomes fully mixed during heating mode, the amount of air required to treat the heat load is calculated as follows:

$$Q_s = \frac{q}{1.08 \Delta T} = \frac{q}{1.08 (T_{room} - T_s)} = \frac{4500 \text{ Btu/h}}{1.08 \text{ Btu/h cfm } ^\circ\text{F} (100 ^\circ\text{F} - 70 ^\circ\text{F})} = 139 \text{ cfm}$$

b) Select the appropriate diffuser to supply each of the offices.

To allow heated air to flow from the terminal unit during heating mode and utilize the pressurized plenum to supply air during cooling mode, Price LFG-HC is selected. Deflection vanes are chosen in order to minimize the throw while spreading the air further, covering more of each office's perimeter wall. Referring to the catalog data, the air flow rate for the specified pressure is determined.

Design Considerations	
Heating Air Volume, $Q_{s,H}$	139 cfm
Cooling Air Volume, $Q_{s,C}$	150 cfm
Plenum Pressure	0.05 in.

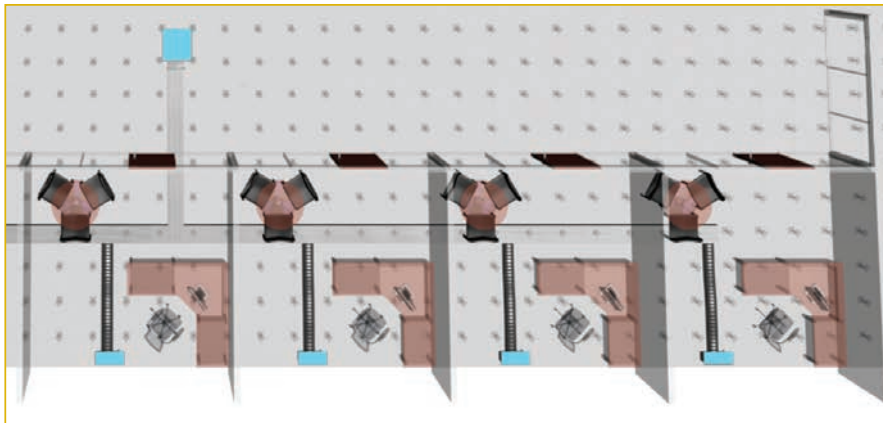
## Example 2 - Selection of Perimeter Diffuser - IP

15 in. x 6 in.				
Air Flow, cfm	50	100	150	200
Static Pressure, in. w.g. (LFG-HC Plenum)	0.005	0.022	0.049	0.086
Static Pressure, in. w.g. (LFG-HC Ducted)	0.003	0.01	0.023	0.04
Static Pressure, in. w.g. (LFG-VC)	0.008	0.034	0.075	0.134
NC (LFG-HC Plenum)	--	--	--	23
NC (LFG-HC Ducted)	--	--	--	23
NC (LFG-VC)	--	--	--	21
Throw, ft (150-100-50 fpm)	1-3-9	5-9-13	9-11-15	10-13-18

From the catalog data, each LFG allows 150 cfm at 0.049 in. w.g. This tells us that during cooling mode, while the diffuser is utilizing the pressurized plenum, the diffuser will allow approximately 150 cfm, which is what our room demands.

### c) Locate the diffusers given the furniture layout.

Perimeter grilles are placed very near the perimeter wall to ensure the skin loads are conditioned effectively while reducing the draft risk. To minimize ductwork, one main trunk carries the air from the terminal unit and separate smaller ducts are used to distribute the air to each grille. A manual balancing damper is used on each small duct to equalize the flow between grilles.



### Discussion

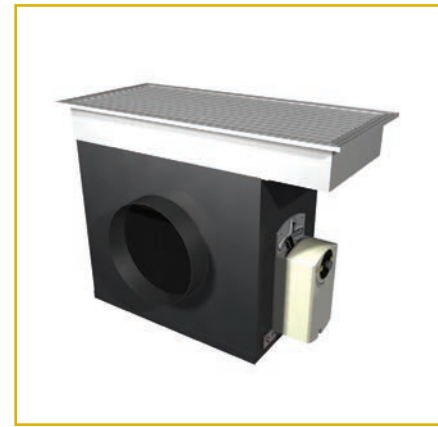
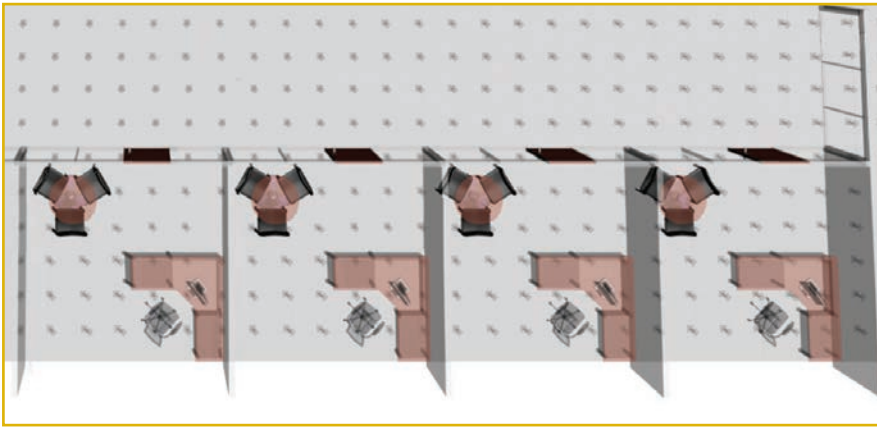
In order to reduce the throw in cooling mode, deflection blades can be used on the LFG. To reduce the throw even further, the LFG can be used at a reduced flow rate and the makeup air can be achieved through round floor interior diffusers with automatic baskets

An alternate solution to the example above is to use the same LFG grille for each office, but with the damper adjusted to allow a maximum of 100 cfm cooling flow. A round floor diffuser with dampered basket, such as Price RFTD with DBV, is added to each office. Each RFTD is allowed to flow 50 cfm, for a total of 150 cfm of cooling in each office. During heating mode the DBV basket remains closed so there is no new contribution to the room from the RFTD in heating mode.

## Example 2 - Selection of Perimeter Diffuser - SI

Consider a perimeter space with four adjoining private offices, each measuring 3.5 m x 3.5 m with a 3 m high ceiling. Each office requires 1,300 W for heating and it has been calculated that each office requires 70 L/s for cooling. The offices share a common plenum with the rest of the building and the plenum is designed to supply 18 °C air at 12.5 Pa. A fan powered terminal unit has been previously selected to provide a constant discharge air temperature of 38 °C during heating mode while the ambient room temperature is 21 °C. The terminal unit is designed to operate during heating mode only and will not provide any flow during cooling mode.

a) Calculate the amount of air required to condition each office.



Price Linear Floor Heater (LFG-HC)

Cooling air flow is given. Heating air flow is calculated using the following parameters:

Design Considerations	
Heat Load, $q$	1,300 W
$T_s$	38 °C
$T_{room}$	21 °C

Assuming the room becomes fully mixed during heating mode, the amount of air required to treat the heat load is calculated as follows:

$$Q_s = \frac{q}{1.2\Delta T} = \frac{q}{1.2(T_{room} - T_s)} = \frac{1,300 \text{ W}}{(1.2 \text{ kJ/m}^3\text{K})(38 \text{ °C} - 21 \text{ °C})} = 64 \text{ L/s}$$

b) Select the appropriate diffuser to supply each of the offices.

To allow heated air to flow from the terminal unit during heating mode and utilize the pressurized plenum to supply air during cooling mode, Price LFG-HC is selected. Deflection vanes are chosen in order to keep the throw low while spreading the air further, covering more of each office's perimeter wall. Referring to the catalog data, the air flow rate for a specified pressure is determined.

Design Considerations	
Heating Air Volume, $Q_{s,H}$	64 L/s
Cooling Air Volume, $Q_{s,C}$	70 L/s
Plenum Pressure	12.5 Pa

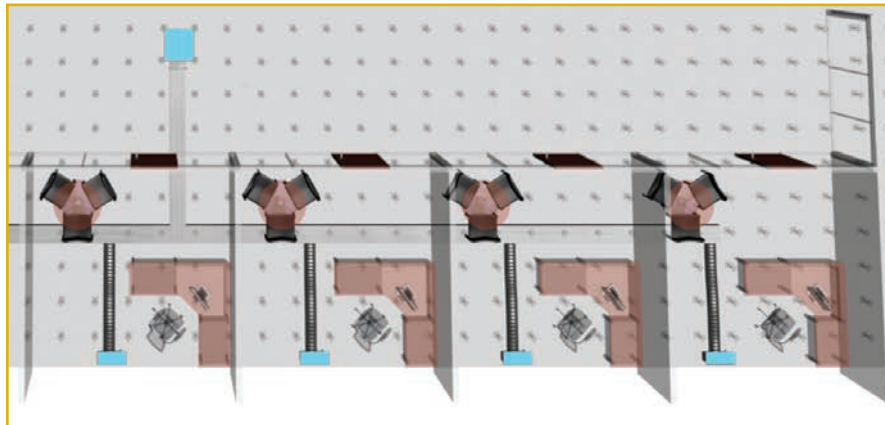
## Example 2 - Selection of Perimeter Diffuser - SI

380 mm x 150 mm				
Air Flow, cfm	24	47	71	94
Static Pressure, Pa (LFG-HC Plenum)	1	5.5	12	21
Static Pressure, Pa (LFG-HC Ducted)	0.7	2.5	5.5	10
Static Pressure, Pa (LFG-VC)	2	8.5	19	33
NC (LFG-HC Plenum)	--	--	--	23
NC (LFG-HC Ducted)	--	--	--	23
NC (LFG-VC)	--	--	--	21
Throw, m (0.75-0.50-0.25 fpm)	0.3-0.9-2.7	1.5-2.7-4.0	2.7-3.4-4.6	3.0-4.0-5.5

From the catalog data, each LFG allows 71 L/s at 12 Pa. This tells us that during cooling mode, while the diffuser is utilizing the pressurized plenum, the diffuser will allow approximately 71 L/s, which is what our room demands.

### c) Locate the diffusers given the furniture layout.

Perimeter grilles are placed very near the perimeter wall to ensure the skin loads are conditioned effectively while reducing the draft risk. To minimize ductwork, one main trunk carries the air from the terminal unit and separate smaller ducts are used to distribute the air to each grille. A manual balancing damper is used on each small duct to equalize the flow between grilles.



### Discussion

In order to reduce the throw in cooling mode, deflection blades can be used on the LFG. To reduce the throw even further, the LFG can be used at a reduced flow rate and the makeup air can be achieved through round floor interior diffusers with automatic baskets.

An alternate solution to the example above is to use the same LFG grille for each office, but with the damper adjusted to allow a maximum of 47 L/s cooling flow. A round floor diffuser with dampered basket, such as Price RFTD with DBV, is added to each office. Each RFTD is allowed to flow 24 L/s, for a total of 71 L/s of cooling in each office. During heating mode the DBV basket remains closed so there is no new contribution to the room from the RFTD in heating mode.

## Terminal Units and Controllers

### Terminal Units

Underfloor terminal units are normally designed to be installed beneath the raised floor, resting on the plenum slab. These terminal units are surrounded by plenum air, which is normally conditioned supply air under a small positive pressure. As such, a common application for underfloor terminal units is to draw plenum air and boost it by using a fan so that supply air can be discharged into diffusers at a higher pressure than would be available from the pressurized plenum alone. An example of an underfloor terminal unit is shown in **Figure 40**.

Fan powered terminal units normally serve the perimeter area by providing controlled air flow to perimeter diffusers. During cooling mode fan powered units can generate more air flow through diffusers than the pressurized plenum can, and during heating mode terminal units can activate a heating coil to provide warm air to the space.

In all cases, consideration must be paid to the lower static pressure required by underfloor diffusers in order to ensure the terminal unit controls are capable of controlling to low static pressures. ECMs are efficient throughout their operating range and can be modulated to provide VAV control to underfloor diffusers. Given that UFAD systems are often implemented in buildings where energy efficiency is considered especially important, the benefits of ECMs should be carefully considered in these situations. The ECM also allows for more flexibility in control schemes, since it is capable of variable speed operation.

### Controllers

There are three major classes of underfloor controllers: those that control the plenum pressure, those that control individual diffusers, and those that control terminal units.

### Plenum Pressure Controllers

Standalone pressure controllers that are made specifically for underfloor applications must be capable of very low pressure resolution, on the order of 0.01 in. w.g. [2.5 Pa] or less. Typical plenum pressures need to be regulated to within this range in order to be effective and allow consistent air flow through the diffusers. A common plenum pressure set-point may be as low as 0.05 in. w.g. [12.5 Pa], which means a variance of even 0.01 in. w.g. [2.5 Pa] is a variance of 20%.

Plenum pressure controllers can come in two forms. Usually, one master controller will use multiple pressure sensors to sense the static pressure at various points in a large plenum. It then uses this information



**Figure 40:** Underfloor terminal unit



**Figure 41:** Underfloor zone controller



**Figure 42:** Underfloor terminal unit controller

to adjust the air flow from the main supply duct, either by controlling a series of dampers or by modulating the main AHU fan. Alternatively, many smaller, local pressure controllers may be used, each with its own pressure sensor. These will typically modulate only the dampers on the ends of supply shafts that are located nearby the pressure controller.

### Zone Controllers

Zone controllers, or diffuser controllers (**Figure 41**), are used to control groups of diffusers that serve a single zone. The controller's main function is to read the space temperature from a thermostat or BMS signal and then actuate the diffusers in response to the zone demand. More

advanced zone controllers can be fully integrated with the BMS to monitor plenum temperatures or pressures, change actions based on occupancy, etc.

### Terminal Unit Controller

As the name implies, this type of controller (**Figure 42**) is mounted directly on an underfloor terminal unit to control the functions of the terminal unit. The controller may be capable of actuating the unit's dampers, fan, heating coil, valves, and other various options. Some terminal unit controllers are also capable of actuating diffusers that are attached to the terminal unit.

Most zones in a UFAD system can be broken down into one of three classes: interior zone, perimeter zone or special zone. Interior zones typically do not experience skin loads and have relatively stable loads. Typically, interior zones only experience cooling loads, and therefore require less equipment since the diffusers do not need to provide heat to the zone.

### PRODUCT TIP

The Price UMC3 is native BACnet compliant and can be used to communicate vital building information to the BMS while controlling up to 30 remote dampers.



## Applications

Perimeter zones are expected to treat skin loads and this could mean heat is necessary in these areas. Special zones are zones that experience a widely variable load or that demand extra controllability or functionality in order to meet the zone's special comfort criteria. An example of a special zone would be a conference room that stays unoccupied most of the day, but needs to rapidly adjust its air flow upon demand to meet the set-point.

### Interior Applications

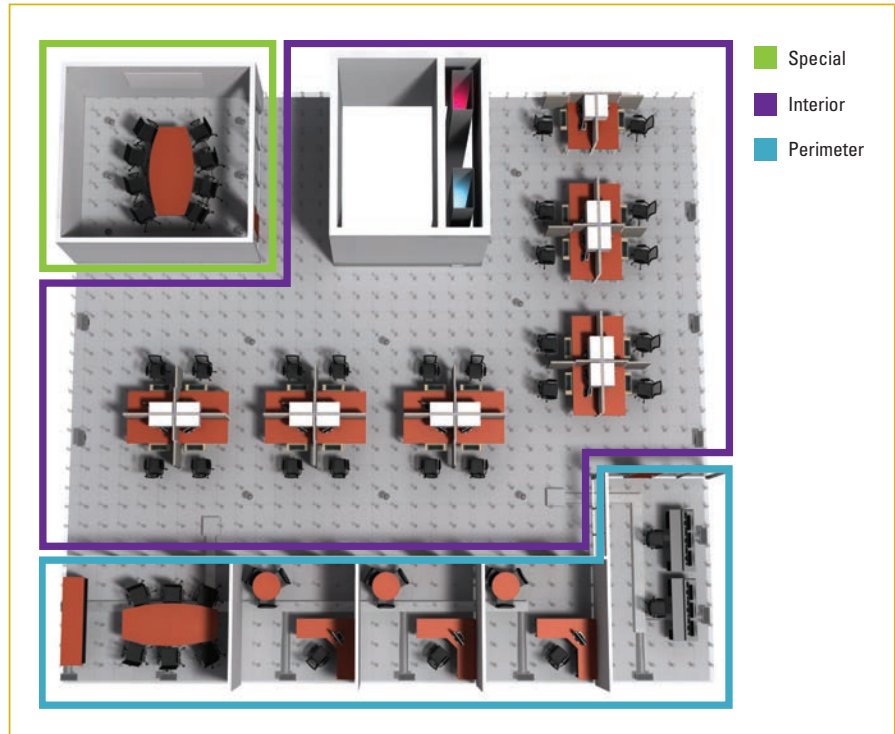
For many large open spaces such as a cubicle farm or an open plan office, as shown in **Figure 44**, large interior zones may be thought of as having nearly uniform conditions. Though the occupancy rate may differ slightly from time to time and location to location, the whole of the zone has a relatively stable load during occupied hours and may be treated as such. Loads in the interior zones are predominantly composed of occupant, lighting, and equipment loads.

### Variable Loads

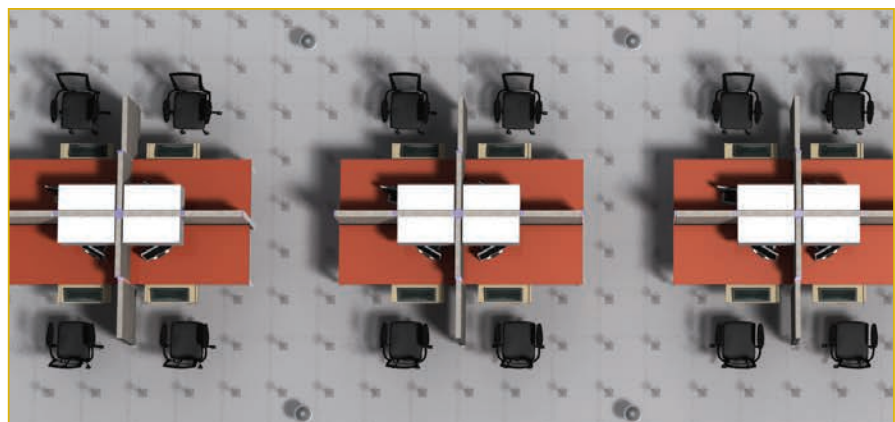
A typical interior zone consists of face-adjustable twist type or displacement type flow diffusers. **Figure 45** depicts a standard underfloor diffuser. This method is preferred for most applications as it is the most flexible and economical. The flexibility comes as a result of the ability to increase or decrease air flow to a specific building location by simply adding or removing a diffuser. This is facilitated because there are no additional controls necessary and the pressure controller regulates the zone pressure. As occupants adjust outlets, the pressure controller will adjust the amount of supply air delivered to the plenum to regulate the static pressure. Since this is a pressure-dependent system with regulated pressure control, there is no concern about flow adjustment in one area affecting the flow in another area. Manually adjustable diffusers allow the user to adjust air flow, pattern, or both in order to create comfortable local conditions for the user.

### Special Zones

Special zones such as conference rooms, meeting rooms and interior private offices can experience wide load swings due to intermittent occupancy or equipment operation. Interior zones with large swings in occupancy or equipment loads, or those that require smaller individual control zones can be thought of as special zones. There are several common options available to address these zones in order to maintain comfort levels in all areas.



**Figure 43:** Building zones



**Figure 44:** Interior zone



**Figure 45:** Floor diffuser

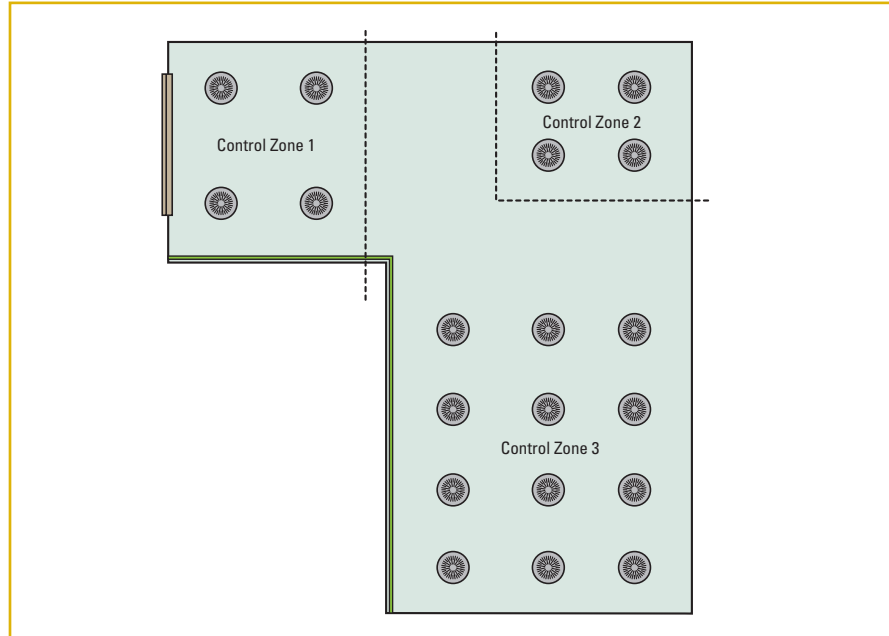
## Interior Applications

These system options include:

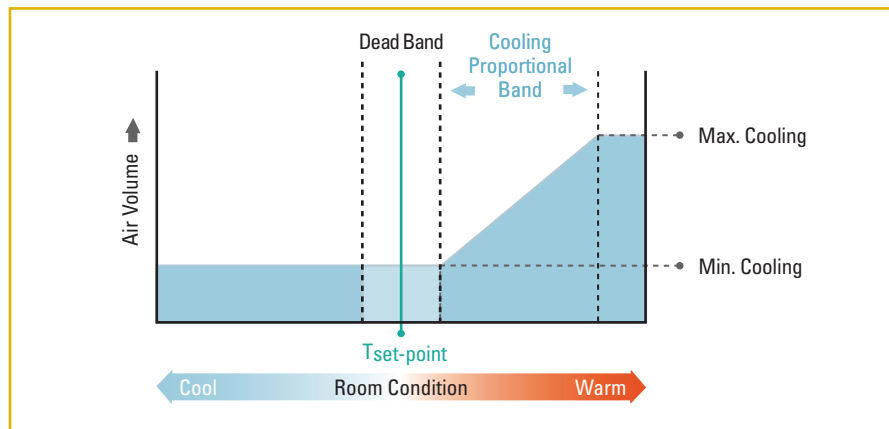
1. A control zone is formed using non-ducted variable volume round floor diffusers controlled from the room thermostat. The diffusers are all supplied from the pressurized floor plenum. In this system, a thermostat monitors the room temperature and adjusts the dampers in the diffusers to satisfy the cooling load in the space. This can be done throughout a large interior space by creating several smaller special zones, each controlled by their own thermostat, but sharing a common plenum, as shown in **Figure 46**. A typical control graph for each zone is shown in **Figure 47**.

2. A control zone is formed using a variable volume fan powered terminal unit controlled by a thermostat located in the zone (**Figure 48**). The fan terminal is ducted to constant volume outlets and supplies cooled plenum air to quickly satisfy the demand. This system allows for heating at the fan powered terminal, which may be equipped with a hot water or electric heater to handle heating loads. Thermal decay and leakage are both reduced in comparison to System Option 1, above, due to the fan pulling air from the interior of the plenum and not allowing the air to pass across the raised floor as it is transported from the terminal unit to the diffuser. Refer to the control graph in **Figure 49**.

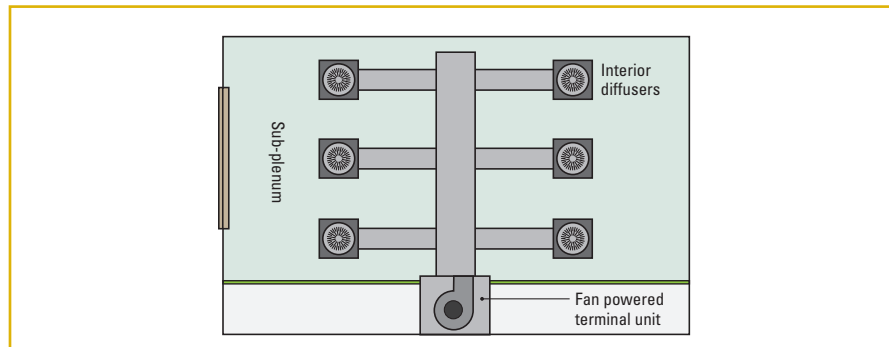
While this system option allows for a heating mode and may reduce thermal decay during cooling mode, it is less flexible than System Option 1 and the cost is usually higher due to the extra ductwork and terminal unit required.



**Figure 46:** Separate special zones sharing a common plenum



**Figure 47:** Cooling-only control graph



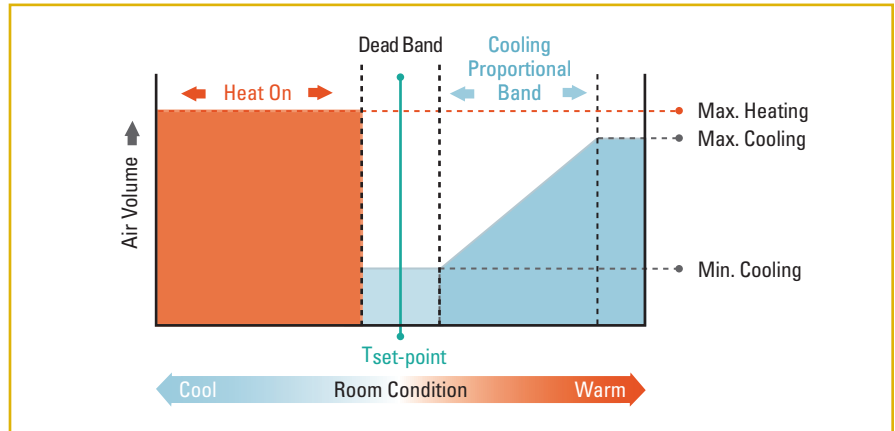
**Figure 48:** Fan terminal ducted to interior floor diffusers

## Interior Applications

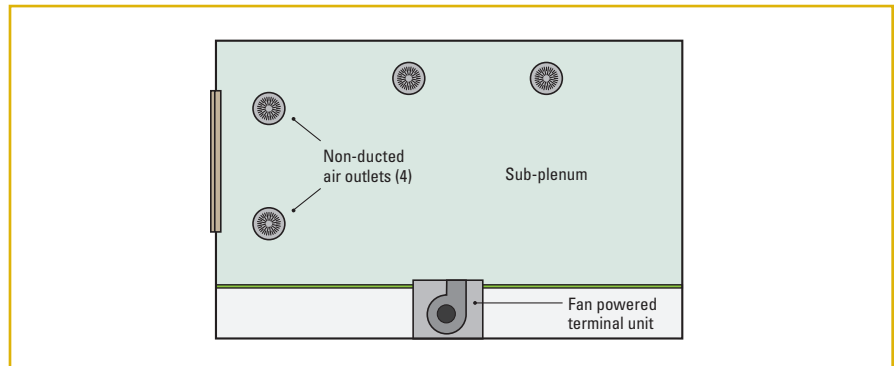
3. A control zone is formed by installing physical partitions in the plenum, forming a sub-plenum under the control zone (**Figure 50**). Two options are available to control the pressure in the sub-plenum. Either a variable volume fan powered terminal unit or a dampered duct drop from air handler can be used to pressurize the sub-plenum in response to a control signal from a thermostat located in the zone. Non-ducted constant volume air outlets discharge air from the sub-plenum into the control zone to quickly satisfy the demand. Control of these zones is accomplished by modulating the local pressure, and thus the supply air volume, by a pressure controller. This option is essentially a compromise between options 1 and 2 described above. The control graph is shown in **Figure 51**.

This system can be thought of as a combination of System Options 1 and 2 (above). While this system offers the ability to heat the zone and does not have the disadvantages associated with extra ductwork, it cannot be easily rearranged due to the immovable sub-plenum walls and it requires a fan terminal unit. Also, this system is not conducive to rapid changes between heating and cooling modes due to the thermal storage effect of the sub-plenum, including the structural slab.

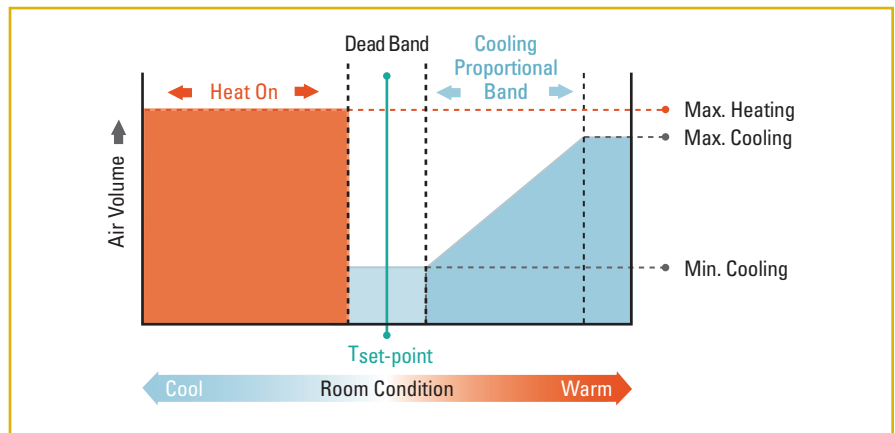
There are some zones in a building which are unsuitable for raised floor applications. Washrooms, equipment rooms and spaces that require washing down can pose significant design challenges in that liquid infiltration into the underfloor plenum needs to be considered. It can be expensive and cumbersome to make a raised floor watertight, making these spaces generally better suited to an overhead supply system. As these spaces tend to be a small fraction of the total square footage of a building, it is unlikely that they will merit an individual air distribution system. In these cases, it is reasonable to supply the same air that is supplied to the remainder of the building to the zones using UFAD. This will have a higher supply air temperature than typical OHAD systems, and will therefore have a corresponding increase in the air flow rate. For example, if the temperature of the air supplied to a mixed space is 65 °F [18 °C], the air flow requirement will be approximately twice the air flow required for an equivalent systems using 55 °F [13 °C] to compensate for the 50% reduction in supply air cooling capacity. However, it is not uncommon to seal the floor plenum in these spaces in order to keep the UFAD system intact.



**Figure 49:** Control graph for special zone with heat



**Figure 50:** Fan terminal supplying a sub-plenum



**Figure 51:** Control graph for special zone with heat

## Perimeter Applications

### Perimeter Applications

Perimeter zones are typically more complex than interior zones. These spaces generally have larger and more varying loads and often require auxiliary heat. These loads have a dramatic effect on the performance of the building HVAC system, and therefore need to be carefully considered. Ideally any UFAD system will be used with a high quality, low-e glazing system to reduce the demand on the HVAC system. This is one of the best ways to reduce HVAC system energy consumption and promote a thermally comfortable environment by decreasing the radiant asymmetry in the occupied zone. Diffusers in the perimeter areas are typically required to supply a larger amount of air to condition the envelope loads, but are not subject to the strict thermal comfort constraints placed on interior diffusers due to being located near walls, and therefore out of the occupied zone.

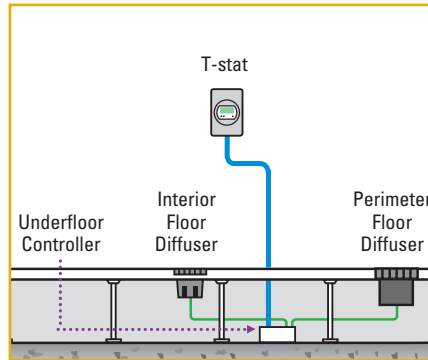
Again, there are various ways of controlling perimeter zones. Most of these strategies are similar to the methods for controlling special interior zones, but they include additional considerations for the wide range of loading conditions experienced on the perimeter. There are several perimeter systems currently in use, each with advantages and disadvantages. The following is a list of the most common applications for conditioning perimeter zones along with a brief explanation about each system:

#### System Option 1: Non Ducted, Plenum Fed Variable Volume Diffusers

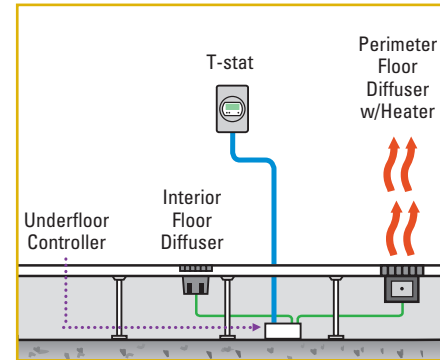
A control zone is formed using non-ducted, plenum fed variable volume linear floor grilles controlled from the room thermostat (**Figures 52 and 53**). The diffusers are supplied from the pressurized floor plenum. In this system, a thermostat monitors the room temperature and adjusts the dampers in the diffusers to satisfy the cooling load in the space. A typical control graph is shown in **Figure 54** and a typical layout in **Figure 55**.

Room-side heat may be provided by a grille with an integrated heater. These grilles are normally offered in two styles: one that only relies on natural convection during heating mode and one that allows air to flow during both cooling and heating modes.

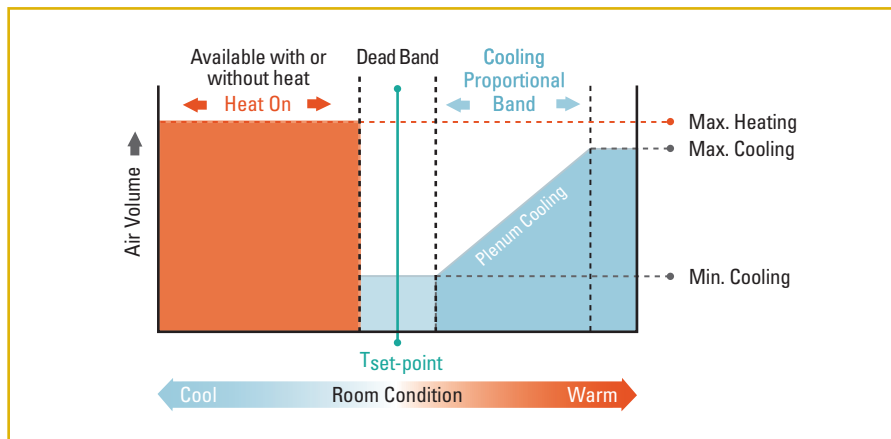
The style of diffuser that uses natural convection to provide heat to a room is also known as a trough heater. There are two common types of trough heaters. As shown in **Figure 56** the trough heater may be permanently sealed and only operable for heat, similar to a common baseboard element, and inoperable for cooling mode. In this case, alternate cooling methods must



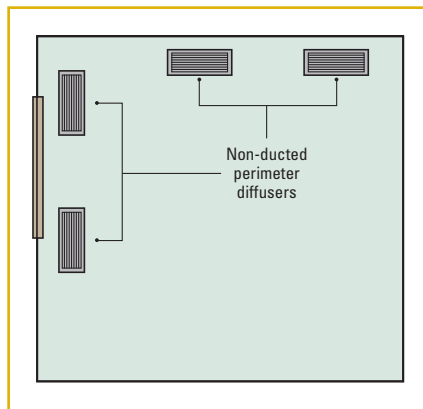
**Figure 52:** Plenum fed perimeter diffuser



**Figure 53:** Plenum fed perimeter diffuser with integrated heater



**Figure 54:** Plenum cooling binary heat



**Figure 55:** Layout of perimeter zone with plenum fed diffusers

## Perimeter Applications

be provided along the perimeter, requiring either additional cooling diffusers or alternate means of cooling the space.

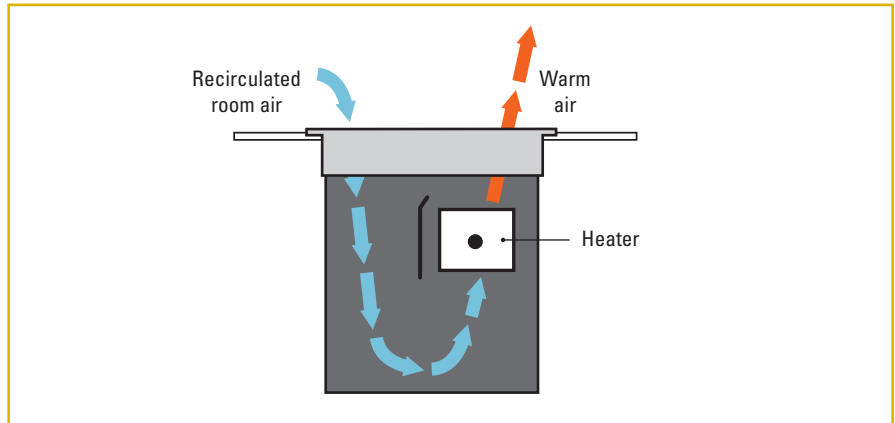
Alternatively, as shown in **Figures 57 and 58**, the trough heater may be equipped with an inlet damper that opens to allow cool supply air to be injected into the space during cooling mode and closes to allow recirculation to occur during heating mode.

The style of diffuser that allows pressurized plenum air to flow through during both heating and cooling modes can offer higher heating performance. Because air is forced across the coil, more heat transfer takes place and more heat can be delivered to the space. During cooling mode, this type of perimeter diffuser normally has a damper for VAV cooling flows.

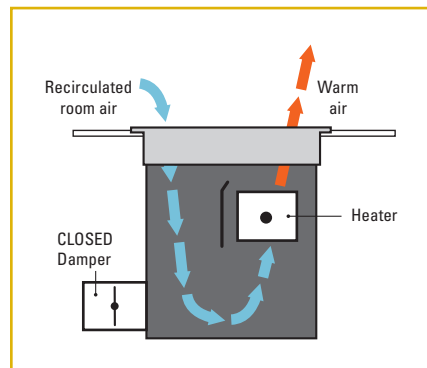
Since the perimeter area is typically located furthest away from the plenum supply point(s), thermal decay and leakage can present potential pitfalls of this control system. This problem can be exacerbated by the fact that the perimeter area typically experiences higher cooling demands than the interior of the building, and if the thermal decay is too large, the diffuser may not be able to provide sufficient cooling to this area of the building.

### System Option 2: Terminal Unit Ducted to Non-Adjustable Diffusers

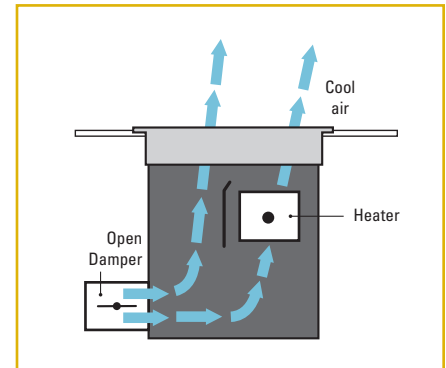
A control zone is formed using a variable volume fan powered terminal unit controlled by a thermostat located in the zone (**Figure 59**). The fan terminal is ducted to non-adjustable floor grilles and supplies cooled plenum air to quickly satisfy the demand. The terminal unit can be equipped with an ECM to vary the volume of air in order to satisfy a variable load. This fan operates in heating and cooling modes and ensures that air is delivered to the perimeter under all conditions. Refer to the layout in **Figure 60** and the control diagram shown in **Figure 61**.



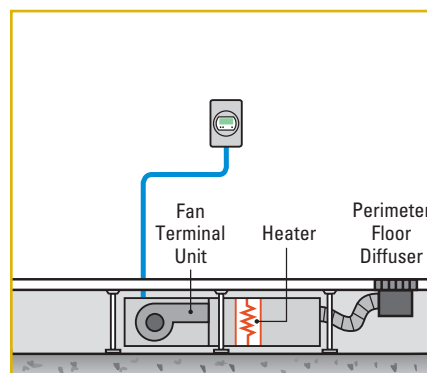
**Figure 56:** Basic trough heater



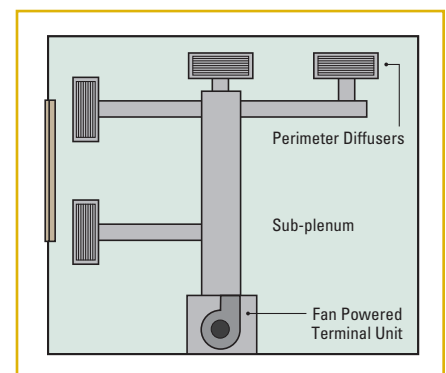
**Figure 57:** Trough heater with damper, shown in heating mode



**Figure 58:** Trough heater with damper, shown in cooling mode



**Figure 59:** Perimeter diffuser served by fan powered terminal unit

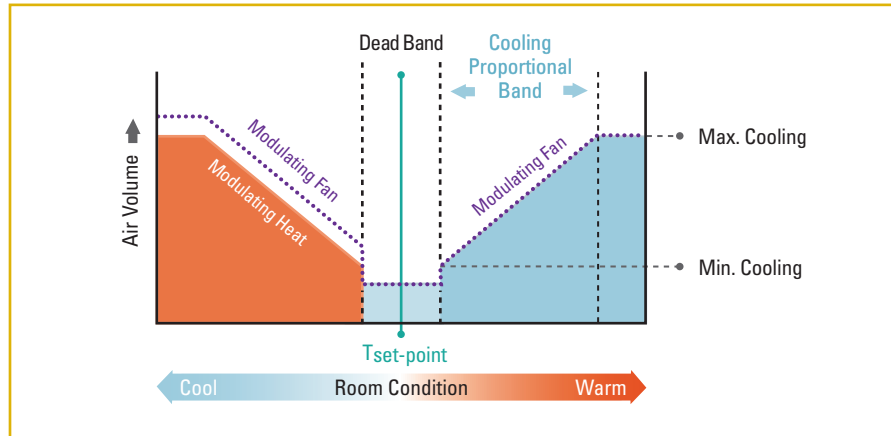


**Figure 60:** Layout of perimeter zone with diffusers ducted to fan powered terminal unit zone

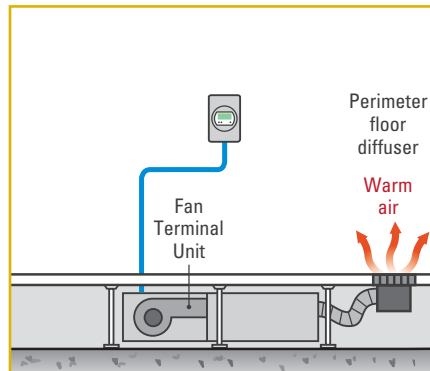
## Perimeter Applications

This system allows for heating at the fan powered terminal, which may be equipped with a hot water or electric heater to handle heating loads. This system is perhaps the most common and is also the most simple to design.

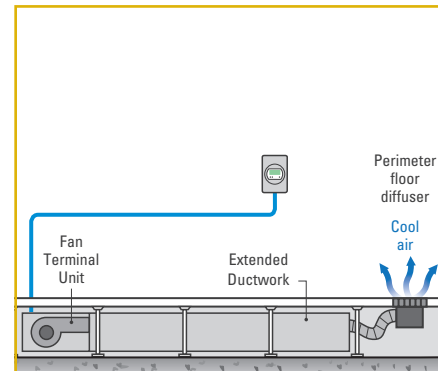
One of the limitations of systems that use pressure dependent, plenum fed VAV diffusers (such as System Option 1) is that the system's ability to meet the perimeter cooling requirement is directly coupled to the quality of construction and amount of thermal decay in the plenum. By contrast, the fan powered terminal modulates the air volume, ensuring that the zone set-point is met (**Figure 62**). For increased performance, the terminal may be located closer to the building core or plenum inlets to ensure that the cool air is being delivered to the perimeter as shown in **Figure 63**. Another advantage of doing this is lower sound levels at the perimeter, due to the increased distance of the terminal unit. There is a minor cost of increased ductwork, but the system is more likely to function as designed by decoupling the effects of thermal decay.



**Figure 61:** Perimeter diffuser served by fan powered terminal unit



**Figure 62:** Placement of terminal unit at the perimeter



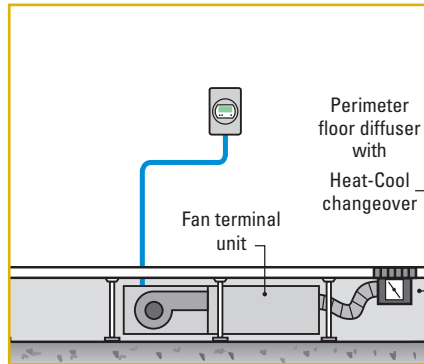
**Figure 63:** Placement of terminal unit in the core

## Perimeter Applications

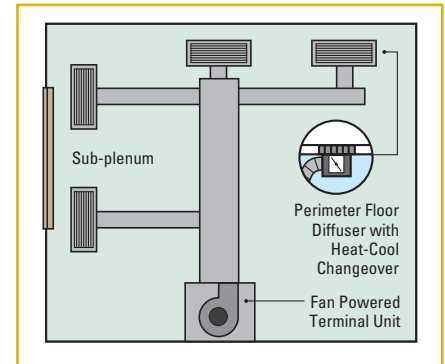
### System Option 3: Terminal Unit Ducted to Heat-Cool Changeover Diffusers

A variant of system option 2 employs heat-cool changeover diffusers (shown in **Figure 64**) so as to utilize the pressurized plenum for cooling, and only requires the fan terminal unit to run during heating mode. This will eliminate the requirement for using the fan in cooling mode by modulating the plenum dampers, but could re-introduce the plenum thermal decay issues when supplying cool air to the perimeter. Since the terminal unit, ductwork and diffuser layout would be the same for System Options 1 and 2, the main difference in operation between these systems is whether the diffusers draw supply air directly from plenum or use the fan terminal unit to draw supply air for cooling mode. The other difference is that this system provides cooling from the plenum, whereas in System Option 2, the fan terminal unit can modulate the amount of cool air with an ECM.

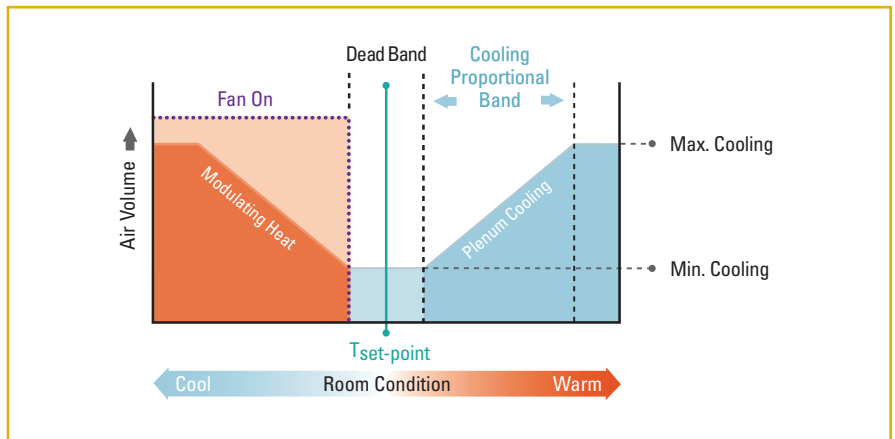
**Figure 65** shows the layout of this system, while **Figure 66** shows the control graph. Note that the fan is only on when heating is required. A close-up view of a heat-cool changeover perimeter diffuser is shown in **Figure 67**.



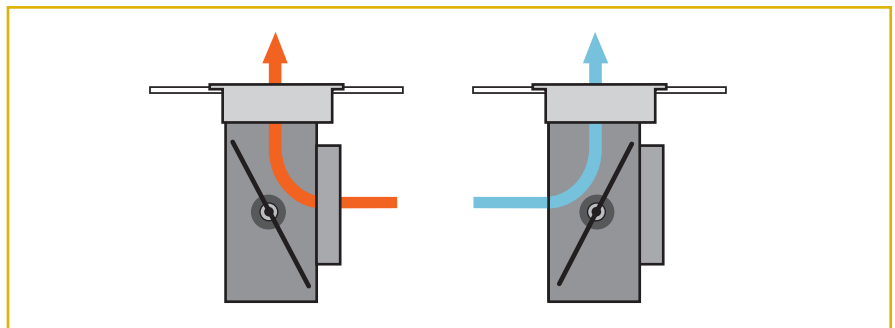
**Figure 64:** Perimeter diffuser served by fan powered terminal unit



**Figure 65:** Layout of perimeter zone with diffusers ducted to fan powered terminal unit



**Figure 66:** Modulating heat with on/off motor



**Figure 67:** Heat-cool changeover perimeter diffuser

## Perimeter Applications

### System Option 4: Sub-Plenum with Non-Adjustable Diffusers

A control zone is formed by installing a physical partition (Figure 68) in the underfloor plenum around the control zone, forming a sub-plenum. A variable volume fan powered terminal unit is used to pressurize the sub-plenum in response to a control signal from a thermostat located in the zone. Non-ducted, non-adjustable perimeter diffusers discharge air from the sub-plenum into the control zone to quickly satisfy the demand. Control for this system is similar to that of the ducted system without dampers, and is represented by Figure 69. Note that in this case the sub-plenum takes place of ductwork, containing the supply air beneath the underfloor and delivering it to each diffuser.

One issue that may come into play with this system is the thermal mass of the slab. In the spring and fall months, when the system is fluctuating between heating and cooling mode, the slab will be warming and cooling with the supply air temperature. While this is a potential limitation for interior zones, the large changes in outdoor conditions make it even more evident for perimeter systems. This will have a negative impact on the efficiency of the system. Another important difference is that this system has less flexibility in terms of expanding or contracting the size of the zone due to the physical barriers beneath the raised floor, yet it has more flexibility in terms of being able to add or remove diffusers without the need to add or remove ductwork.

### System Option 5: Dedicated Perimeter Equipment

Dedicated perimeter equipment has the advantage of supplying warm air in heating mode and cool air in cooling mode, independent of other zones and without the use of fan powered terminals. This makes the system more efficient due to the reduction of localized fan powered equipment and their associated heaters. From a control standpoint, this system is slightly more complex and less flexible as the equipment will likely service many zones on a single exposure. A polling scheme may be required to determine the heating/cooling mode. VAV diffusers with heat-cool changeover capability are also required when supplying independent zones. The underfloor diffusers and sub-plenum spaces used with dedicated perimeter equipment can be arranged in a similar fashion to those used with strategy (4), above, with the key difference being the source of the supply air for each sub-plenum zone.

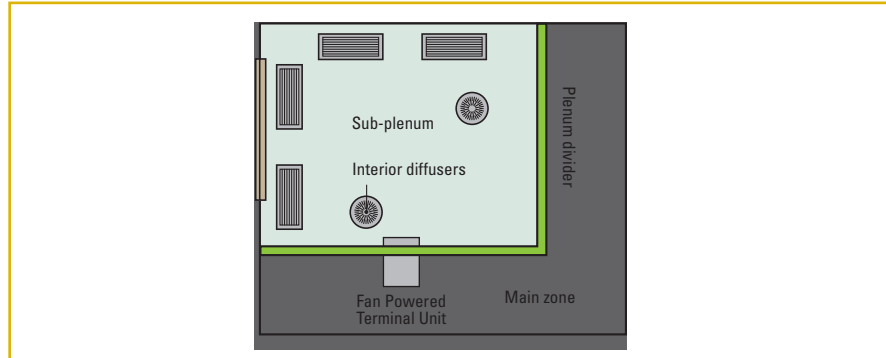


Figure 68: Layout of perimeter diffusers within a sub-plenum

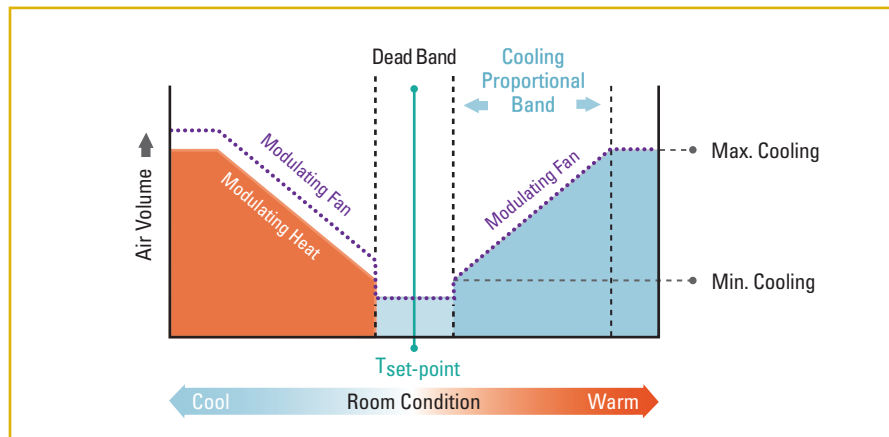


Figure 69: Modulating heat with ECM

### System Option 6: Heating and Cooling from Overhead

Using conventional overhead air distribution methods on the perimeter to condition envelope loads may be advantageous in certain situations, such as when there is a high heating load present and the warm return plenum can be recirculated to take advantage of the existing heat. Even though a raised floor is present, there isn't an explicit requirement for perimeter zones to be served by underfloor diffusers. Slot diffusers, active and passive beams, chilled sails, radiant panels, baseboard heat, and all the other various perimeter conditioning equipment may be used to condition skin loads. One major conflict that must be accounted for is that underfloor air delivery promotes an upward flow of air while overhead slot diffusers push air downward.

These opposing systems can cause undesired air collisions and other anomalies that produce system inefficiencies and uncomfortable regions for occupants. The overhead terminal units can be operated on a limited basis in order to limit some of the negative effects.



## Perimeter Applications

### System Option 7: Recirculating Systems

Another perimeter system employed today is the recirculating system. These supply cool air from the plenum to the perimeter through a VAV diffuser on the perimeter in cooling mode and use a fan powered terminal to pull air from one section of the building and push it over a heating element to be supplied to the perimeter space in heating mode.

There are two varieties of this type of system, one that pulls air from the interior space and one that pulls from the return plenum. The system which pulls room air from the interior, shown in **Figures 70 and 71**, has limited advantages. Its limitations are found in the system's higher cost, increased complexity and reduced flexibility. Each outlet is a VAV diffuser used in conjunction with a fan powered terminal. In cooling mode, each outlet modulates to meet the cooling demand; in heating mode, the outlets close from the plenum and the interior outlets become return grilles for the fan powered terminal. Warm air is supplied through grilles along the perimeter. There is an apparent advantage of drawing recirculated air from the room, compared to supply air, across the heating coil. The air along the floor in a stratified environment is typically a few degrees warmer than the supply air in the plenum. However, return air is even warmer than room air found at the floor level, so return air offers even greater recirculation advantages.

In cases where the recirculated air is pulled from the return air plenum above the zone, there may be a significant reduction in the amount of energy required to heat the supply air. Additionally, the return air may be used in recirculation mode only as a first stage of heat, delaying the requirement for auxiliary heat. The difficulty in applying this system is in the requirement for ductwork from the return plenum to the fan powered terminal usually requiring pillars or walls located nearby, and that by using return air for recirculation, pollutants are re-introduced to the occupied space. Installing these ducted perimeter systems will also reduce the flexibility and churn benefits of the UFAD system.

The costs associated with installing extra ductwork and the resulting inflexibility of each type of return ductwork system should be weighed against the potential energy benefits in each case.

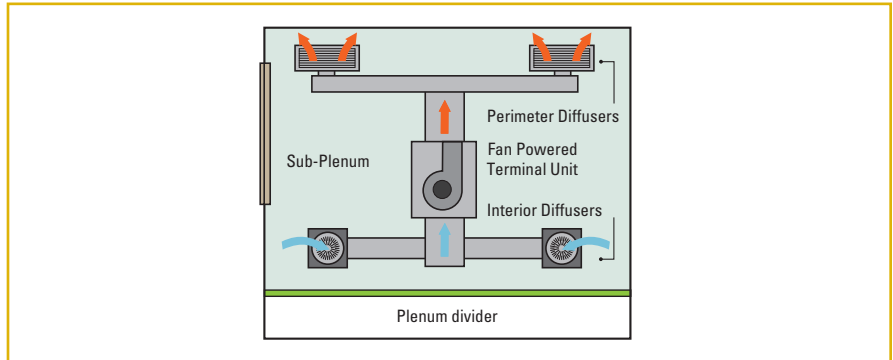


Figure 70: Recirculating perimeter system (layout view)

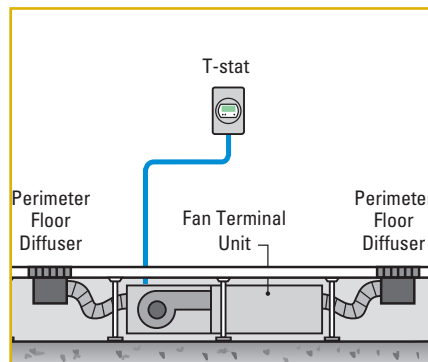


Figure 71: Recirculating perimeter system (side view)

## Typical Applications

### OFFICE BUILDINGS

#### Flexibility

Diffusers installed in a raised floor can be reconfigured at a fraction of the time of an overhead system. Given the prevalence of churn in a modern office environment, a highly configurable HVAC system can save a great amount of time and money.

#### Personal Comfort Control

The proximity of users to UFAD diffusers allows them to manually adjust air flow, providing them with a level of personal comfort control unavailable with most overhead systems.

#### Energy Savings

The reduced air volumes required to condition with UFAD result in potential energy and cost savings – a benefit in office buildings, which are frequently owner-occupied.

#### Products

RFTD / RFDD with DBA – Round floor diffusers (RFTD / RFDD) with individually adjustable baskets (DBA) are perfect for environments where personal comfort is top of mind. Not only will these diffusers and baskets allow occupants to maximize their comfort, they also allow the building to achieve LEED credits.

DBV with UMC3 and Price Thermostat – In addition to personally controllable diffusers, some areas are typically shared amongst a larger group, for example a conference room or meeting room. Using DBV baskets controlled by UMC3 controller and a Price thermostat allows automatic flow adjustment and temperature regulation for these areas. The exact same diffusers (RFTD/RFDD) can be used in these areas to maintain consistency throughout the building.

RPN – Using several RPN baskets allows the building pressure management system to operate separate sub-plenums or adjacent main plenums at different pressures and gives each plenum the ultimate control over pressure. The RPN baskets are discretely placed under the exact same diffusers (RFTD/RFDD) to again maintain consistency throughout the building.

LFG Family – Any of the Price LFG Family of grilles (LFG, DFG, DFG-F, DFGL) can be used to treat perimeter and interior zones. This will add style to the space while keeping the UFAD system simple and maintaining a high level of durability throughout the life of the building. All of the LFG Family of diffusers are available with the same core styles and finishes to maintain a consistent look and feel.

FDBU with UMCB – The FDBU with UMCB is a perfect solution to treat perimeter zones for heating and cooling loads. The proven track record along with its inherent simplicity means you can be sure these terminal units and controllers will provide top notch service throughout the building's lifetime. A wide range of sizes, accessories, and sequences mean you will find a terminal unit that is perfectly suited to the application.



RFTD



# Underfloor Air Distribution Engineering Guide

## Typical Applications

### LARGE PUBLIC SPACES

#### Flexibility

As with offices and, flexibility to make changes in building arrangement are extremely important when designing the HVAC system. UFAD offers excellent flexibility to adapt the diffuser arrangement when library stacks, theatre seats, or furniture are reconfigured.

#### Energy Savings

Religious buildings, auditoria, and theatres often have high ceilings, increasing the energy savings potential that the stratification inherent of a UFAD system presents. In the case of theatres, high lighting loads at the ceiling present the opportunity for further energy savings in a stratified environment.

#### Quiet Operation

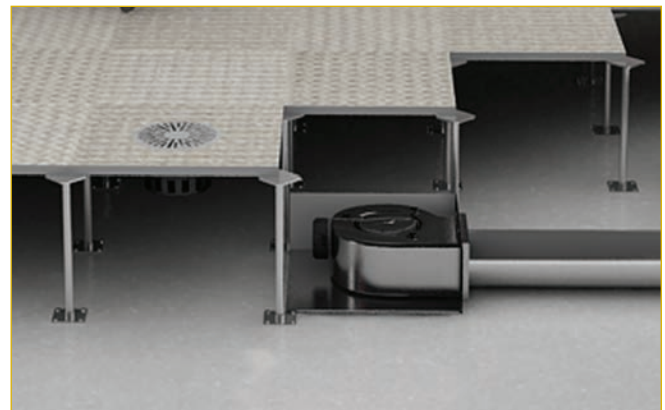
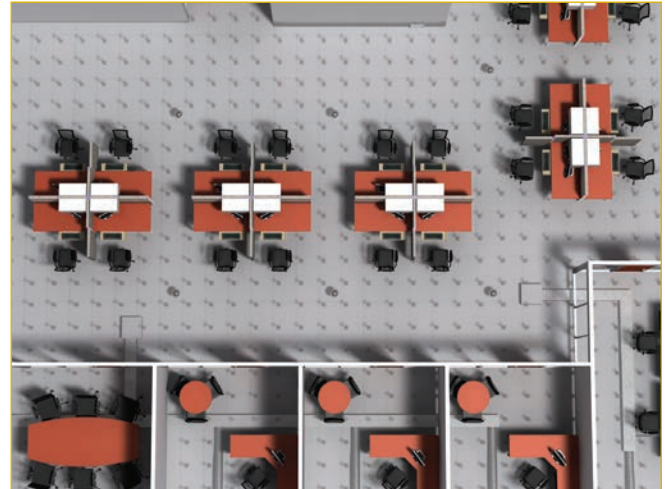
A critical design criterion in libraries and theatres is low noise levels. UFAD typically offers low noise levels, below 30 NC.

#### Products

RFTD/RFDD – Available in custom colours, both round floor diffusers can be utilized to provide accent or blend in with the building’s finishes. The high flow of RFTD lends itself to areas with high loading while the displacement flow pattern of the RFDD ensures optimal comfort for the space. Both diffusers generate remarkably low noise and can be used with any basket (DB, DBA, DBV) for various control strategies.

FDBU with UMCB – Simplicity and durability are found in the FDBU with UMCB controller. With their wide range of sizes, accessories, and sequences, there will be a perfect terminal unit for any application.

DGD – For variably loaded spaces, DGD grilles will spread the air in the plenum while allowing the system pressure to be easily regulated.



**DGD**



## Typical Applications

### CASINOS

Casinos are another application that can benefit heavily from UFAD due to the following advantages:

#### Indoor Air Quality

Removing contaminants, notably tobacco smoke, from the breathing area is vital for HVAC systems in casinos. UFAD is very effective at removing contaminants from the breathing area as fresh air is supplied directly into the breathing area and contaminants are exhausted above.

#### Flexibility

Like office buildings, there is a high degree of churn in casinos, as gaming equipment is often moved around the floor. The ability to quickly and easily adapt the HVAC system to changing loads is of critical importance.

#### Products

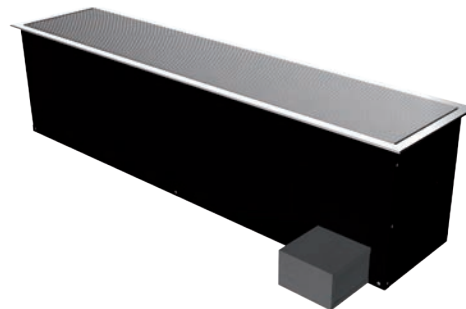
ARFTD/ARFHD – Aluminum round floor diffusers are perfectly suited for casino applications. With their high strength and durability, both the ARFTD and ARFHD will stand up to high mechanical loads and long term punishment. For casinos with high amounts of cigarette smoke or other pollutants, the displacement flows created by ARFHD are perfect for removing unhealthy toxins and allowing customers the cleanest air and most enjoyable experience.

DFG – The high strength of aluminum grilles combined with displacement flow patterns make DFG, DFG-F, and DFGL ideal for casinos. These square and rectangular grilles can augment or replace the round aluminum ARFHD grilles to allow ultimate performance regardless of the style choice.

LFGH Family – With a continuous grille, several LFGH, LFGH-RC, or LFGH-RCV will serve perimeter loads while maintaining a clean look. Because they draw only plenum air and the heater is built into the unit, no ductwork or terminal units are required, which means more floor space can be rearranged with minimal interference from equipment.



LFG-RC



## References

- Addison, M.S. & Nall, D.H. (2001). Cooling via Underfloor Air Distribution: Current Design Issues and Analysis Options. From *Cooling frontiers—The advanced edge of cooling research and applications in the built environment*. College of Architecture and Environmental Design, Arizona State University.
- Architectural Energy Corporation (n.d.). Underfloor Air Distribution and Access Floors. *Energy design resources design brief*. Boulder, CO: Architectural Energy Corporation.
- ASHRAE (2004). *Standard 90.1-2004—Energy standard for buildings except low-rise residential buildings*. Atlanta, GA: American Society for Heating, Refrigerating and Air Conditioning Engineers, Inc.
- ASHRAE (2006). *Standard 70-2006—Methods of testing the performance of air outlets and air inlets*. Atlanta, GA: American Society of Heating Refrigeration and Air-Conditioning Engineers.
- ASHRAE (2009). *ASHRAE handbook—Fundamentals*. Atlanta, GA: American Society for Heating, Refrigerating and Air Conditioning Engineers, Inc.
- ASHRAE (2010a). Standard 55-2010—*Thermal environmental conditions for human occupancy*. Atlanta, GA: American Society of Heating, Refrigeration and Air-Conditioning Engineers, Inc.
- ASHRAE (2010b). Standard 62.1-2010—*Ventilation for acceptable indoor air quality*. Atlanta, GA: American Society for Heating, Refrigerating and Air Conditioning Engineers, Inc.
- Bauman, F. (2003). *Underfloor air distribution (UFAD) design guide*. Atlanta, GA: American Society of Heating, Refrigeration and Air-Conditioning Engineers, Inc.
- Bauman, F., Jin, H. & Webster, T. (2006). Heat transfer pathways in underfloor air distribution (UFAD) systems. *ASHRAE Transactions* 112 (2). 567-580.
- Bauman, F., Pecora, P. & Webster, T. (1999). "How low can you go?"—*Air flow performance of low-height underfloor plenums* (CBE summary report). Berkeley, CA: Center for the Built Environment, Center for Environmental Design Research, University of California at Berkeley.
- Bauman, F., Schiavon, S., Webster, T., & Lee, K.H. (2010). Cooling load design tool for UFAD. *ASHRAE Journal*, 52 (9). 62-71
- Bauman, F., Webster, T., & Benedek, C. (2007). Cooling airflow design calculations for UFAD. *ASHRAE Journal*, 49 (10). 36-44.
- Bauman, F., Webster, T., Linden, P., & Buhl, F. (2007). *Energy performance of UFAD systems, final report to CEC PIER program*. Berkeley, CA: Center for the Built Environment, Center for Environmental Design Research, University of California at Berkeley.
- Chen, Q. & Glicksman, L. (2003). *System performance evaluation and design guidelines for displacement ventilation*. Atlanta, GA: American Society of Heating, Refrigeration and Air-Conditioning Engineers, Inc.
- Daly (2006). Underfloor vs. overhead: A comparative analysis of air distribution systems using the EnergyPlus simulation software. Thesis, University of California.
- Daly, A. (2002). Underfloor Air Distribution: Lessons Learned. *ASHRAE Journal*, 44 (5), 21-24.
- Filler, M. (2004). Best practices for underfloor air systems. *ASHRAE Journal*, 46 (10), 39-46.
- Hosni M.H. & Beck, B.T. (2009). Final report for *ASHRAE RP-1482: Update to measurements of office equipment heat gain data*. Atlanta, GA: American Society of Heating, Refrigeration and Air-Conditioning Engineers, Inc.
- Langdon, D. (2005). Conceptual cost model for office building—Underfloor air comparison study. Culver City, CA.
- Lin, Y.J.P. & Linden, P.F. (2005). A model for an under floor air distribution system. *Energy and Buildings*, 37, 399-409.
- Linden, P.F., Kanda, I., & Yamaguchi, D. (2004). Flow in an underfloor plenum. Proceedings from *SimBuild 2004*, Boulder, CO.
- Liu, Q.A. & Linden, P.F. (2008). The Energy Plus UFAD Module. Proceedings from the *3rd National Conference of IBPSA-USA*. Berkeley, California.

## References

- Liu, Q.A. & Linden, P.F. (2006). The fluid dynamics of an underfloor air distribution system. *Journal of Fluid Mechanics*, 554, 323-341.
- Loftness, V., Mathew, P., Gardner, G., Mondor, C., & Paul, T. (1999). Sustainable development alternatives for speculative office buildings: A case study of the SofferTech Office Building. Center for Building Performance and Diagnostics, Carnegie Mellon University.
- Loudermilk, K. (1999). Underfloor air distribution for office applications. *ASHRAE Transactions*, 105 (1), 605-613.
- Megerson, J.E. & Larson, C.R. (2008). Underfloor For Schools. *ASHRAE Journal*, 50 (5), 28-30.
- Price Industries (2011). *Price engineer's HVAC handbook—A comprehensive guide to HVAC fundamentals*. Winnipeg, MB: Price Industries Limited.
- Salter, C.M. & Waldeck, R.D. (2006). *Designing acoustically successful work places: A case study assessment of the speech privacy and sound isolation of spaces having underfloor air distribution systems*. Berkeley, CA: Center for the Built Environment.
- Schiavon, S, Bauman, F., Lee, K.H., & Webster, T. (2010). *Development of a simplified cooling load design tool for underfloor air distribution systems, final report to CEC PIER program*. Berkeley, CA: Center for the Built Environment, Center for Environmental Design Research, University of California at Berkeley.
- Schiavon, S, Lee, K.H., Bauman, F., & Webster, T. (2010). Influence of raised floor on zone design cooling load in commercial buildings. *Energy and Buildings*, 42 (8), 1182-1191.
- Schiavon, S, Lee, K.H., Bauman, F., & Webster, T. (in press). Simplified calculation method for design cooling loads in underfloor air distribution (UFAD) systems. Submitted to *Energy and Buildings*.
- Spitler, J.D. (2009). *Load calculation applications manual*. Atlanta, GA: American Society of Heating, Refrigeration and Air-Conditioning Engineers, Inc.
- Sreenivas, K.R. & Prasad, A.K. (2000). Vortex-dynamics model for entrainment in jets and plumes. *Physics of Fluids*, 12 (8), 2101-2107.
- Tan, L. & Landsberger, B.J. (2008). *Underfloor air distribution: An experimental comparison of air diffusion performance between underfloor air distribution and conventional overhead air distribution systems*. Alexandria, VA: National Center for Energy Management and Building Technologies.
- U.S. Department of Energy (2010). EnergyPlus input output reference. Retrieved from: [www.energyplus.gov](http://www.energyplus.gov)
- Webster, T., Bauman, F., Buhl, F., & Daly, A. (2008). Modeling underfloor air distribution (UFAD) systems. Proceedings from *SimBuild 2008*. Berkeley, CA.
- Webster, T., Bauman, F., Shi, M., & Reese, J. (2002). Thermal Stratification Performance of Underfloor Air Distribution (UFAD) Systems. Berkeley, CA: Center for the Built Environment, Center for Environmental Design and Research, University of California at Berkeley.
- Zhang, Z. & Chen, Q. (2006). Experimental measurements and numerical simulations of particle transport and distribution in ventilated rooms. *Atmospheric Environment*, 40 (18), 3396-3408.