

LBP/LBPH/LBM/LBMH

LINEAR BAR GRILLE



LBP/LBPH/LBM/LBMH

Linear Bar Grille

Designed for sidewall, sill, ceiling, and floor installations, extruded aluminum linear bar grilles combine architectural appeal with performance and versatility. With fixed bars parallel to the long dimension, linear bar grilles are a popular choice for continuous or perimeter applications.

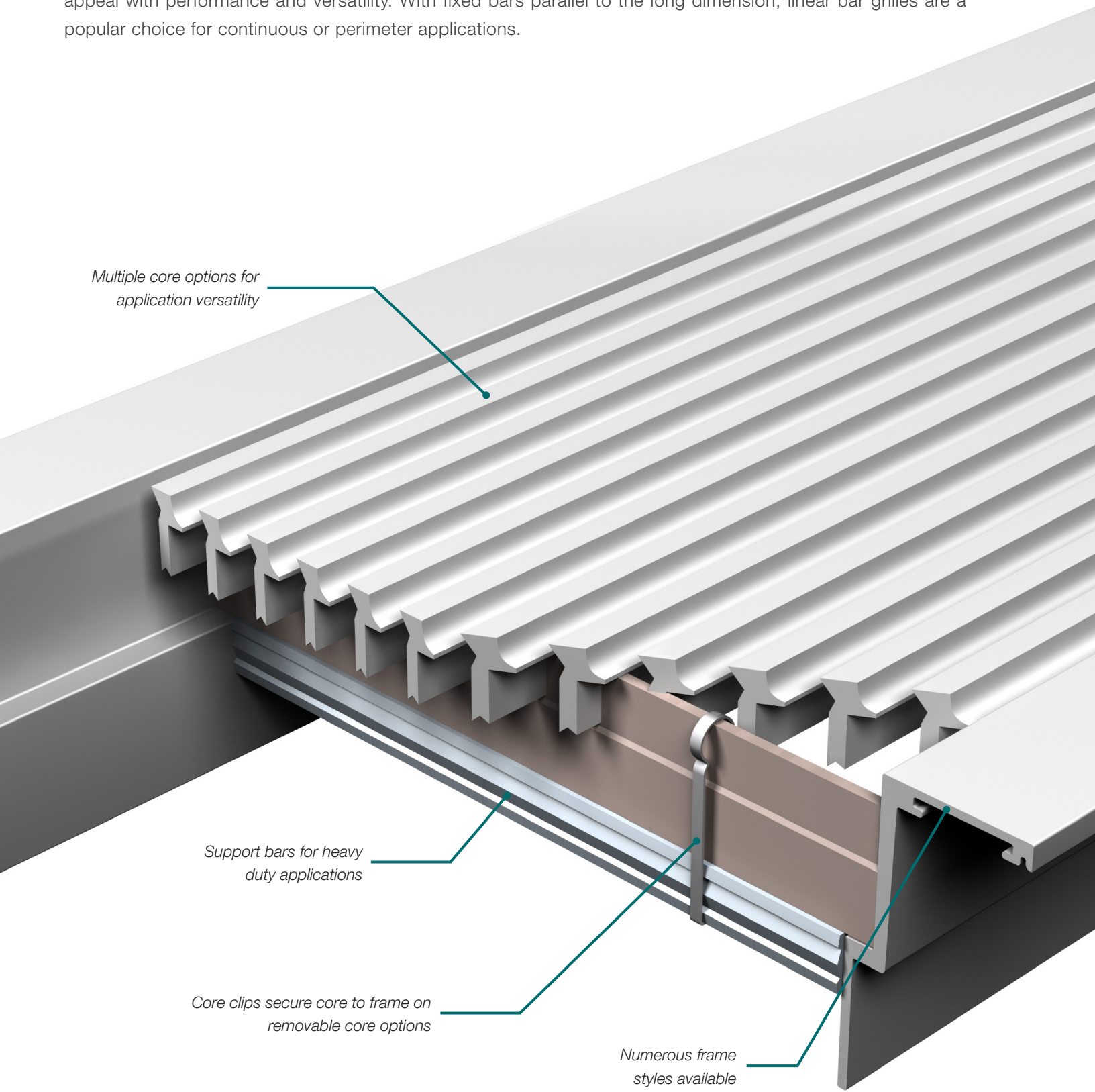

Multiple core options for application versatility

Support bars for heavy duty applications

Core clips secure core to frame on removable core options

Numerous frame styles available

HIGHLY CUSTOMIZABLE

- + With 10 different core styles, a variety of border styles and fastening types, as well as an assortment of optional accessories, linear bar grilles are customizable to suit performance, installation, and aesthetic requirements.

FLEXIBLE CONFIGURATIONS

- + For a smooth, uninterrupted finish, linear bar grilles can be installed in long, continuous lengths. Flanged borders are provided with alignment plates to position grilles when multiple sections are required.
- + Individual mitered corner sections are available in flat, inside, and outside corner configurations. Ideal for perimeter applications, mitered corner sections provide a unique, architectural appearance.

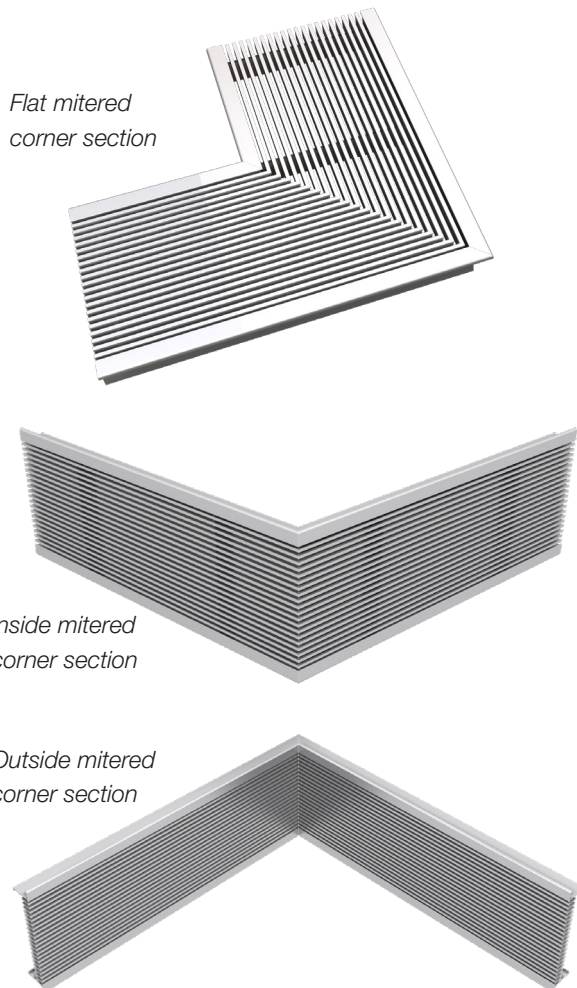

TYPICAL APPLICATIONS

Linear bar grilles are suitable for all supply or return ceiling, sidewall, floor and sill applications. High quality, extruded aluminum construction, clean lines and a continuous appearance make linear bar grilles an excellent choice for architectural spaces.

CONSTRUCTION OPTIONS



- + Construction
 - Pressed Core (LBP)
 - Heavy Duty Pressed Core (LBPH)
 - Mandrel Tube (LBM)
 - Heavy Duty Mandrel Tube (LBMH)
- + Blade Spacing
 - 1/4 in.
 - 7/16 in.
 - 1/2 in.
- + Blade Width
 - 3/32 in.
 - 1/8 in.
 - 3/16 in.
- + Blade Deflection
 - 0°, 15°, 30°
- + Finish
 - Various finish options available including anodized
- + Options
 - Mitered corners (MC)
 - Curved construction (LBM)

MULTIPLE CONSTRUCTION OPTIONS

Pressed Core

Extruded aluminum blades are pressed into a spacer bar.

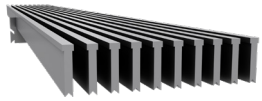
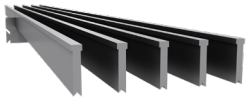
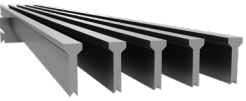
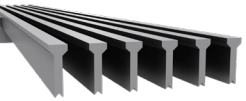
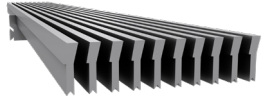
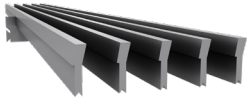
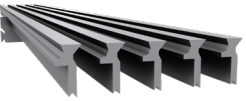
Pressed Core Styles

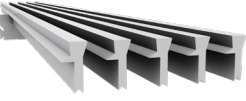
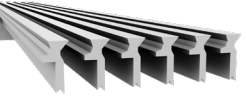
Deflection	¼ in. Blade Spacing	½ in. Blade Spacing		7/16 in. Blade Spacing
0°	 15A – 3/32 in. bars	 15B – 3/32 in. bars	 25B – 3/16 in. bars	 25C – 3/16 in. bars
15°	 16A – 1/8 in. bars	 16B – 1/8 in. bars	 26B – 3/16 in. bars	 26C – 3/16 in. bars
30°			 27B – 3/16 in. bars	 27C – 3/16 in. bars

Heavy Duty Pressed Core

- + The heavy duty extruded aluminum border features reinforcing support bars that allow this product to be used in light foot traffic floor applications.
- + The removable core is made of heavy duty extruded aluminum and is supplied with clips for securing the core in place.

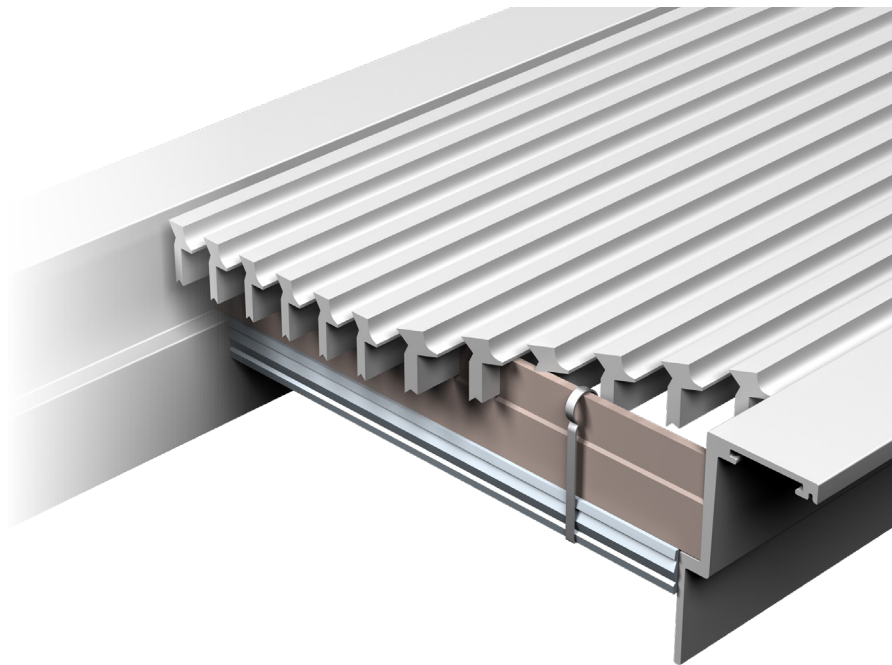

LBP/LBPH/LBM/LBMH

Linear Bar Grille

Mandrel Tube

Extruded aluminum blades are held in place with mandrel tubes.

Mandrel tube linear bar grilles offer the added architectural flexibility of curved sections. Grilles can include flat, concave, or convex curves and are supplied with matching straight sections when required. Curved grilles are exclusively available in the LBM model and core styles 15A, 15B and 25C.

Mandrel Tube Core Styles

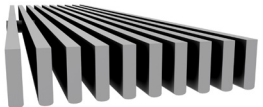
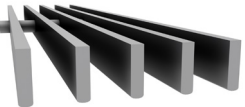
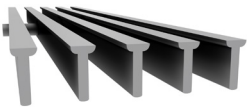
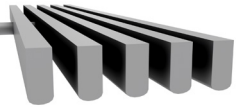
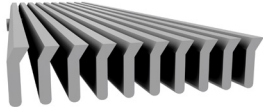
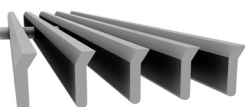
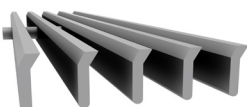
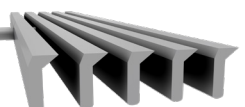
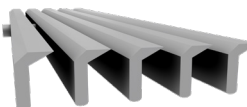
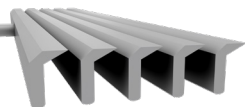
Deflection	¼ in. Blade Spacing		½ in. Blade Spacing	
	1/8 in. Bars	1/8 in. Bars	7/32 in. Bars	7/32 in. Bars
0°	 15A	 15B	 25B	 25C
15°	 16A	 16B	 26B	 26C
30°			 27B	 27C

Heavy Duty Mandrel Tube

- + The heavy duty, extruded aluminum border features reinforcing support bars that allow this product to be used in most floor applications.
- + The removable core is made of heavy duty, extruded aluminum blades and are secured to an integral mandrel tube.

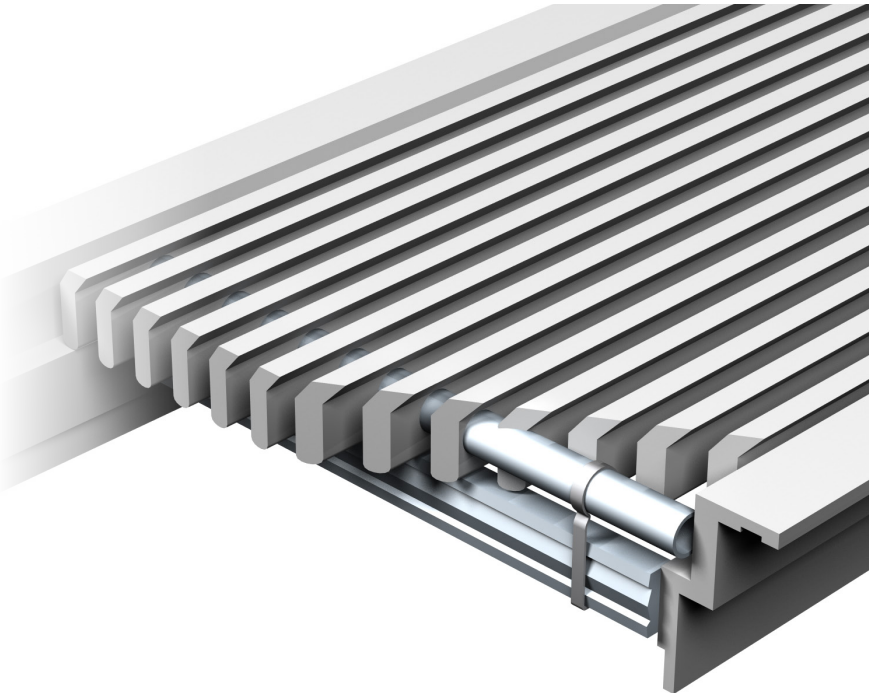

LBP/LBPH/LBM/LBMH

Linear Bar Grille

REMOVABLE CORE FOR HEAVY DUTY MODELS

- + For access behind the grille for cleaning, damper adjustment and vane adjustment, heavy-duty linear bar grilles are supplied with removable cores that are held in place with core clips.

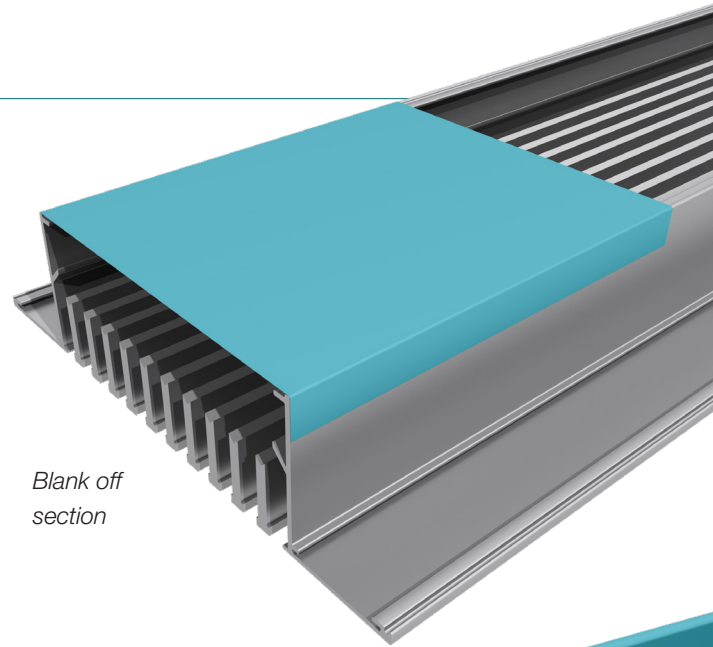
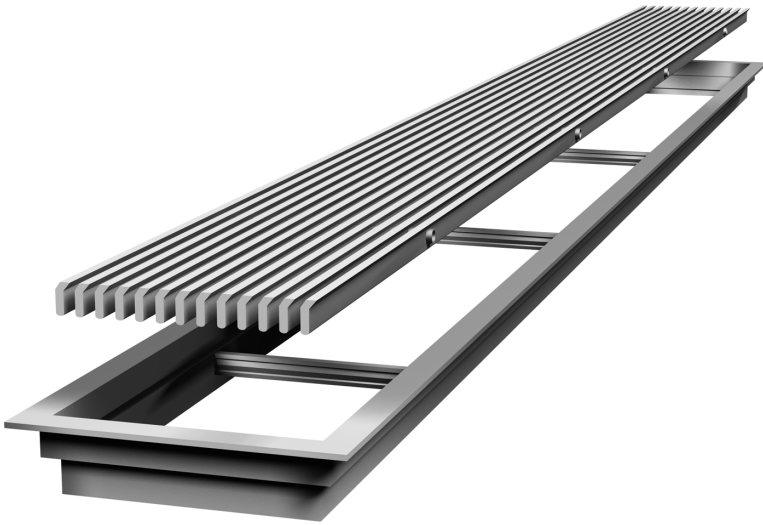

Blank off section

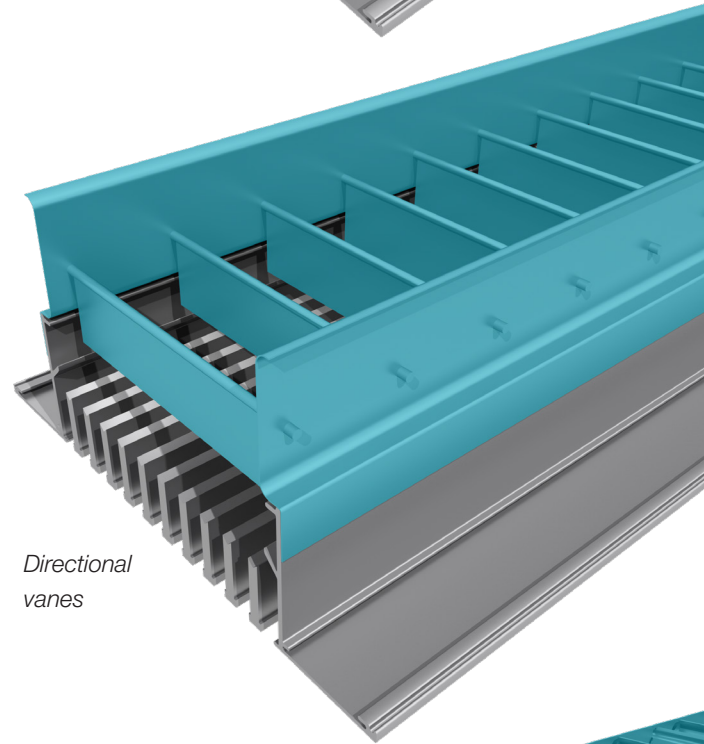

Directional vanes

OPTIONAL ACCESSORIES

- + Linear bar grilles are available with an assortment of accessories including:
 - Blank off sections for a continuous look without airflow.
 - Directional vanes to shorten throw and increase spread.
 - Dampers to adjust airflow volume.

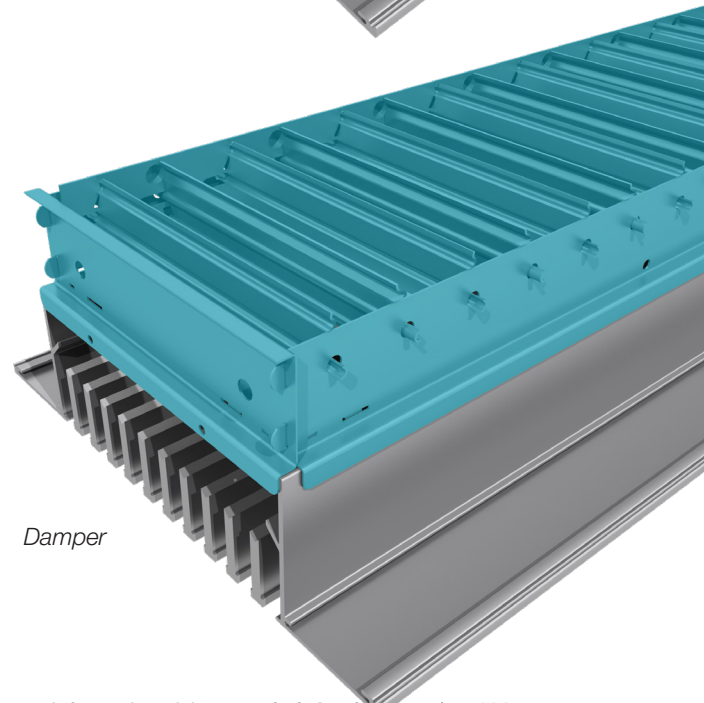

Damper

FRAME STYLES

Flanged Frame

Border: 250, 500, 750, 1000 and 1250

Designed to suit a wide array of installations including floor, sidewall, and ceiling; flanged borders can be laid into a ceiling grid or floor and attached using screw or concealed mounting. Available in 1 1/4", 1", 3/4", and 1/2" flange widths.

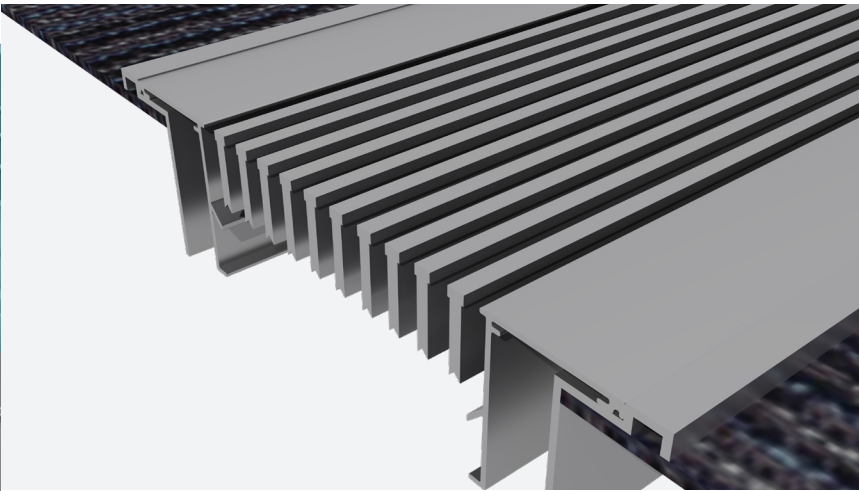

Spring Clip Frame

Spring clips: B and D

Featuring a friction-hold spring clip for easy removal of the grille, making it ideal for sill applications. The removable grille allows access to heaters or other equipment located behind the grille.

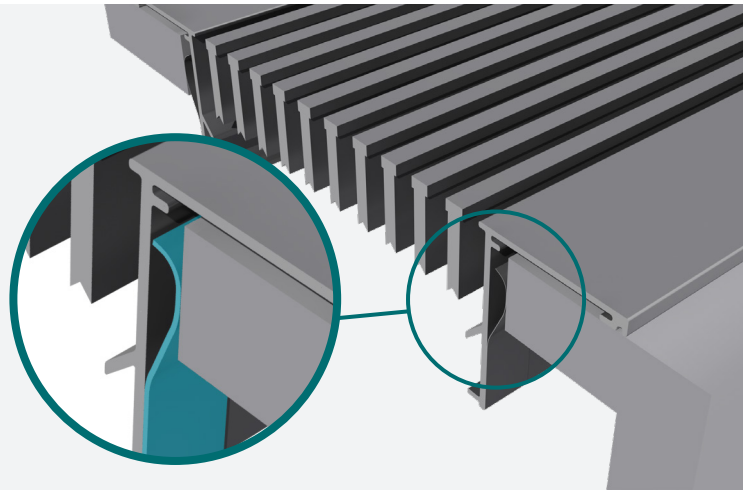

Concealed Plaster Frame

Border: CPF

The concealed plaster frame comes with a flange to be concealed with mud and tape. Concealing the outer frame leaves only the extruded blades visible from the room side for a unique architectural presence.

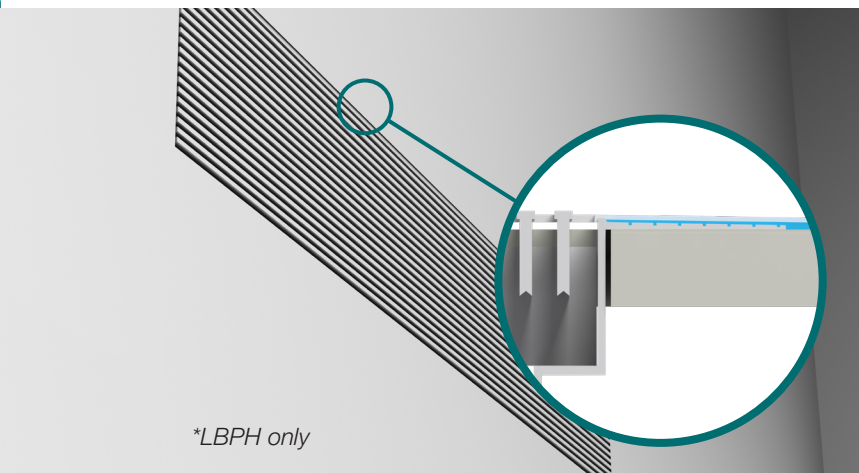

**LBPH only*

Narrow Frame

Border: 125 and 187

Specifically designed to create clean lines in architectural flooring including Terrazzo, marble, and concrete. The narrow border rests on brackets or ledges built into the flooring for easy, lay-in installation.

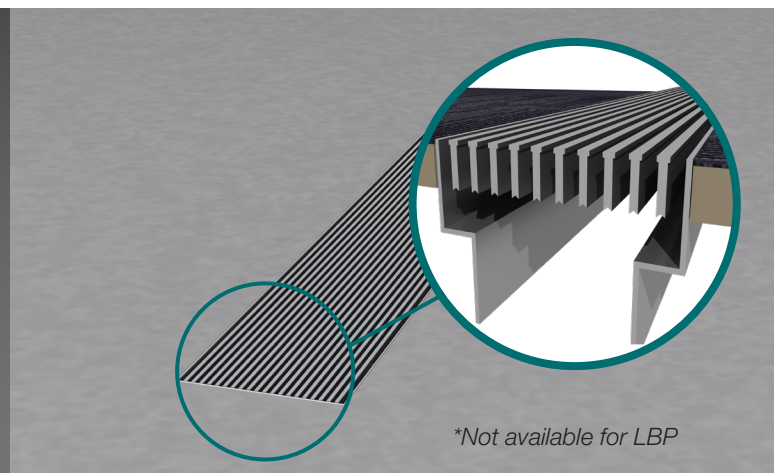

**Not available for LBP*

LBP/LBPH/LBM/LBMH

Linear Bar Grille

PERFORMANCE DATA

Linear Bar Grille (LBP/LBPH) – Core 15A

Size	Static Pressure (in. w.g.)		0.011	0.024	0.044	0.069	0.098	0.133	0.175	0.222
1½ in.	Flow Rate (cfm/ft)		12	19	25	31	37	43	50	56
	Sound (NC)		-	-	-	19	24	28	32	35
	Throw (ft)	Sill or Floor Sidewall	1-1-1 2-4-6	2-2-2 4-7-10	4-4-4 6-9-13	6-6-6 7-11-16	8-8-9 8-13-19	9-10-11 9-15-21	10-11-13 10-16-23	12-13-15 12-18-25
2 in.	Flow Rate (cfm/ft)		19	28	37	47	56	66	75	84
	Sound (NC)		-	-	-	18	23	28	31	35
	Throw (ft)	Sill or Floor Sidewall	1-1-1 3-5-7	4-4-4 5-8-11	6-6-6 7-11-15	9-9-9 9-14-19	11-11-12 11-16-22	12-13-15 12-18-25	14-15-17 14-20-27	15-17-19 15-22-29
2½ in.	Flow Rate (cfm/ft)		26	39	52	65	78	91	104	117
	Sound (NC)		-	-	-	19	24	29	33	36
	Throw (ft)	Sill or Floor Sidewall	1-1-1 4-6-8	5-5-5 6-9-12	8-8-8 8-12-16	10-10-11 10-15-20	13-14-15 13-18-24	15-16-17 15-21-27	16-18-20 16-22-30	20-20-21 20-27-34
3 in.	Flow Rate (cfm/ft)		33	50	66	83	100	116	133	149
	Sound (NC)		-	-	-	20	25	30	34	37
	Throw (ft)	Sill or Floor Sidewall	2-2-2 4-6-9	6-6-6 7-10-14	9-9-10 9-13-18	12-12-13 12-17-22	15-16-17 15-20-25	18-19-20 18-23-29	20-21-22 20-26-33	23-23-23 23-30-37
3½ in.	Flow Rate (cfm/ft)		41	61	82	102	122	143	163	184
	Sound (NC)		-	-	-	21	26	31	35	38
	Throw (ft)	Sill or Floor Sidewall	2-2-2 5-7-10	7-7-7 8-11-15	10-10-11 10-15-20	15-15-15 15-19-24	17-18-19 17-22-27	20-21-22 20-25-31	22-23-24 22-28-35	25-25-26 25-32-39
4 in.	Flow Rate (cfm/ft)		49	73	98	122	146	171	195	220
	Sound (NC)		-	-	16	22	28	32	36	39
	Throw (ft)	Sill or Floor Sidewall	3-3-3 6-8-11	8-8-8 9-12-16	12-12-13 12-16-20	15-15-16 15-20-25	19-19-20 19-24-29	21-22-23 21-26-32	24-24-25 24-30-36	26-26-27 26-33-40
5 in.	Flow Rate (cfm/ft)		63	94	125	157	188	220	251	282
	Sound (NC)		-	-	16	22	27	32	36	39
	Throw (ft)	Sill or Floor Sidewall	4-4-4 7-9-12	9-9-9 11-14-18	14-14-14 14-18-22	17-17-17 17-21-26	21-21-22 21-26-31	24-24-24 24-29-35	27-27-27 27-33-39	29-29-29 30-36-43
6 in.	Flow Rate (cfm/ft)		78	116	155	194	233	272	310	349
	Sound (NC)		-	-	18	24	29	34	37	41
	Throw (ft)	Sill or Floor Sidewall	5-5-5 8-10-13	10-10-10 12-15-19	15-15-15 15-19-23	18-18-18 20-24-28	23-23-23 23-27-32	25-25-25 26-31-37	28-28-29 29-34-40	31-31-31 33-39-45

For Performance Notes and Correction Factors, see end of section.

Linear Bar Grille (LBP/LBPH) – Core 16A

Size	Static Pressure (in. w.g.)		0.013	0.027	0.05	0.079	0.111	0.151	0.199	0.252
1½ in.	Flow Rate (cfm/ft)		14	20	27	34	41	48	54	61
	Sound (NC)		-	-	22	29	34	38	42	45
	Throw (ft)	Sill or Floor Sidewall	1-1-1 2-4-6	3-3-3 4-7-10	4-4-4 6-10-14	7-7-7 7-12-17	9-9-10 9-14-20	10-11-12 10-16-22	12-13-15 12-18-25	13-14-16 13-20-27
2 in.	Flow Rate (cfm/ft)		20	29	39	49	59	69	78	88
	Sound (NC)		-	-	20	26	31	36	40	43
	Throw (ft)	Sill or Floor Sidewall	1-1-1 3-5-7	4-4-4 5-8-11	6-6-6 7-11-15	9-9-9 9-14-19	11-11-12 11-16-22	12-13-15 12-18-25	14-16-18 14-20-27	15-17-19 15-22-30
2½ in.	Flow Rate (cfm/ft)		26	39	52	65	78	91	104	117
	Sound (NC)		-	-	20	26	31	36	40	43
	Throw (ft)	Sill or Floor Sidewall	1-1-1 4-6-8	5-5-5 6-9-12	8-8-8 8-12-16	10-10-11 10-15-20	13-14-15 13-19-24	14-15-17 14-20-26	17-18-20 17-23-30	19-20-21 19-26-33
3 in.	Flow Rate (cfm/ft)		33	49	66	82	98	115	131	148
	Sound (NC)		-	-	20	26	31	36	40	43
	Throw (ft)	Sill or Floor Sidewall	2-2-2 4-6-9	6-6-6 7-10-13	9-9-9 9-13-17	12-12-13 12-16-21	15-15-16 15-20-25	17-18-19 17-22-28	20-21-22 20-26-32	21-22-23 21-28-35
3½ in.	Flow Rate (cfm/ft)		40	59	79	99	119	138	158	178
	Sound (NC)		-	-	20	27	32	36	40	43
	Throw (ft)	Sill or Floor Sidewall	2-2-2 5-7-9	8-8-8 8-11-14	11-11-11 11-15-19	13-13-14 13-17-22	16-17-18 16-21-26	19-20-21 19-24-30	22-22-23 22-28-34	23-24-25 23-30-37
4 in.	Flow Rate (cfm/ft)		47	70	94	117	140	164	187	220
	Sound (NC)		-	-	21	27	33	37	41	44
	Throw (ft)	Sill or Floor Sidewall	3-3-3 5-7-10	9-9-9 9-12-15	12-12-12 12-16-20	15-15-15 15-19-24	18-19-20 19-23-28	21-21-22 21-26-32	23-24-25 23-29-35	25-25-26 25-32-39
5 in.	Flow Rate (cfm/ft)		61	91	121	152	182	212	243	274
	Sound (NC)		-	-	22	28	33	38	42	45
	Throw (ft)	Sill or Floor Sidewall	3-3-3 7-9-12	9-9-9 10-13-17	13-13-13 14-18-22	16-16-17 16-21-26	20-20-21 20-25-30	23-23-24 23-28-34	25-25-26 25-31-37	28-28-28 28-34-41
6 in.	Flow Rate (cfm/ft)		74	111	149	186	223	260	298	335
	Sound (NC)		-	-	22	29	34	39	42	46
	Throw (ft)	Sill or Floor Sidewall	4-4-4 8-10-13	10-10-10 11-14-18	14-14-14 15-19-23	18-18-18 19-23-27	22-22-22 23-27-31	25-25-25 25-30-35	28-28-28 28-33-39	30-30-30 31-37-43

For Performance Notes and Correction Factors, see end of section.

LBP/LBPH/LBM/LBMH

Linear Bar Grille

PERFORMANCE DATA

Linear Bar Grille (LBP/LBPH) – Core 15B

Size	Static Pressure (in. w.g.)		0.009	0.020	0.036	0.057	0.080	0.109	0.143	0.182
1½ in.	Flow Rate (cfm/ft)		14	21	28	35	42	49	56	63
	Sound (NC)		-	-	16	22	27	31	35	38
	Throw (ft)	Sill or Floor Sidewall	1-1-1 2-4-6	2-2-2 4-7-10	4-4-4 6-7-13	7-7-7 7-12-17	8-9-10 8-13-19	10-11-12 10-16-22	11-12-14 11-17-24	12-14-17 12-19-26
2 in.	Flow Rate (cfm/ft)		22	33	44	55	66	77	88	99
	Sound (NC)		-	-	-	18	23	27	31	34
	Throw (ft)	Sill or Floor Sidewall	1-1-1 3-5-7	4-4-4 5-8-12	7-7-7 7-11-16	9-9-10 9-14-20	11-11-12 11-17-23	13-14-16 13-19-26	14-16-18 14-21-28	15-17-20 15-22-30
2½ in.	Flow Rate (cfm/ft)		30	44	59	74	89	104	118	133
	Sound (NC)		-	-	-	17	22	26	30	33
	Throw (ft)	Sill or Floor Sidewall	1-1-1 4-6-8	5-5-5 6-9-13	9-9-9 9-13-17	11-11-12 11-16-21	13-14-15 13-18-24	15-16-17 15-21-28	18-19-20 17-24-31	20-21-23 20-27-35
3 in.	Flow Rate (cfm/ft)		38	58	77	96	115	134	154	173
	Sound (NC)		-	-	-	17	22	26	30	33
	Throw (ft)	Sill or Floor Sidewall	2-2-2 5-7-10	7-7-7 7-10-14	10-10-11 10-14-19	12-13-14 12-17-23	15-16-17 15-20-26	18-19-20 18-24-30	20-21-23 20-27-34	23-24-25 23-30-38
3½ in.	Flow Rate (cfm/ft)		46	69	93	116	139	162	186	209
	Sound (NC)		-	-	-	17	22	26	30	33
	Throw (ft)	Sill or Floor Sidewall	3-3-3 5-7-10	8-8-8 9-12-16	12-12-12 12-16-20	15-15-16 15-20-25	18-19-20 18-23-28	20-21-23 20-26-32	23-24-25 23-29-36	25-26-27 25-32-40
4 in.	Flow Rate (cfm/ft)		56	83	111	139	167	195	222	250
	Sound (NC)		-	-	-	18	23	27	31	34
	Throw (ft)	Sill or Floor Sidewall	3-3-3 6-8-11	9-9-9 10-13-17	13-13-13 13-17-21	16-16-17 16-20-25	20-20-21 20-25-30	22-23-24 22-28-34	24-25-26 24-30-37	27-27-27 28-35-42
5 in.	Flow Rate (cfm/ft)		72	107	143	179	215	250	286	322
	Sound (NC)		-	-	-	18	23	27	31	34
	Throw (ft)	Sill or Floor Sidewall	4-4-4 8-10-13	10-10-10 11-14-18	14-14-14 15-19-23	18-18-18 18-22-27	22-22-23 22-27-32	24-24-24 24-30-36	27-27-28 27-33-40	30-30-31 30-37-44
6 in.	Flow Rate (cfm/ft)		88	133	177	221	265	310	354	398
	Sound (NC)		-	-	-	19	24	28	32	35
	Throw (ft)	Sill or Floor Sidewall	5-5-5 9-12-15	10-10-10 13-16-20	15-15-15 16-20-24	18-18-18 20-24-29	23-23-23 24-29-34	25-25-25 28-33-39	28-28-28 30-35-41	31-31-31 34-40-46

For Performance Notes and Correction Factors, see end of section.

Linear Bar Grille (LBP/LBPH) – Core 16B

Size	Static Pressure (in. w.g.)		0.009	0.02	0.036	0.057	0.08	0.109	0.143	0.182
1½ in.	Flow Rate (cfm/ft)		16	23	31	39	47	55	62	70
	Sound (NC)		-	17	26	32	37	42	46	49
	Throw ft	Sill or Floor Sidewall	1-1-1 2-4-6	3-3-3 4-7-10	5-5-5 6-10-14	8-8-8 8-13-18	9-9-10 9-14-20	10-11-13 10-16-23	12-13-15 12-18-25	13-15-17 13-20-27
2 in.	Flow Rate (cfm/ft)		22	34	45	56	67	78	90	101
	Sound (NC)		-	-	19	25	30	35	39	43
	Throw ft	Sill or Floor Sidewall	1-1-1 3-5-7	4-4-4 5-8-12	7-7-7 7-11-16	9-9-10 9-14-20	11-12-13 11-17-23	12-14-16 12-18-25	14-16-18 14-20-27	15-17-20 15-22-30
2½ in.	Flow Rate (cfm/ft)		30	45	60	75	90	105	120	135
	Sound (NC)		-	-	18	24	29	34	38	42
	Throw ft	Sill or Floor Sidewall	1-1-1 4-6-8	5-5-5 6-9-13	8-8-9 8-12-17	11-11-12 11-16-21	13-14-15 13-19-25	15-16-18 15-21-27	17-19-21 17-24-31	20-21-22 20-27-35
3 in.	Flow Rate (cfm/ft)		37	56	74	93	112	130	149	167
	Sound (NC)		-	-	17	23	28	33	37	41
	Throw ft	Sill or Floor Sidewall	2-2-2 4-6-9	6-6-6 7-10-14	10-10-10 10-13-18	12-12-13 12-17-22	15-16-17 15-20-26	18-19-20 18-24-30	20-21-23 20-26-33	23-23-24 23-30-37
3½ in.	Flow Rate (cfm/ft)		45	68	90	113	136	158	181	203
	Sound (NC)		-	-	17	23	28	33	37	41
	Throw ft	Sill or Floor Sidewall	2-2-2 5-7-10	7-7-7 8-11-15	12-12-12 12-16-20	14-14-15 14-18-23	17-18-19 17-22-27	20-21-22 20-25-31	22-23-24 22-28-35	25-25-26 25-32-39
4 in.	Flow Rate (cfm/ft)		53	80	106	133	160	186	212	239
	Sound (NC)		-	-	18	24	29	34	38	42
	Throw ft	Sill or Floor Sidewall	3-3-3 6-8-11	8-8-9 9-12-16	13-13-13 13-17-21	15-15-16 15-19-24	19-19-20 19-24-29	22-22-23 22-27-33	24-24-25 24-30-36	26-26-27 25-33-40
5 in.	Flow Rate (cfm/ft)		69	104	138	173	208	242	277	312
	Sound (NC)		-	-	18	24	29	34	38	42
	Throw ft	Sill or Floor Sidewall	4-4-4 8-10-13	9-9-9 11-14-18	14-14-14 15-19-23	17-17-17 17-21-26	20-21-22 20-25-31	24-24-24 24-29-35	26-26-27 26-33-38	29-29-29 29-35-42
6 in.	Flow Rate (cfm/ft)		85	127	170	212	254	296	339	382
	Sound (NC)		-	-	18	24	29	34	38	42
	Throw ft	Sill or Floor Sidewall	5-5-5 9-11-14	10-10-10 13-16-20	15-15-15 16-20-24	18-18-18 20-24-28	23-23-23 23-27-32	25-25-25 25-30-36	28-28-28 28-33-39	30-30-30 31-37-43

For Performance Notes and Correction Factors, see end of section.

LBP/LBPH/LBM/LBMH

Linear Bar Grille

PERFORMANCE DATA

Linear Bar Grille (LBP/LBPH) – Core 25B/25C

Size	Static Pressure (in. w.g.)		0.01	0.022	0.04	0.063	0.089	0.121	0.159	0.202
1½ in.	Flow Rate (cfm/ft)		10	16	21	26	31	36	42	47
	Sound (NC)		-	-	-	19	24	29	33	36
	Throw (ft)	Sill or Floor* Sidewall	1-1-1 2-4-6	2-2-2 4-7-10	4-4-4 5-9-13	7-7-7 7-12-17	8-9-10 8-13-19	10-11-12 10-16-22	11-12-14 11-17-24	12-14-16 12-19-26
2 in.	Flow Rate (cfm/ft)		18	27	36	45	54	63	72	81
	Sound (NC)		-	-	-	18	23	28	32	35
	Throw (ft)	Sill or Floor* Sidewall	1-1-1 3-5-7	4-4-4 5-9-12	7-7-7 7-11-16	9-9-10 9-14-20	10-11-13 10-16-23	13-14-16 13-19-26	14-16-18 14-21-28	15-17-20 15-22-30
2½ in.	Flow Rate (cfm/ft)		26	40	53	66	79	92	106	119
	Sound (NC)		-	-	-	20	25	30	34	37
	Throw (ft)	Sill or Floor* Sidewall	2-2-2 4-6-9	6-6-6 6-9-12	8-8-9 8-12-17	11-12-13 11-16-22	13-14-16 13-19-25	15-17-19 15-21-28	18-20-22 18-25-32	21-22-23 21-28-36
3 in.	Flow Rate (cfm/ft)		35	53	70	88	106	123	141	158
	Sound (NC)		-	-	-	21	26	31	35	38
	Throw (ft)	Sill or Floor* Sidewall	2-2-2 5-7-10	7-7-7 7-11-15	10-10-11 10-14-19	12-13-15 12-17-23	15-16-18 15-21-27	18-19-21 18-24-31	20-22-24 20-27-34	24-24-25 24-31-39
3½ in.	Flow Rate (cfm/ft)		44	66	88	110	132	154	176	198
	Sound (NC)		-	-	-	22	27	32	36	39
	Throw (ft)	Sill or Floor* Sidewall	3-3-3 5-7-10	8-8-8 9-12-16	12-12-12 12-16-20	15-15-16 15-20-25	18-19-20 18-23-28	20-21-22 20-26-32	23-24-25 23-29-36	25-26-27 25-32-40
4 in.	Flow Rate (cfm/ft)		53	80	106	133	160	186	213	239
	Sound (NC)		-	-	-	23	28	33	37	40
	Throw (ft)	Sill or Floor* Sidewall	3-3-3 6-8-11	9-9-9 10-13-17	13-13-13 13-17-21	16-16-17 16-21-26	20-20-21 20-25-30	22-23-24 22-28-34	24-25-26 24-30-37	28-28-28 28-35-42
5 in.	Flow Rate (cfm/ft)		71	106	142	177	212	248	283	318
	Sound (NC)		-	-	-	24	29	34	38	41
	Throw (ft)	Sill or Floor* Sidewall	4-4-4 8-10-13	10-10-10 11-14-18	15-15-15 15-19-23	18-18-18 18-22-27	22-22-23 22-27-32	25-25-25 25-31-37	27-27-28 27-33-40	30-30-30 30-37-44
6 in.	Flow Rate (cfm/ft)		89	133	178	222	266	310	355	400
	Sound (NC)		-	-	-	25	30	35	39	42
	Throw (ft)	Sill or Floor* Sidewall	5-5-5 9-11-14	10-10-10 13-16-20	15-15-15 16-20-24	19-19-19 20-24-29	23-23-23 24-29-34	25-25-25 28-33-39	29-29-29 30-35-41	31-31-31 34-40-46

For Performance Notes and Correction Factors, see end of section.

* 1/2" core spacing (26B) not for use in floor applications.

Linear Bar Grille (LBP/LBPH) – Core 26B/26C

Size	Static Pressure (in. w.g.)		0.012	0.026	0.048	0.076	0.107	0.145	0.191	0.242
1½ in.	Flow Rate (cfm/ft)		12	19	25	31	37	43	50	56
	Sound (NC)		-	16	24	31	36	41	45	48
	Throw (ft)	Sill or Floor* Sidewall	1-1-1 2-4-6	3-3-3 4-7-10	5-5-5 6-10-14	7-7-7 7-12-17	9-9-10 9-14-20	10-11-12 10-16-23	12-13-15 12-18-25	13-15-17 13-20-27
2 in.	Flow Rate (cfm/ft)		19	29	38	48	58	67	77	86
	Sound (NC)		-	-	19	26	31	36	40	43
	Throw (ft)	Sill or Floor* Sidewall	1-1-1 3-5-7	4-4-4 5-8-12	7-7-7 7-11-16	9-9-10 9-14-20	11-12-13 11-17-24	14-14-15 13-19-26	15-16-18 15-22-29	16-18-20 16-23-31
2½ in.	Flow Rate (cfm/ft)		27	40	54	67	80	94	107	120
	Sound (NC)		-	-	19	26	31	36	40	43
	Throw (ft)	Sill or Floor* Sidewall	1-1-1 4-6-8	5-5-5 6-9-13	9-9-9 9-13-17	11-11-12 11-16-21	13-14-15 14-19-25	15-16-18 15-21-27	17-19-21 17-24-31	20-21-22 20-27-35
3 in.	Flow Rate (cfm/ft)		34	52	69	86	103	120	138	155
	Sound (NC)		-	-	19	26	31	36	40	43
	Throw (ft)	Sill or Floor* Sidewall	2-2-2 4-6-9	6-6-6 8-11-15	10-10-11 10-14-19	12-13-14 13-18-23	15-16-18 16-21-27	18-19-20 18-24-31	20-21-23 21-28-35	23-24-25 23-30-38
3½ in.	Flow Rate (cfm/ft)		42	63	84	105	126	147	168	189
	Sound (NC)		-	-	20	27	32	37	41	44
	Throw (ft)	Sill or Floor* Sidewall	2-2-2 6-8-11	8-8-8 9-12-16	11-11-12 12-16-21	15-15-15 14-19-24	17-18-19 18-23-29	21-21-22 21-27-33	22-23-25 23-29-36	25-25-26 25-32-40
4 in.	Flow Rate (cfm/ft)		51	76	102	127	152	178	203	228
	Sound (NC)		-	-	21	28	33	38	42	45
	Throw (ft)	Sill or Floor* Sidewall	3-3-3 6-9-12	9-9-9 10-13-17	13-13-13 13-17-22	16-16-17 15-20-25	19-20-21 19-24-30	22-22-23 22-28-34	24-25-26 25-31-38	27-27-27 28-36-42
5 in.	Flow Rate (cfm/ft)		67	100	134	167	200	234	267	301
	Sound (NC)		-	-	21	28	33	38	42	45
	Throw (ft)	Sill or Floor* Sidewall	4-4-4 8-11-14	10-10-10 11-15-19	14-14-14 15-19-24	18-18-18 19-23-28	21-21-22 21-26-32	24-24-25 24-30-36	26-27-28 26-32-39	30-30-30 29-36-43
6 in.	Flow Rate (cfm/ft)		84	126	168	210	252	294	336	378
	Sound (NC)		-	-	23	30	35	40	44	47
	Throw (ft)	Sill or Floor* Sidewall	5-5-5 9-12-15	10-10-10 14-17-21	15-15-15 17-21-25	19-19-19 20-24-29	23-23-23 24-29-34	25-25-25 27-32-38	28-28-29 29-35-41	31-31-31 32-38-44

For Performance Notes and Correction Factors, see end of section.

* 1/2" core spacing (26B) not for use in floor applications.

PERFORMANCE DATA

Linear Bar Grille (LBP/LBPH) – Core 27B/27C

Size	Static Pressure (in. w.g.)	0.012	0.026	0.048	0.076	0.107	0.145	0.191	0.242
1½ in.	Flow Rate (cfm/ft)	13	19	26	32	38	45	51	58
	Sound (NC)	-	16	24	31	36	41	45	48
	Throw (ft)	Sill or Floor* Sidewall	1-1-1 2-4-6	2-2-2 4-7-10	4-4-4 6-9-13	6-6-6 7-11-16	8-8-9 8-13-19	9-10-11 9-15-21	10-11-13 10-16-23
2 in.	Flow Rate (cfm/ft)	19	29	38	48	58	67	77	86
	Sound (NC)	-	-	20	26	31	36	40	43
	Throw (ft)	Sill or Floor* Sidewall	1-1-1 3-5-7	4-4-4 5-8-11	6-6-6 7-11-15	9-9-9 9-14-19	11-11-12 11-16-22	12-13-15 12-18-25	14-15-17 14-20-27
2½ in.	Flow Rate (cfm/ft)	26	39	52	65	77	91	104	117
	Sound (NC)	-	-	20	26	31	36	40	43
	Throw (ft)	Sill or Floor* Sidewall	1-1-1 4-6-8	5-5-5 6-9-12	8-8-8 8-12-16	10-10-11 10-15-20	13-14-15 13-19-24	15-16-17 14-20-26	16-18-20 17-23-30
3 in.	Flow Rate (cfm/ft)	33	50	66	83	100	116	133	149
	Sound (NC)	-	-	20	26	31	36	40	43
	Throw (ft)	Sill or Floor* Sidewall	2-2-2 4-6-9	6-6-6 7-10-13	9-9-10 9-13-17	12-12-13 12-16-21	15-16-17 15-20-25	18-19-20 17-22-28	20-21-22 20-26-32
3½ in.	Flow Rate (cfm/ft)	40	60	80	100	120	140	160	180
	Sound (NC)	-	-	20	27	32	36	40	43
	Throw (ft)	Sill or Floor* Sidewall	2-2-2 5-7-9	7-7-7 8-11-14	10-10-11 11-15-19	15-15-15 13-17-22	17-18-19 16-21-26	20-21-22 19-24-30	22-23-24 22-28-34
4 in.	Flow Rate (cfm/ft)	49	73	97	122	146	171	195	219
	Sound (NC)	-	-	21	27	33	37	41	44
	Throw (ft)	Sill or Floor* Sidewall	3-3-3 6-8-11	8-8-8 9-12-16	12-12-13 12-16-20	15-15-16 15-20-25	19-19-20 19-24-29	21-22-23 21-26-32	24-24-25 24-30-36
5 in.	Flow Rate (cfm/ft)	63	95	126	158	190	221	253	284
	Sound (NC)	-	-	22	28	33	38	42	45
	Throw (ft)	Sill or Floor* Sidewall	4-4-4 7-9-12	9-9-9 11-14-19	14-14-14 14-18-22	17-17-17 17-21-26	21-21-22 21-26-31	24-24-24 24-29-35	27-27-27 27-33-39
6 in.	Flow Rate (cfm/ft)	76	114	152	190	228	266	304	342
	Sound (NC)	-	-	22	29	34	39	42	46
	Throw (ft)	Sill or Floor* Sidewall	5-5-5 8-10-13	10-10-10 12-15-18	15-15-15 15-19-23	18-18-18 20-24-28	23-23-23 23-27-32	25-25-25 26-31-37	28-28-28 29-34-40

* 1/2" core spacing (26B) not for use in floor applications.

Performance Notes:

1. Tested in accordance with ASHRAE Standard 70 – 2006 "Method of Testing for Rating the Performance of Air Outlets and Inlets."
2. Airflow is in cubic feet per minute [cfm].
3. NC, sound pressure levels, are based on a room absorption of 10 dB re 10⁻¹² Watts, and a 10 ft. active section. The NC correction values for other lengths are listed in the table below
4. When used as a return air intake, the NC value given in the performance table will be increased by 4. For return air application, the negative static pressure will be 0.8 times the static pressure value as shown in the performance table.
5. Blanks "-" indicate an NC level below 15.
6. All pressures are in inches of water column [in. w.g.].
7. Pressures not listed can be calculated using the following formula:
P_{total} = P_{static} + P_{velocity}
8. Throw values are measured in feet for terminal velocities of:
150 fpm (minimum)
100 fpm (middle)
50 fpm (maximum)

9. These throw values are based on a 4 ft. active section of grille with a cooling temperature differential of 20°F. The multiplier factors listed in the table below are applicable for other lengths.

Throw Correction for Length (Multiply)

Active Length	Terminal Velocity		
	150 fpm	100 fpm	50 fpm
1 ft.	0.5	0.6	0.7
10 ft. or Continuous	1.6	1.4	1.2

10. 1/2" core spacing (15B, 16B, 25B, 26B, 27B) not for use in floor applications.

Active Length, ft	1	2	4	6	8	10	15	20	25	30
NC Correction	-10	-7	-4	-2	-1	0	+2	+3	+4	+5

LBP/LBPH/LBM/LBMH

Linear Bar Grille

PERFORMANCE DATA

Heavy Duty Mandrel Linear Bar Grille (LBMH) – Core 15A

Size	Static Pressure (in. w.g.)	0.011	0.024	0.044	0.069	0.098	0.133	0.175	0.222	0.275
1 ½ in.	Flow Rate (cfm/ft)	11	15	21	27	32	38	43	48	54
	Sound (NC)	-	-	-	17	21	26	30	33	36
2 in.	Flow Rate (cfm/ft)	17	25	34	43	51	60	68	77	86
	Sound (NC)	-	-	-	17	22	26	30	33	36
2 ½ in.	Flow Rate (cfm/ft)	23	35	47	59	71	82	95	106	118
	Sound (NC)	-	-	-	17	23	27	31	34	38
3 in.	Flow Rate (cfm/ft)	31	47	62	78	93	109	125	140	156
	Sound (NC)	-	-	-	20	25	29	33	37	39
3 ½ in.	Flow Rate (cfm/ft)	40	59	79	98	118	138	158	178	198
	Sound (NC)	-	-	-	21	26	31	35	38	41
4 in.	Flow Rate (cfm/ft)	46	69	93	116	138	161	183	208	230
	Sound (NC)	-	-	-	16	22	27	31	35	39
5 in.	Flow Rate (cfm/ft)	62	92	122	152	182	212	242	273	302
	Sound (NC)	-	-	-	18	24	29	33	37	41
6 in.	Flow Rate (cfm/ft)	76	113	152	190	228	266	302	342	380
	Sound (NC)	-	-	-	19	25	30	35	38	41
1 ½ in.	Throw (ft)	1-1-1	2-2-2	4-4-4	6-6-6	8-8-9	9-10-11	10-11-13	12-13-15	13-15-18
	Sill or Floor Sidewall	2-4-6	4-7-10	6-9-13	7-11-16	8-13-19	9-15-21	10-16-23	12-18-25	13-20-28
2 in.	Throw (ft)	1-1-1	4-4-4	6-6-6	9-9-9	11-11-12	12-13-15	14-15-17	15-17-19	16-18-20
	Sill or Floor Sidewall	3-5-7	5-8-11	7-11-15	9-14-19	11-16-22	12-18-25	14-20-27	15-22-29	16-24-32
2 ½ in.	Throw (ft)	1-1-1	5-5-5	8-8-8	10-10-11	13-14-15	15-16-17	16-18-20	20-20-21	22-22-22
	Sill or Floor Sidewall	4-6-8	6-9-12	8-12-16	10-15-20	13-18-24	15-21-27	16-22-30	20-24-34	22-30-38
3 in.	Throw (ft)	2-2-2	6-6-6	9-9-10	12-12-13	15-16-17	18-19-20	20-21-22	23-23-23	25-25-25
	Sill or Floor Sidewall	4-6-8	7-10-14	9-13-18	12-17-22	15-20-25	18-23-29	20-26-33	23-30-37	25-32-40
3 ½ in.	Throw (ft)	2-2-2	7-7-7	10-10-11	15-15-15	17-18-19	20-21-22	22-23-24	25-25-26	27-27-27
	Sill or Floor Sidewall	5-7-10	8-11-15	10-15-20	15-19-24	17-22-27	20-25-31	22-28-35	25-32-39	27-34-42
4 in.	Throw (ft)	3-3-3	8-8-8	12-12-13	15-15-16	19-19-20	21-22-23	24-24-25	26-26-27	29-29-30
	Sill or Floor Sidewall	6-8-11	9-12-16	12-16-20	15-20-25	19-24-29	21-26-32	24-30-36	26-33-40	30-37-44
5 in.	Throw (ft)	4-4-4	9-9-9	14-14-14	17-17-17	21-21-22	24-24-24	27-27-27	29-29-29	32-32-32
	Sill or Floor Sidewall	7-9-12	11-14-18	14-18-22	17-21-26	21-26-31	24-29-35	27-33-39	30-36-43	33-40-47
6 in.	Throw (ft)	5-5-5	10-10-10	15-15-15	18-18-18	23-23-23	25-25-25	28-28-29	31-31-31	34-34-34
	Sill or Floor Sidewall	8-10-13	12-15-19	15-19-23	20-24-28	23-27-32	26-31-37	29-34-40	33-40-45	37-43-49

For Performance Notes and Correction Factors, see end of section.

Heavy Duty Mandrel Linear Bar Grille (LBMH) – Core 16A

Size	Static Pressure (in. w.g.)	0.013	0.027	0.05	0.079	0.111	0.155	0.199	0.252	0.31
1 ½ in.	Flow Rate (cfm/ft)	12	19	25	31	38	44	50	56	62
	Sound (NC)	-	-	-	21	27	33	38	41	45
2 in.	Flow Rate (cfm/ft)	18	27	36	44	54	63	72	81	88
	Sound (NC)	-	-	-	17	24	30	35	38	42
2 ½ in.	Flow Rate (cfm/ft)	24	35	47	59	71	83	94	106	118
	Sound (NC)	-	-	-	16	23	29	34	37	41
3 in.	Flow Rate (cfm/ft)	29	43	58	72	87	101	116	130	144
	Sound (NC)	-	-	-	17	23	29	33	37	41
3 ½ in.	Flow Rate (cfm/ft)	35	52	70	87	104	122	139	157	174
	Sound (NC)	-	-	-	17	23	29	34	38	41
4 in.	Flow Rate (cfm/ft)	42	63	84	105	126	147	168	189	210
	Sound (NC)	-	-	-	18	25	30	34	39	42
5 in.	Flow Rate (cfm/ft)	54	81	108	135	162	189	216	243	270
	Sound (NC)	-	-	-	19	26	31	36	40	43
6 in.	Flow Rate (cfm/ft)	66	99	132	165	198	231	264	297	330
	Sound (NC)	-	-	-	19	25	31	36	40	43
1 ½ in.	Throw (ft)	1-1-1	3-3-3	4-4-4	7-7-7	9-9-10	10-11-12	12-13-15	13-14-16	14-16-18
	Sill or Floor Sidewall	2-4-6	4-7-10	6-10-14	7-12-17	9-14-20	10-16-22	12-18-25	13-20-27	14-22-30
2 in.	Throw (ft)	1-1-1	4-4-4	6-6-6	9-9-9	11-11-12	12-13-15	14-16-18	15-17-19	16-18-20
	Sill or Floor Sidewall	3-5-7	5-8-11	7-11-15	9-14-19	11-16-22	12-18-25	14-20-27	15-22-30	16-24-32
2 ½ in.	Throw (ft)	1-1-1	5-5-5	8-8-8	10-10-11	13-14-15	14-15-17	17-18-20	19-20-21	21-21-22
	Sill or Floor Sidewall	4-6-8	6-9-12	8-12-16	10-15-20	13-19-24	14-20-26	17-23-30	19-26-33	21-28-36
3 in.	Throw (ft)	2-2-2	6-6-6	9-9-9	12-12-13	15-15-16	17-18-19	20-21-22	21-22-23	23-23-24
	Sill or Floor Sidewall	4-6-9	7-10-13	9-13-17	12-16-21	15-20-25	17-22-28	20-26-32	21-28-35	23-31-39
3 ½ in.	Throw (ft)	2-2-2	8-8-8	11-11-11	13-13-14	16-17-18	19-20-21	22-22-23	23-24-25	26-26-26
	Sill or Floor Sidewall	5-7-9	8-11-14	11-15-19	13-17-22	16-21-26	19-24-30	22-28-34	23-30-37	26-33-41
4 in.	Throw (ft)	3-3-3	9-9-9	12-12-12	15-15-15	18-19-20	21-21-22	23-24-25	25-25-26	28-28-28
	Sill or Floor Sidewall	5-7-10	9-12-15	12-16-20	15-19-24	18-23-28	21-26-32	23-29-35	25-32-39	29-36-43
5 in.	Throw (ft)	4-4-4	9-9-9	13-13-13	16-16-17	20-20-21	23-23-24	25-25-26	28-28-28	31-31-31
	Sill or Floor Sidewall	7-9-12	10-13-17	14-18-22	16-21-26	20-25-30	23-28-34	25-31-37	28-34-41	31-38-45
6 in.	Throw (ft)	5-5-5	10-10-10	14-14-14	18-18-18	22-22-22	25-25-25	28-28-28	30-30-30	32-32-32
	Sill or Floor Sidewall	8-10-13	11-14-18	15-19-23	19-23-27	23-27-31	25-30-35	28-33-39	31-37-43	34-40-46

For Performance Notes and Correction Factors, see end of section.

LBP/LBPH/LBM/LBMH

Linear Bar Grille

PERFORMANCE DATA

Heavy Duty Mandrel Linear Bar Grille (LBMH) – Core 15B

Size	Static Pressure (in. w.g.)	0.009	0.02	0.036	0.057	0.08	0.109	0.143	0.182	0.225
1 ½ in.	Flow Rate (cfm/ft)	12	18	24	30	36	42	48	54	60
	Sound (NC)	-	-	-	-	19	24	27	30	34
	Throw (ft) Sill or Floor Sidewall	1-1-1 2-4-6	2-2-2 4-7-10	4-4-4 6-9-13	7-7-7 7-12-17	8-9-10 9-13-19	10-11-12 10-16-22	11-12-14 11-17-24	12-14-17 12-19-26	13-15-18 13-21-29
2 in.	Flow Rate (cfm/ft)	19	29	39	49	59	69	78	88	98
	Sound (NC)	-	-	-	-	20	24	28	31	35
	Throw (ft) Sill or Floor Sidewall	1-1-1 3-5-7	4-4-4 5-8-12	7-7-7 7-11-16	9-9-10 9-14-20	11-11-12 11-17-23	13-14-16 13-19-26	14-16-18 14-21-28	15-17-20 15-22-30	17-19-21 17-25-33
2 ½ in.	Flow Rate (cfm/ft)	27	40	54	67	80	94	107	121	134
	Sound (NC)	-	-	-	-	20	25	29	32	35
	Throw (ft) Sill or Floor Sidewall	1-1-1 4-6-8	5-5-5 6-9-13	9-9-9 9-13-17	11-11-12 11-16-21	13-14-15 13-18-24	15-16-17 15-21-28	18-19-20 17-24-31	20-21-23 20-27-35	23-24-25 23-31-39
3 in.	Flow Rate (cfm/ft)	36	53	71	89	107	125	142	160	178
	Sound (NC)	-	-	-	17	23	27	31	34	37
	Throw (ft) Sill or Floor Sidewall	2-2-2 5-7-10	7-7-7 7-10-14	10-10-11 10-14-19	12-13-14 12-17-23	15-16-17 15-20-26	18-19-20 18-24-30	20-21-23 20-27-34	23-24-25 23-30-38	25-25-26 25-33-41
3 ½ in.	Flow Rate (cfm/ft)	44	67	89	111	133	156	178	200	222
	Sound (NC)	-	-	-	19	24	28	32	36	39
	Throw (ft) Sill or Floor Sidewall	3-3-3 5-7-10	8-8-8 9-12-16	12-12-12 12-16-20	15-15-16 15-20-25	18-19-20 18-23-28	20-21-23 20-26-32	23-24-25 23-29-36	25-26-27 25-32-40	29-29-29 29-36-44
4 in.	Flow Rate (cfm/ft)	53	79	106	132	159	185	212	238	264
	Sound (NC)	-	-	-	20	25	29	33	37	40
	Throw (ft) Sill or Floor Sidewall	3-3-3 6-8-11	9-9-9 10-13-17	13-13-13 13-17-21	16-16-17 16-20-25	20-20-21 20-25-30	22-23-24 22-28-34	24-25-26 24-30-37	27-27-27 28-35-42	30-30-30 31-38-45
5 in.	Flow Rate (cfm/ft)	69	104	138	173	208	242	277	312	346
	Sound (NC)	-	-	-	21	27	31	35	38	41
	Throw (ft) Sill or Floor Sidewall	4-4-4 8-10-13	10-10-10 11-14-18	14-14-14 15-19-23	18-18-18 18-22-27	22-22-23 22-27-32	24-24-24 24-30-36	27-27-28 27-33-40	30-30-31 30-37-44	32-32-32 34-41-48
6 in.	Flow Rate (cfm/ft)	86	129	173	216	259	303	346	389	432
	Sound (NC)	-	-	16	23	28	32	36	39	42
	Throw (ft) Sill or Floor Sidewall	5-5-5 9-12-15	10-10-10 13-16-20	15-15-15 16-20-24	18-18-18 20-24-29	23-23-23 24-29-34	25-25-25 29-33-39	28-28-28 30-35-41	31-31-31 34-40-46	32-32-32 38-44-50

For Performance Notes and Correction Factors, see end of section.

Heavy Duty Mandrel Linear Bar Grille (LBMH) - Core 16B

Size	Static Pressure (in. w.g.)	0.009	0.02	0.036	0.057	0.08	0.109	0.143	0.182	0.225
1 ½ in.	Flow Rate (cfm/ft)	12	21	28	35	41	49	56	63	70
	Sound (NC)	-	-	17	23	28	33	37	41	44
	Throw (ft) Sill or Floor Sidewall	1-1-1 2-4-6	3-3-3 4-7-10	5-5-5 6-10-14	8-8-8 8-13-18	9-9-10 9-14-20	10-11-13 10-16-23	12-13-15 12-18-25	13-15-17 13-20-27	14-16-18 14-22-30
2 in.	Flow Rate (cfm/ft)	20	30	40	50	60	70	80	90	100
	Sound (NC)	-	-	-	20	25	30	34	38	40
	Throw (ft) Sill or Floor Sidewall	1-1-1 3-5-7	4-4-4 5-8-12	7-7-7 7-11-16	9-9-10 9-14-20	11-12-13 11-17-23	12-14-16 12-18-25	14-16-18 14-20-27	15-17-20 15-22-30	18-19-21 18-26-34
2 ½ in.	Flow Rate (cfm/ft)	27	40	54	67	80	94	108	121	134
	Sound (NC)	-	-	-	20	25	30	34	37	41
	Throw (ft) Sill or Floor Sidewall	1-1-1 4-6-8	5-5-5 6-9-13	8-8-9 9-12-17	11-11-12 11-16-21	13-14-15 13-19-25	15-16-18 15-21-27	17-19-21 17-24-31	20-21-22 20-27-35	22-22-23 22-30-38
3 in.	Flow Rate (cfm/ft)	33	49	66	82	98	115	131	148	164
	Sound (NC)	-	-	-	19	25	30	33	37	40
	Throw (ft) Sill or Floor Sidewall	2-2-2 4-6-9	6-6-6 7-10-14	10-10-10 10-13-18	12-12-13 12-17-22	15-16-17 15-20-26	18-19-20 18-24-30	20-21-23 20-26-33	23-23-24 23-30-37	25-25-25 25-32-40
3 ½ in.	Flow Rate (cfm/ft)	40	59	80	99	119	138	158	178	198
	Sound (NC)	-	-	-	20	25	29	33	37	40
	Throw (ft) Sill or Floor Sidewall	2-2-2 5-7-10	7-7-7 8-11-15	12-12-12 12-16-20	14-14-15 14-18-23	17-18-19 17-22-27	20-21-22 20-25-31	22-23-24 22-28-35	25-25-26 25-32-39	27-27-27 27-34-42
4 in.	Flow Rate (cfm/ft)	48	72	96	120	144	168	192	216	240
	Sound (NC)	-	-	-	21	26	31	35	38	42
	Throw (ft) Sill or Floor Sidewall	3-3-3 6-8-11	8-8-9 9-12-16	13-13-13 13-17-21	15-15-16 15-19-24	19-19-20 19-24-29	22-22-23 22-27-33	24-24-25 24-30-36	26-26-27 26-33-40	30-30-30 30-37-44
5 in.	Flow Rate (cfm/ft)	62	93	124	154	185	216	247	277	308
	Sound (NC)	-	-	-	22	27	32	36	39	42
	Throw (ft) Sill or Floor Sidewall	4-4-4 8-10-13	9-9-9 11-14-18	14-14-14 15-19-23	17-17-17 17-21-26	20-21-22 20-25-31	24-24-24 24-29-35	26-26-27 26-33-38	29-29-29 29-35-42	32-32-32 32-39-46
6 in.	Flow Rate (cfm/ft)	75	113	150	188	226	263	301	338	376
	Sound (NC)	-	-	-	22	27	32	36	39	42
	Throw (ft) Sill or Floor Sidewall	5-5-5 9-11-14	10-10-10 13-16-20	15-15-15 16-20-24	18-18-18 20-24-28	23-23-23 23-27-32	25-25-25 25-30-36	28-28-28 28-33-39	30-30-30 31-37-43	34-34-34 35-41-47

For Performance Notes and Correction Factors, see end of section.

LBP/LBPH/LBM/LBMH

Linear Bar Grille

PERFORMANCE DATA

Heavy Duty Mandrel Linear Bar Grille (LBMH) Core 25B/25C

Size	Static Pressure (in. w.g.)	0.01	0.022	0.04	0.063	0.089	0.121	0.159	0.202	0.25
1 1/2 in.	Flow Rate (cfm/ft)	12	18	24	30	36	42	48	54	60
	Sound (NC)	-	-	-	-	18	24	28	31	34
1 1/2 in.	Throw (ft)	1-1-1	2-2-2	4-4-4	7-7-7	8-9-10	10-11-12	11-12-13	12-14-16	14-16-18
	Sill or Floor Sidewall	2-4-6	4-7-10	5-9-13	7-12-17	8-13-19	10-16-22	11-17-24	12-19-26	14-21-29
2 in.	Flow Rate (cfm/ft)	20	29	39	49	59	69	79	89	98
	Sound (NC)	-	-	-	-	21	25	29	33	36
2 in.	Throw (ft)	1-1-1	4-4-4	7-7-7	9-9-10	10-11-13	13-14-16	14-16-18	15-17-20	17-19-21
	Sill or Floor Sidewall	3-5-7	5-9-12	7-11-16	9-14-20	10-16-23	13-19-26	14-21-28	15-22-30	17-25-33
2 1/2 in.	Flow Rate (cfm/ft)	28	43	57	71	85	99	117	125	142
	Sound (NC)	-	-	-	18	23	27	32	34	37
2 1/2 in.	Throw (ft)	2-2-2	6-6-6	8-8-9	11-12-13	13-14-16	15-17-19	18-20-22	21-22-23	22-23-24
	Sill or Floor Sidewall	4-6-9	6-9-12	8-12-17	11-16-22	13-19-25	15-21-28	18-25-32	21-28-36	22-30-39
3 in.	Flow Rate (cfm/ft)	38	57	76	95	113	132	151	170	190
	Sound (NC)	-	-	-	20	25	30	33	36	40
3 in.	Throw (ft)	2-2-2	7-7-7	10-10-11	12-13-15	15-16-18	18-19-21	20-22-24	24-24-25	26-26-27
	Sill or Floor Sidewall	5-7-10	7-11-15	10-14-19	12-17-23	15-21-27	18-24-31	20-27-34	24-31-39	26-34-42
3 1/2 in.	Flow Rate (cfm/ft)	45	68	91	114	133	159	184	205	228
	Sound (NC)	-	-	-	20	25	30	34	37	41
3 1/2 in.	Throw (ft)	3-3-3	8-8-8	12-12-12	15-15-16	18-19-20	20-21-22	23-24-25	25-26-27	29-29-29
	Sill or Floor Sidewall	5-7-10	9-12-16	12-16-20	15-20-25	18-23-28	20-26-32	23-29-36	25-32-40	29-36-44
4 in.	Flow Rate (cfm/ft)	54	81	108	135	162	189	216	243	270
	Sound (NC)	-	-	-	21	26	31	34	38	41
4 in.	Throw (ft)	3-3-3	9-9-9	13-13-13	16-16-17	20-20-21	23-23-24	24-25-26	28-28-28	31-31-31
	Sill or Floor Sidewall	6-8-11	10-13-17	13-17-21	16-21-26	20-25-30	22-28-34	24-30-37	28-35-42	31-38-46
5 in.	Flow Rate (cfm/ft)	72	108	144	180	216	252	289	324	360
	Sound (NC)	-	-	17	23	28	33	37	40	43
5 in.	Throw (ft)	4-4-4	10-10-10	15-15-15	18-18-18	22-22-23	25-25-25	27-27-28	30-30-30	34-34-34
	Sill or Floor Sidewall	8-10-13	11-14-18	15-19-23	18-22-27	22-27-32	25-31-37	27-33-40	30-37-44	34-41-48
6 in.	Flow Rate (cfm/ft)	90	135	180	225	270	314	360	404	450
	Sound (NC)	-	-	17	24	30	34	38	41	45
6 in.	Throw (ft)	5-5-5	10-10-10	15-15-15	19-19-19	23-23-23	25-25-25	29-29-29	31-31-31	36-36-36
	Sill or Floor Sidewall	9-11-14	13-16-20	16-20-24	20-24-29	24-29-34	28-33-39	30-35-41	34-40-46	38-44-50

For Performance Notes and Correction Factors, see end of section.

Heavy Duty Mandrel Linear Bar Grille (LBMH) Core 26B/26C

Size	Static Pressure (in. w.g.)	0.012	0.026	0.048	0.076	0.107	0.145	0.191	0.242	0.3
1 1/2 in.	Flow Rate (cfm/ft)	13	19	26	32	39	45	51	58	64
	Sound (NC)	-	-	19	25	31	36	40	43	46
1 1/2 in.	Throw (ft)	1-1-1	3-3-3	5-5-5	7-7-7	9-9-10	10-11-12	12-13-15	13-15-17	14-16-18
	Sill or Floor Sidewall	2-4-6	4-7-10	6-10-14	7-12-17	9-14-20	10-16-23	12-18-25	13-20-27	14-22-30
2 in.	Flow Rate (cfm/ft)	19	29	39	48	58	67	77	87	96
	Sound (NC)	-	-	16	23	29	33	37	41	44
2 in.	Throw (ft)	1-1-1	4-4-4	7-7-7	9-9-10	11-12-13	13-14-15	15-16-18	16-18-20	17-19-22
	Sill or Floor Sidewall	3-5-7	5-8-12	7-11-16	9-14-20	11-17-24	13-19-26	15-22-29	16-23-31	17-25-34
2 1/2 in.	Flow Rate (cfm/ft)	26	40	53	66	79	92	105	119	132
	Sound (NC)	-	-	16	23	28	33	37	41	45
2 1/2 in.	Throw (ft)	1-1-1	5-5-5	9-9-9	11-11-12	13-14-15	15-16-18	17-19-21	20-21-22	22-22-23
	Sill or Floor Sidewall	4-6-8	6-9-13	9-13-17	11-16-21	13-18-24	15-21-27	17-24-31	20-27-34	22-29-38
3 in.	Flow Rate (cfm/ft)	34	51	68	85	102	119	136	152	170
	Sound (NC)	-	-	16	23	29	34	38	41	45
3 in.	Throw (ft)	2-2-2	6-6-6	10-10-11	12-13-14	15-16-18	18-19-20	20-21-23	23-24-25	25-25-25
	Sill or Floor Sidewall	4-6-9	7-10-14	10-14-19	12-17-22	15-20-26	18-24-30	20-27-33	23-30-37	25-33-40
3 1/2 in.	Flow Rate (cfm/ft)	42	63	84	106	126	148	169	190	212
	Sound (NC)	-	-	18	25	30	36	40	43	47
3 1/2 in.	Throw (ft)	2-2-2	8-8-8	11-11-12	15-15-15	17-18-19	21-21-22	23-23-25	25-25-26	28-28-29
	Sill or Floor Sidewall	5-7-10	8-11-15	11-15-20	14-19-24	17-22-28	21-27-33	22-28-35	25-31-39	28-35-43
4 in.	Flow Rate (cfm/ft)	50	75	100	125	150	175	200	225	250
	Sound (NC)	-	-	19	25	31	35	40	44	47
4 in.	Throw (ft)	3-3-3	9-9-9	13-13-13	16-16-17	19-20-21	22-22-23	24-25-26	27-27-27	30-30-30
	Sill or Floor Sidewall	6-8-11	10-13-17	13-17-21	16-20-25	19-24-29	22-28-33	24-30-37	27-35-41	30-37-44
5 in.	Flow Rate (cfm/ft)	66	99	132	165	198	231	264	297	330
	Sound (NC)	-	-	20	27	33	38	42	46	48
5 in.	Throw (ft)	4-4-4	10-10-10	14-14-14	18-18-18	21-21-22	24-24-25	26-27-28	30-30-30	32-32-32
	Sill or Floor Sidewall	8-11-13	11-15-18	14-18-23	18-22-27	21-29-31	24-30-35	26-32-39	30-35-43	32-38-46
6 in.	Flow Rate (cfm/ft)	84	126	168	210	252	294	336	378	420
	Sound (NC)	-	-	22	29	35	40	43	47	50
6 in.	Throw (ft)	5-5-5	10-10-10	15-15-15	19-19-19	23-23-23	25-25-25	28-28-29	31-31-31	35-35-35
	Sill or Floor Sidewall	9-12-15	13-16-20	17-21-25	20-24-29	23-28-33	26-31-37	28-34-40	30-37-44	35-41-47

For Performance Notes and Correction Factors, see end of section.

PERFORMANCE DATA

Heavy Duty Mandrel Linear Bar Grille (LBMH) Core 27B/27C

Size	Static Pressure (in. w.g.)	0.012	0.026	0.048	0.076	0.107	0.145	0.191	0.242
1 ½ in.	Flow Rate (cfm/ft)	13	19	26	32	38	45	51	58
	Sound (NC)	-	16	24	31	36	41	45	48
	Throw (ft)	Sill or Floor 1-1-1 Sidewall 2-4-6	2-2-2 4-7-10	4-4-4 6-9-13	6-6-6 7-11-16	8-8-9	9-10-11 8-13-19	9-10-11 9-15-21	10-11-13 10-16-23
2 in.	Flow Rate (cfm/ft)	19	29	38	48	58	67	77	86
	Sound (NC)	-	-	20	26	31	36	40	43
	Throw (ft)	Sill or Floor 1-1-1 Sidewall 3-5-7	4-4-4 5-8-11	6-6-6 7-11-15	9-9-9 9-14-19	11-11-12 11-16-22	12-13-15 12-18-25	14-15-17 14-20-27	15-17-19 15-22-30
2 ½ in.	Flow Rate (cfm/ft)	26	39	52	65	77	91	104	117
	Sound (NC)	-	-	20	26	31	36	40	43
	Throw (ft)	Sill or Floor 1-1-1 Sidewall 4-6-8	5-5-5 6-9-12	8-8-8 8-12-16	10-10-11 10-15-20	13-14-15 13-19-24	15-16-17 14-20-26	16-18-20 17-23-30	20-20-21 19-26-33
3 in.	Flow Rate (cfm/ft)	33	50	66	83	100	116	133	149
	Sound (NC)	-	-	20	26	31	36	40	43
	Throw (ft)	Sill or Floor 2-2-2 Sidewall 4-6-9	6-6-6 7-10-13	9-9-10 9-13-17	12-12-13 12-16-21	15-16-17 15-20-25	18-19-20 17-22-28	20-21-22 20-26-32	23-23-23 21-28-35
3 ½ in.	Flow Rate (cfm/ft)	40	60	80	100	120	140	160	180
	Sound (NC)	-	-	20	27	32	36	40	43
	Throw (ft)	Sill or Floor 2-2-2 Sidewall 5-7-9	7-7-7 8-11-14	10-10-11 11-15-19	15-15-15 13-17-22	17-18-19 16-21-26	20-21-22 19-24-30	22-23-24 22-28-34	25-25-26 23-30-37
4 in.	Flow Rate (cfm/ft)	49	73	97	122	146	171	195	219
	Sound (NC)	-	-	21	27	33	37	41	44
	Throw (ft)	Sill or Floor 3-3-3 Sidewall 6-8-11	8-8-8 9-1-16	12-12-13 12-16-20	15-15-16 15-20-25	19-19-20 19-24-29	21-22-23 21-26-32	24-24-25 24-30-36	26-26-27 26-33-40
5 in.	Flow Rate (cfm/ft)	63	95	126	158	190	221	253	284
	Sound (NC)	-	-	22	28	33	38	42	45
	Throw (ft)	Sill or Floor 4-4-4 Sidewall 7-9-12	9-9-9 11-14-19	14-14-14 14-18-22	17-17-17 17-21-26	21-21-22 21-26-31	24-24-24 24-29-35	27-27-27 27-33-39	29-29-29 30-36-43
6 in.	Flow Rate (cfm/ft)	76	114	152	190	228	266	304	342
	Sound (NC)	-	-	22	29	34	39	42	46
	Throw (ft)	Sill or Floor 5-5-5 Sidewall 8-10-13	10-10-10 12-15-18	15-15-15 15-19-23	18-18-18 20-24-28	23-23-23 23-27-32	25-25-25 26-31-37	28-28-28 29-34-40	31-31-31 33-39-45

Performance Notes

- Tested in accordance with ASHRAE Standard 70 – 2006 Method of Testing for Rating the Performance of Air Outlets and Inlets.
- Airflow is in cubic feet per minute [cfm].
- NC, sound pressure levels, are based on a room absorption of 10 dB re 10-12 Watts, and a 10 ft active section. The NC correction values for other lengths are listed in the table below.

NC Correction for Length											
Active Length, ft	1	2	4	6	8	10	15	20	25	30	
Correction	-10	-7	-4	-2	-1	0	+2	+3	+4	+5	
- When used as a return air intake, the NC value given in the performance table will be increased by 4. For return air application, the negative static pressure will be 0.8 times the static pressure value as shown in the performance table.
- Blanks "-" indicate an NC level below 15.
- All pressures are in inches of water column [in. w.g.].
- Pressures not listed can be calculated using the following formula:
 $P_{total} = P_{static} + P_{velocity}$
- Throw values are measured in feet for terminal velocities of:
 150 fpm (minimum)
 100 fpm (middle)
 50 fpm (maximum)
- These throw values are based on a 4 ft active section of grille with a cooling temperature differential of 20°F. The multiplier factors listed in the table below are applicable for other lengths.

Active Length	Terminal Velocity		
	150 fpm	100 fpm	50 fpm
1 ft.	0.5	0.6	0.7
10 ft. or Continuous	1.6	1.4	1.2
- 1/2" core spacing (15B, 16B, 25B, 26B, 27B) not for use in floor applications.



Product Improvement is a continuing endeavour at Price. Therefore, specifications are subject to change without notice. Consult your Price Sales Representative for current specifications or more detailed information. Not all products may be available in all geographic areas. All goods described in this document are warranted as described in the Limited Warranty shown at priceindustries.com. The complete Price product catalog can be viewed online at priceindustries.com.