

GRILLE FRAME STYLE SELECTION GUIDE

EGG CRATE GRILLES

Grille Name	Surface Mount				Lay in												Duct Mounted ED	
	Frame			Mounting Frame D	Frame						Panel							
	F	C	N		F	NF	17	CH	CORE	QR	3P	3PA	916P	916PA	17P	17PA		
80	X	X	X	X	X	X		X	X	X		X	X	X	X	X	X	X
81	X	X	X	X	X	X		X	X			X	X	X	X	X	X	X
82	X	X	X	X	X	X		X	X			X	X	X	X	X	X	X
85	X	X	X		X	X	X	X	X			X	X	X	X	X	X	X

SURFACE MOUNT

Frame

Border F – Flat Face

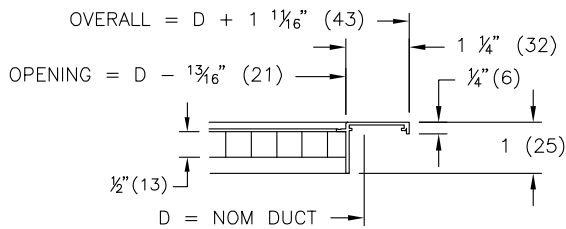

Border C – Curved Face

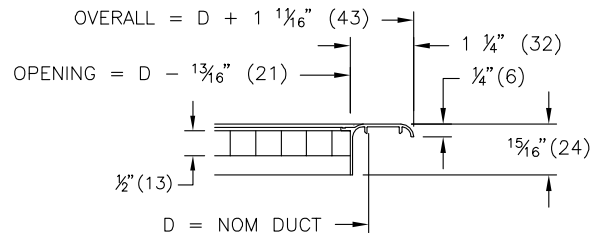

Border N – Narrow Flat Face

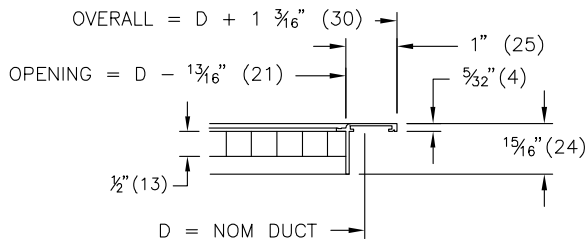

Mounting Frame and Exposed Duct

Mounting Frame D – For 'F' Frame Only

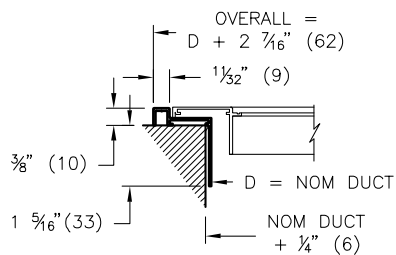

Border ED – Exposed Duct

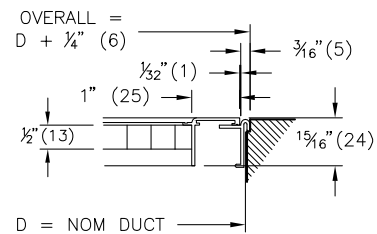

GRILLE FRAME STYLE SELECTION GUIDE

LAY IN

Frame

Border F – Flat Face

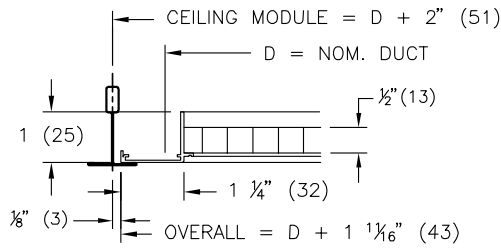

Border NF – Narrow Face

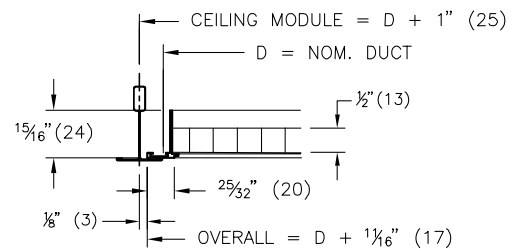

Border 17 – 9/16" Tegalor or Bolt Slot

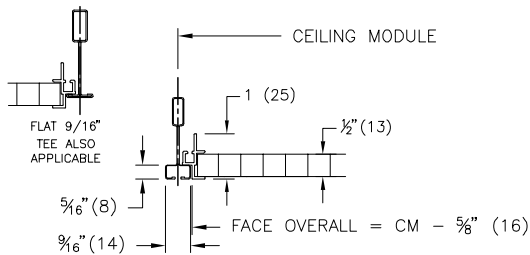

Border CH – Channel Border

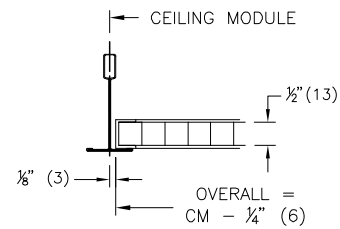

Border QR – Quick Release Fasteners

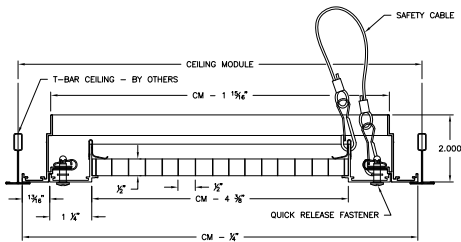

Core – Core Only

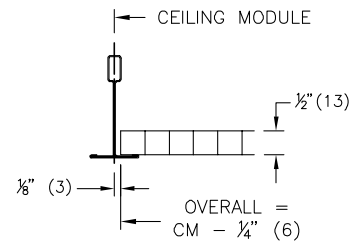

Panel

Border 3P/3PA – For 15/16" Flat Tee

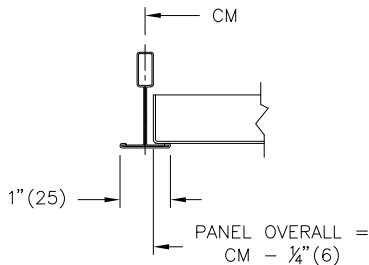

Border 916P/916PA – For 9/16" Flat Tee

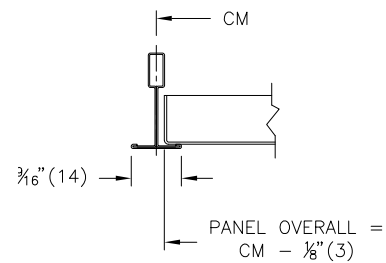

GRILLE FRAME STYLE SELECTION GUIDE

Border 17P/17PA – For 9/16" Tegular or Bolt Slot Tee

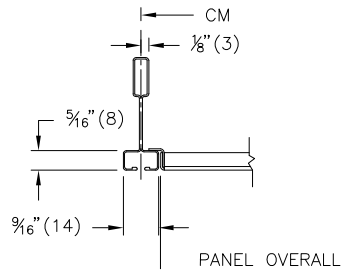

GRILLE FRAME STYLE SELECTION GUIDE

LOUVERED GRILLES

Grille Name	Surface Mount						Lay in										Duct Mounted	
	Frame				Mounting Frame		Frame			Panel								
	F	N	C	SF	D	T	F	NF	TB	3P	3PA	916P	916PA	17P	17PA	ED	SDF	
500	X	X			X	X	X				X		X		X		X	
600	X	X			X		X	X			X	X	X	X	X	X	X	
700	X	X			X	X	X											
540/640	X																	
21/22	X	X	X	X	X											X		
31/32	X	X	X	X	X											X		
60/70	X	X	X	X	X				X	X	X	X	X	X	X	X	X	

SURFACE MOUNT

Frame

Border F – Flat Face

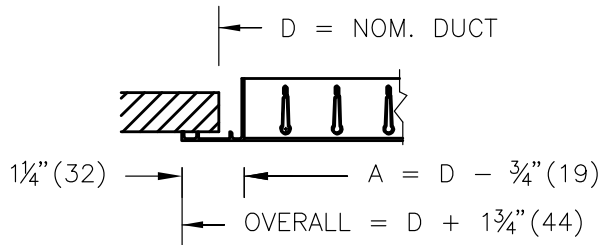

Border N – Narrow Face

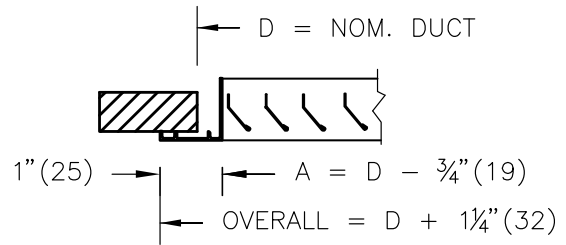

Border C – Curved Face

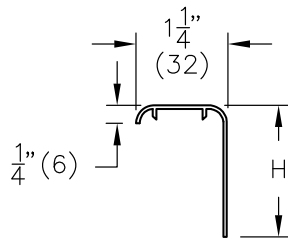

Border SF – Steel Frame

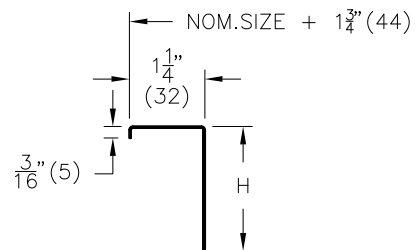

Mounting Frame and Exposed Duct

Mounting Frame D – For 'F' Frame Only

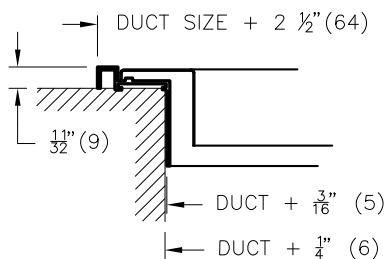

Mounting Frame T – For 'N' Frame Only

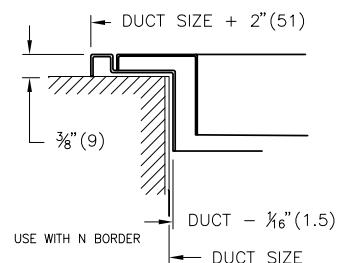

GRILLE FRAME STYLE SELECTION GUIDE

Border ED – Exposed Duct

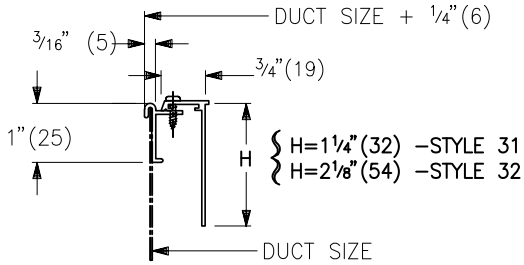

Border SDF – Spiral Duct Frame

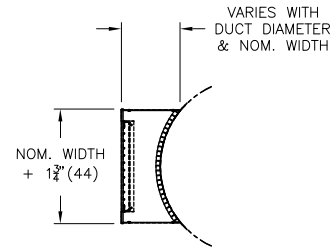

LAY IN Frame

Border F – Flat Face

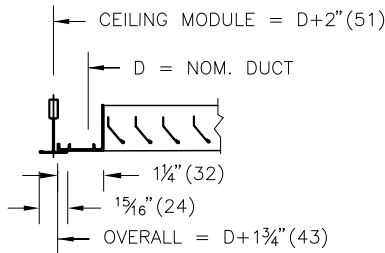

Border NF – Narrow Face

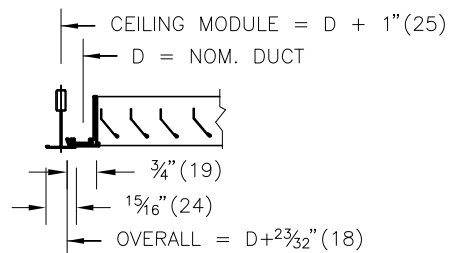

Border TB – T-Bar Lay-In

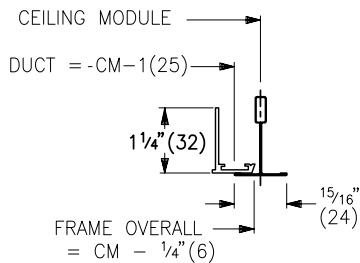

Panel

Border 3P/3PA – For 15/16" Flat Tee

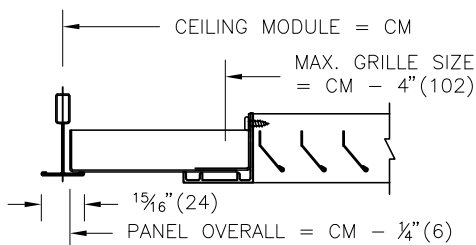

Border 916P/916PA – For 9/16" Flat Tee

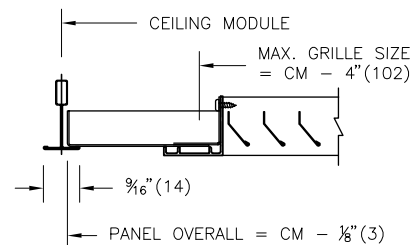

GRILLE FRAME STYLE SELECTION GUIDE

Border 17P/17PA – For 9/16" Tegular or Bolt Slot Tee

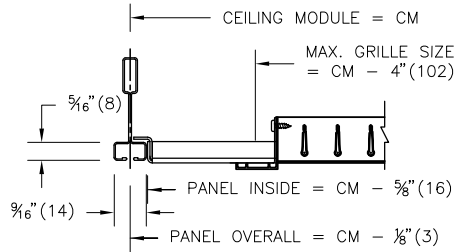

GRILLE FRAME STYLE SELECTION GUIDE

PERFORATED GRILLES

Grille Name	Surface Mount		Lay in				
	Frame	Mounting Frame	Frame	Panel			
	F	D	F	3P	3PA	916P	916PA
10/10A	X	X	X	X	X	X	X
10SS	X	X	X				

SURFACE MOUNT

Frame

Border F – Flat Face

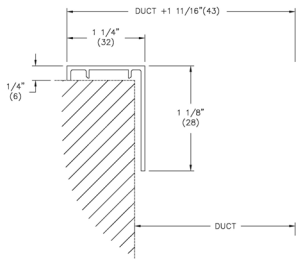

Mounting Frame

Mounting Frame D – For 'F' Frame Only

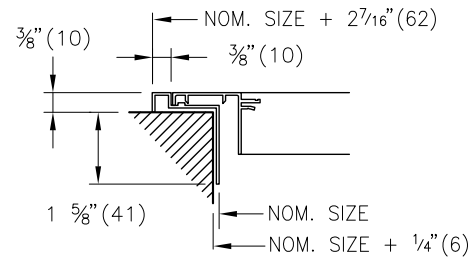

LAY-IN

Frame

Border F – Flat Face

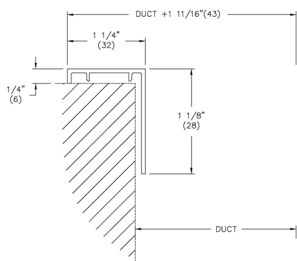

Panel

Border 3P/3PA – For 15/16" Flat Tee

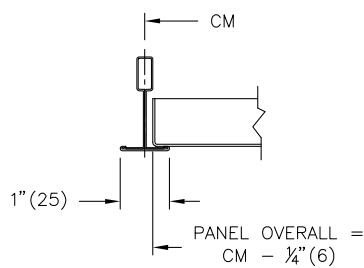

Border 916P/916PA – For 9/16" Flat Tee

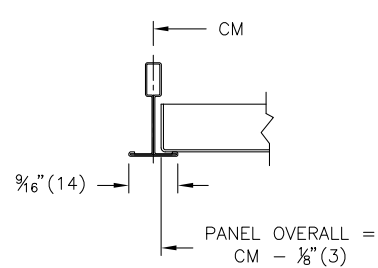

GRILLE FRAME STYLE SELECTION GUIDE

GYM GRILLES

Grille Name	Surface Mount	
	Frame	Mounting Frame
	F	D
90/91/93/95/96	X	X
97/98/99	X	
910/920	X	X

SURFACE MOUNT

Frame

Border F – Flat Face

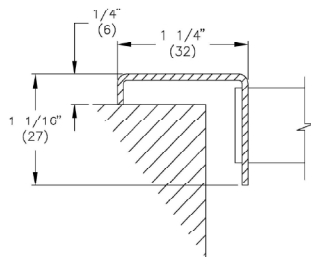

Mounting Frame

Mounting Frame D – For 'F' Frame Only

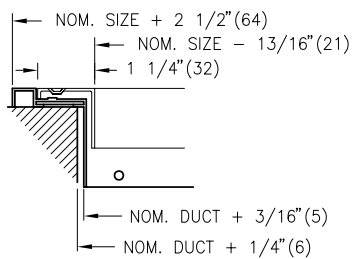

GRILLE FRAME STYLE SELECTION GUIDE

INDUSTRIAL GRILLES

Grille Name	Surface Mount			
	Frame			Mounting Frame
	F	TL	IF	D
150	X	X	X	X
152G	X			
301/302	X			X
301G/302G	X			
200			X	

SURFACE MOUNT

Frame

Border F – Flat Face

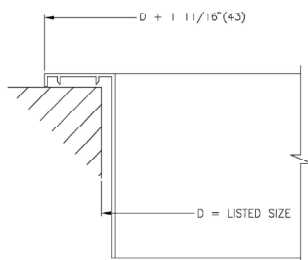

Border TL – Trunk-Latch with Quick Release

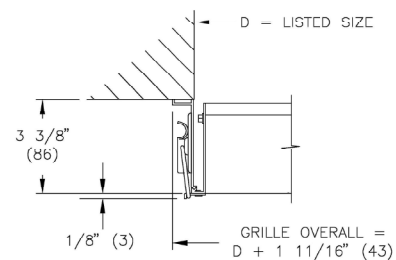

Border IF – Inverted Frame (No Latch)

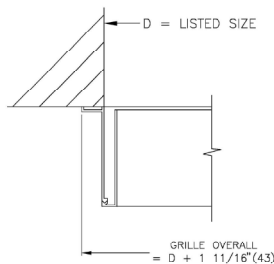

Mounting Frame

Mounting Frame D – For 'F' Frame Only

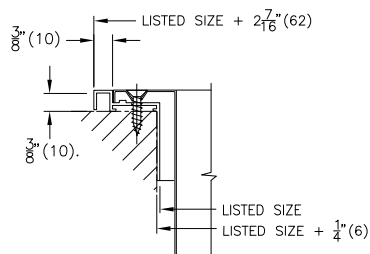

GRILLE FRAME STYLE ORDERING GUIDE

LAY-IN GRILLES

Grilles are typically used in sidewall applications, for this reason, grilles are ordered by duct size or hole opening size. When grilles are used for a lay-in application, careful consideration must be taken to ensure it will fit the ceiling module since the ordered size is the duct size.

Example 1:

530 - Steel Return Grille, 45 Deg Blades, 3/4" Spacing Qty: 1



Options	
Duct A	10.000
Duct B	10.000
Border	F - 1 1/4" (32) Flat Frame
Pattern	L - Front Louver Blades parallel to Long Dimension
Panel Sz. A	
Panel Sz. B	
Mounting	No Mounting Frame Required
Fastening	0 - No Screwholes (n/a sidewall applications)
Screen	None
Application	LI - T-Bar Lay-in
Finish	B12 - White - Powder Coat

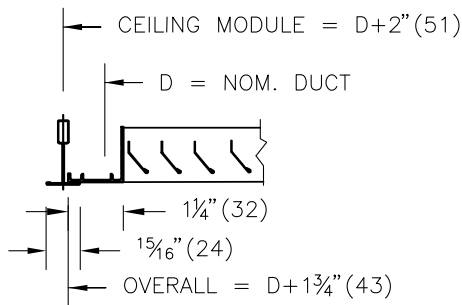

Grille 1:
Ordered Size (Duct Size) = 10" x 10"
Overall Size = 11 3/4" x 11 3/4"
Ceiling Module Size = 12" x 12"

530 - Steel Return Grille, 45 Deg Blades, 3/4" Spacing Qty: 1



Options	
Duct A	12.000
Duct B	12.000
Border	F - 1 1/4" (32) Flat Frame
Pattern	L - Front Louver Blades parallel to Long Dimension
Panel Sz. A	
Panel Sz. B	
Mounting	No Mounting Frame Required
Fastening	0 - No Screwholes (n/a sidewall applications)
Screen	None
Application	LI - T-Bar Lay-in
Finish	B12 - White - Powder Coat

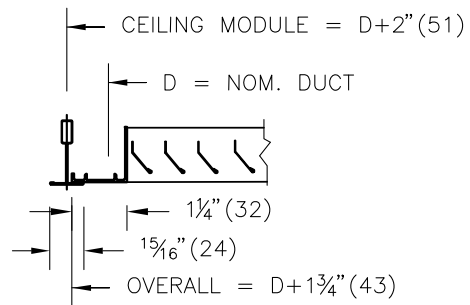

Grille 2:
Ordered Size (Duct Size) = 12" x 12"
Overall Size = 13 3/4" x 13 3/4"
Ceiling Module Size = 14" x 14"

GRILLE FRAME STYLE ORDERING GUIDE

Example 2:

Some grilles such as the Egg Crate Grilles have the calculation for ceiling module size included in the software.

80 - Egg Crate Grille, 1/2" X 1/2" X 1/2" Qty: 1



Options	
Dim A	23.000
Dim B	23.000
Application	LI - T-Bar Lay-in
Border	NF - 3/4" (19) Narrow Flat Frame
Panel Size	
Ceiling Module A	24
Ceiling Module B	24
Mounting Frame	No Mounting Frame Required
Fastening	0 - No Screwholes
Accessory	None Required
MRI	
Damper	
Finish	B12 - White - Powder Coat

80 - Egg Crate Grille, 1/2" X 1/2" X 1/2" Qty: 1



Options	
Dim A	48.000
Dim B	24.000
Application	LI - T-Bar Lay-in
Border	17 - For Fineline T-Bar
Panel Size	
Ceiling Module A	48
Ceiling Module B	24
Mounting Frame	No Mounting Frame Required
Fastening	0 - No Screwholes
Accessory	None Required
MRI	
Damper	
Finish	B12 - White - Powder Coat

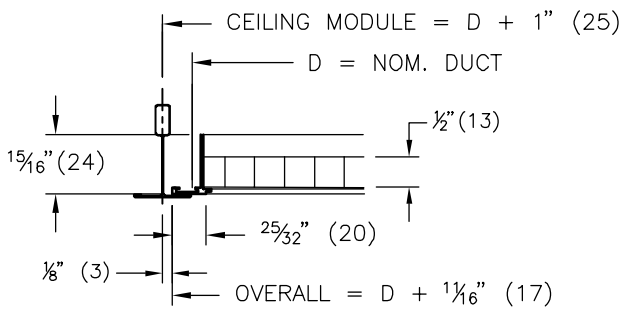

Grille 1:

Ordered Size (Duct Size) = 23" x 23"

Overall Size = 23 11/16" x 23 11/16"

Ceiling Module Size = 24" x 24"

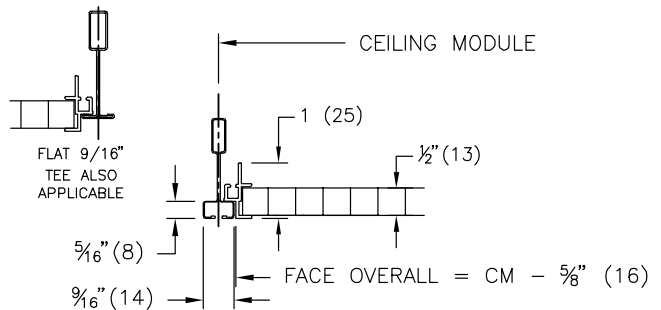

Grille 2:

Ordered Size (Duct Size) = 48" x 24"

Face Overall = 47 3/8" x 23 3/8"

Ceiling Module Size = 48" x 24"